

79 824

Volume 6  
September 2010  
**GIT**  
EMEA Edition

# SECURITY

MAGAZINE FOR SAFETY AND SECURITY



5

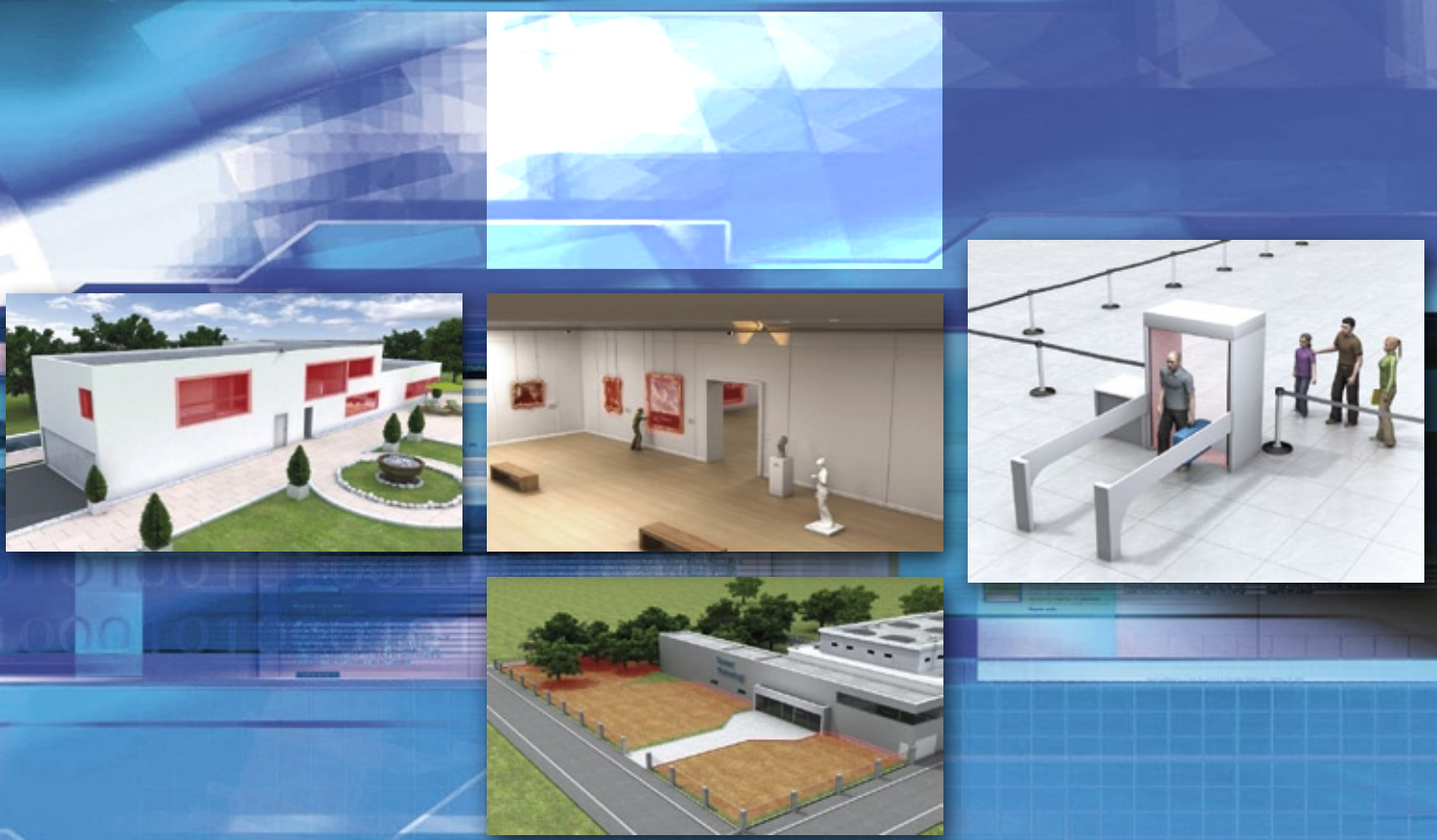

Security Essen Preview

GIT SECURITY AWARD 2011

Security for Public Transport

Video Cameras

Fire Protection

Access Control Systems

**COVER: SICK – Lasers in Security**



Hintergrund © Nmecliar / Fotolia.com



Help keep your business  
focused on results.

A good video surveillance system does more than just record events. It improves your ability to prevent and control them – allowing you to focus on your actual business.

Combine the new Axis range of compact affordable M-line network cameras with AXIS Camera Station, or with a video management solution from one of our partners, to create a truly effective HDTV surveillance solution.

Easy to install and operate, an Axis IP-Surveillance system delivers image quality that really proves your case, and the flexibility and scalability needed to accommodate your changing needs. So you will rest easy with a trouble-free video surveillance choice that lets you focus on what's important for you.

**Get the Axis picture. Stay one step ahead.**  
Visit [www.axis.com/focus](http://www.axis.com/focus)



AXIS M11, AXIS M32 and AXIS M10 network cameras, combined with AXIS Camera Station, provide a complete network video solution for up to 50 cameras that supports HDTV, H.264 and Power over Ethernet.





# Vigilant Cameras

Since the beginning of video surveillance it was always a dream to use the aid of computers to create a system that not only watches the environment and records videos but reacts to what happens in front of the camera. Video Content Analysis (VCA), the capability of automatically analyzing video to detect and determine temporal events can be seen as the automated equivalent of the biological processes that take place in our brain, when we watch a video on a monitor in a control room.

In the meantime a lot of different functionalities can be implemented in VCA. Video Motion Detection is one of the simpler forms where motion is detected with regard to a fixed background scene. Motion detection is now almost standard for IP and analog cameras. More advanced functionalities like video tracking and egomotion estimation are included in some of the most advanced cameras or can be used by utilising video management software. The industry is now heavily working to optimize systems that use even more advanced systems for identification, behavior analysis and other forms of situation awareness.

An innovative camera system that could in future enhance security in public areas and buildings is the "Smart Eyes" system that will be shown at Security Essen by the Fraunhofer Institute for Applied Information Technology FIT. The system works just like the human eye and analyzes the video in real time and then immediately flags up salient features and unusual scenes. The Smart Eyes camera may for example record a stand during a soccer match and the software focuses on salient events such as a person on the edge of the pitch. During a match when fans in the stadium are ecstatic, it's hardly surprising that the security personnel fail to spot a brawl going on between a few spectators. Separating jubilant fans from scuffling hooligans is virtually impossible in such a situation. To spot anything untoward and identify anything out of the ordinary in such a situation could provide a solution. The researchers that have developed "Smart Eyes" as part of the EU project "SEARISE" have designed the automatic camera system to replicate human-like capabilities in identifying and processing moving images. Like the human eye, it can, for instance, distinguish objects when observing a scene, even if the objects are moving in front of a very turbulent background. The



Smart Eyes system analyzes the recorded data in real time and immediately points out salient features.

"That is invaluable for video surveillance of public buildings or places", says Dr Martina Kolesnik, research scientist at the FIT. "In certain circumstances the capabilities of a human observer are limited. Ask someone to keep an eye on a certain stand in a football stadium and they are bound to miss many details. That same person can only carefully monitor certain sections of the whole area and will quickly get tired." The system hardware consists of a fixed surveillance camera which covers a certain area, and two ultra-active stereo cameras. At the heart of Smart Eyes is innovative software that automatically analyzes the image sequences. "Our image analysis software is compatible with camera systems produced by all vendors. It can be installed easily."

This system is only one of hundreds of new and established systems that will be presented at Security Essen in October to help security professionals with their daily work. When you attend the show please make sure that you stop by at our stand in Hall 2 Stand 506.

Enjoy reading this issue

[www.GIT-SECURITY.com](http://www.GIT-SECURITY.com)

REGISTER NOW for our  
free NEWSLETTER

## RFID-Technology for Innovative Access Control

### proxMagic®

- **High Flexibility**

One reader for all proximity technologies.



### bioProx®

- **Double Security**

Contactless access control and biometric verification.



### tranSpeed

- **High-Speed Access Control**

Vehicle access and car park management for indoor and outdoor installation.



### proxSafe®

- **Perfect Control**

Secure and electronically recorded management of keys and valuables.



deister   
electronic

deister electronic GmbH  
Hermann-Bahlsen-Str. 11  
D-30890 Barsinghausen  
Tel: +49 (0) 51 05 - 51 61 11  
[www.deister.com](http://www.deister.com)

The RFID Company



**Lasers in Security**  
**The First Laser Scanner Certified with VdS Class C**  
 Protecting persons, securing valuables, preventing (or at least the early detection of) crime, electrical and electronic systems for secure building automation are increasingly gaining in importance. The technological solutions are correspondingly innovative. Matthias Mezger, Manager of Marketing and Sales Building Automation at Sick, takes a look at the developments in the use of lasers for intrusion detection. **30**



Visit us at  
**SECURITY Essen:**  
 Hall 2 · Stand 519

SECTIONS

- News..... 6
- Security Products..... 44, 69
- BUSINESSPARTNER..... 70
- Company Index/  
 Imprint..... Inside Back Cover

**EDITOR'S NOTE**  
**Vigilant Cameras**  
 Heiko Baumgartner **3**

MANAGEMENT



**The GIT SECURITY AWARD 2011**  
 Choose your favourites from each category! **8**



**HOMELAND SECURITY**  
**A Security Checklist**  
 Contemporary Solutions to Growing Security Issues **20**

DISPLAYS



**Built First to Last**  
 A TFT-LCD Display Equipped for a Long, Hard Life **22**

ANNIVERSARY



**Happy Birthday!**  
 Gutebruck Turns 40 **24**



**TRADE SHOW**  
**A Secure Date in November**  
 An Advance Look at the Products and Services at Sicurezza 2010 **26**

FIRE PROTECTION



**Unseen Until Needed**  
 Invisible Fire Protection in the New Acropolis Museum **28**

SECURITY



**VIDEO SECURITY**  
**Mission Accomplished**  
 The Right Camera Solution for Every Video Security Project **32**

SECURITY FOR RETAIL



**Behind the Scenes at Uniqlo**  
 SureVue and Panasonic Step-up in High-profile Retail Location **35**

CCTV



**HDcctv: The Third Way**  
 The Low-cost Path to High-Resolution Surveillance Video **36**



**Short Waves over Long Distances**  
 Innovative Wireless Solutions Bridge Network Gaps **40**





**Back on the Rails**  
 Metro Durban Rail Makes Railway Stations  
 More Secure with Modern CCTV **52**



**Pilot of the Railways**  
 Finnish Rail Chooses IndigoVision for  
 Pilot IP-CCTV Project **55**



**Take a Good Look**  
 Considerations When Planning a  
 Surveillance System **56**



**Virtual Space in EMEA**  
 Bringing Virtualization  
 to Storage Networks **58**



**SECURITY ESSEN**  
 The World of Security and  
 Fire Protection  
 Security Essen Opens Its  
 Doors from October 5 to 8 **42**

**Security Innovations** **43**

**New Series of Megapixel Cameras**  
 Vivotek Launches First Supreme Series  
 Network Camera **43**

**Total Security Solution Capability** **48**

**Security for People, Processes and Assets** **48**

**PERIMETER PROTECTION**



**Right at the Edge**  
 Applying Sensor Cable Perimeter Protection  
 and Intruder Detection Technology **49**



**CAMERA TEST**  
 Test the Best!  
 In Focus: Basler BIP-D1300 **50**

**INTERVIEW**



**Looking Forward to a Highly Defined Future**  
 An Interview with Sanyo's European Sales  
 Manager David Hammond **60**

**ACCESS CONTROL**



**Online Access Control without Wiring**  
 All Authorizations in One ID at Crane  
 Manufacturer Wilbert **62**



**A Different Approach Worth the Effort**  
 Cambridge Innovation Center Upgrades  
 Its Access Control System **64**



**Putting the Face to the Name**  
 Integration of Access Control and  
 Video Surveillance **66**

**LOCKING SYSTEMS**



**Pick the Right Lock**  
 Using Digital Door Furniture for Discrete  
 Access Control **68**

Leading<sup>A</sup>  
 the way in  
**Megapixel**  
 video

**Cutting-Edge  
 Innovations**

**Superior  
 Performance**

**Broadest  
 Selection of  
 Megapixel  
 Cameras**



**Arecont Vision**  
 megapixel technology...  
 beyond imagination

+44 (14) 4085 8054  
 ArecontVision.com

made in the USA

Visit us at  
 SECURITY Essen:  
 Hall 2 · Booth 519

### Boundaries of Security Report's New Edition

The 2011 edition of the Boundaries of Security Report, a global resource for security industry professionals, will be released at the Milipol 2010 Exhibition in Doha, Qatar on October 25<sup>th</sup>. The 89 page report was originally published last year by designers and manufacturers of world leading fiber optic intrusion detection technologies, Future Fibre Technologies. The first edition of Boundaries of Security received exceptional views from security experts including Ian Bergman, Government Liaison Manager at Dyesol, who said the report analyses complex and inter-related issues (technical, policy and human nature) in a very balanced and logical way, reflecting reality rather than hype. "It touches on many subtleties in the area of perimeter protection, identifying strengths and weaknesses of the industries technologies very well in an obviously unbiased way," he said. The new edition has been updated to include the latest market research and emerging industry trends from IMS Research, plus best practice recommendations for infrastructure and high value asset protection. It also features clear explanations of the latest intrusion detection technologies including C-OTDR Fibre Optics, and Ground Based Radar systems. [www.fftsecurity.com/BoS/](http://www.fftsecurity.com/BoS/)



### G4S Wins Police Forensic Medical Services Contract

G4S Forensic and Medical Services, the leading provider of medical and forensic services to the police in England, has been awarded a three-year contract to deliver forensic medical services to five police services, including Essex, Suffolk, Norfolk, Cambridgeshire and Bedfordshire. The contract was awarded following a competitive four-way tender. As part of G4S Integrated Services, which specializes in providing integrated facilities management and specialist support services in critical environments, G4S Forensic and Medical Services will deliver a full range of forensic medical services to detainees and victims of crimes across all five counties within a framework of robust clinical governance. Under the contract the company will deploy around 200 medics and office support staff. [www.g4s.com/uk](http://www.g4s.com/uk)

### Genetec's Rapid Growth Propels New Corporate Initiatives

Genetec announced that its rapid growth and commitment to delivering innovative solutions has led to more global expansion, new product development and the launch of its new corporate image and website. The company decided to refresh its visual identity. Some of the new corporate initiatives paralleled with the new branding include the opening of an office in Singapore, the upcoming launch of new products, and a new corporate website. The new office in Singapore will also accommodate new members of the company's Technical Assistance Center, expanding it's 24/7 support reach to all time zones. The manufacturer's global expansion is a direct response to the growing demand for its security and public safety solutions worldwide. [eknuutila@genetec.com](mailto:eknuutila@genetec.com)



Security, Hall 2, Stand 226

### Norbain Supplies New American Dynamics Hybrid DVR

Norbain has announced the release of the HDVR (hybrid digital video recorder) by American Dynamics, a brand of Tyco Security Products. It protects analogue camera investments while either transitioning to IP cameras is considered, or the benefits of a mixed environment are enjoyed. It also provides seamless integration and recording of both analogue and IP video surveillance cameras on an enterprise class chassis. The powerful, yet easy to operate, client user interface installs on any standard computer running Microsoft Windows XP, Vista or Windows 7 and can connect to multiple servers. Video from all HDVR systems can also be accessed with web browsers, mobile devices or via access to the Internet. Each server supports 16 or 32 analogue inputs and 8 IP inputs, which can be easily expanded to 64 IP cameras per server. [marketing@norbain.com](mailto:marketing@norbain.com)

### Hikvision Hybrid DVRs Integrated with Pelco Network Cameras

Hikvision Digital Technology and Pelco by Schneider Electric, have announced the integration of the DS-9000 series hybrid DVR from Hikvision with a wide range of network cameras from Pelco. The Hikvision 4-channel, 8-channel and 16-channel hybrid DVRs will now support Pelco network cameras, including Sarix Mega-Performance Cameras (IXS0/IMS0/IDS0, IX10/ID10/IM10, IXE20/IDE20 and IX30/ID30 series cameras), Spectra IP Series Dome Positioning Systems (Spectra Mini IP and Spectra IV IP), IP110 Series Camclosure Indoor/Outdoor Network Mini Dome and IP3701 Series Color Network Cameras. "Our collaboration with Hikvision demonstrates the Pelco commitment to be a true Open Systems Provider through our Partner First Program. We are now able to offer flexible, reliable and scalable feature-rich integrated security solutions to our mutual customers," says Stéphane Lantoine, Pelco Business Development Manager EMEA. "We are excited about this integration, as the Hikvision platform gives our customers a new high-performance option for IP recording based on their business size or preference." [wulin@hikvision.com](mailto:wulin@hikvision.com)

### Abu Dhabi DOT Selects March Networks IP Video Solution

March Networks announced that the Abu Dhabi Department of Transport (DOT) in the United Arab Emirates is using the company's Videosphere solution in a new customer care facility to ensure the safety and security of clients and staff, and improve customer service. The solution includes Videosphere Video Management System (VMS) software, Campx Minidomoe IP Cameras and analytics available in the Videosphere portfolio. Responsible for Abu Dhabi's extensive network of road, rail, port and air travel infrastructure, the DOT recently opened the state-of-the-art facility in the Marina Mall to provide permit and licensing services to hundreds of customers daily. Staff are also available to receive transport-related suggestions and complaints from the public. The DOT selected the manufacturer's solution for its exceptional video quality, efficient H.264 compression and system reliability, as well as its support for advanced analytic applications such as left object detection and queue length monitoring. [emaspero@marchnetworks.com](mailto:emaspero@marchnetworks.com)

Security, Hall 7, Stand 320

### Senstar: New Vice-President Product Sales

Senstar Corporation announced the appointment of Gord Loney as Vice President of Product Sales. This new position has been created in order to drive the company's product sales globally as it implements a strategy to rationalize its entire product line, develop new technologies and introduce new products. Loney joined the company in 1995 as the product sales manager for Canada, Africa and the Middle East. He was subsequently promoted to Director of International Sales responsible for Australasia. Prior to joining Senstar, he spent 25 years in the Canadian Air Force as a fighter pilot retiring in the rank of Lieutenant Colonel. He is a staff college graduate and has a degree in Engineering Physics from the Royal Military College of Canada. [cmchugh@senstar.com](mailto:cmchugh@senstar.com)

### Call System

C-Tec's Quantec addressable call system is playing a key role safeguarding staff at a new Child and Adolescent Mental Health Inpatient Unit in Belfast. Specifically constructed to provide Tier 4 and assessment services for young people aged 13 to 18, the new Beechcroft Unit now boasts an extensive range of the company's high quality brushed stainless-steel Quantec call system components. The main building and two extended areas house three powerful Quantec controllers that constantly monitor all network devices and indicate the exact ID number of any faulty devices. A series of stainless steel door monitoring points prevent unauthorized exits from the purpose-built unit. [www.c-tec.co.uk](http://www.c-tec.co.uk)



Security, Hall 1, Stand 501



### Secura Systems: Crime Prevention in Rotterdam-Rijnmond

Secura Systems and the Police of Rotterdam-Rijnmond together have successfully operated two projects for the highly explosive finals between Feyenoord Rotterdam and Ajax Amsterdam. Wireless equipment from Wavesight as well as the SentryScope 21 Megapixel camera have been used. The Police of Rotterdam decided to go with the company due to the immediate availability and the technology used. "Secura Systems worked straightforward and very quickly. They did a great job. It is quite unusual that within two days only a company can install and operate such a complex system. There were more than 10 km of wireless connections throughout the city with a constant bandwidth of approximately 45 Mbps. This combined with the unrivalled technology of the Sentryscope 21 Megapixel cameras we were able to observe the whole scenery in front of the stadium and the city hall at all times with only two cameras. We're talking about 35,000 m<sup>2</sup> each or to stick to soccer, approximately 5 times the size of a football field," notes Cor van Paridon, who was in charge of the project on behalf of the Police Rotterdam-Rijnmond. "To accept challenges and to master them is the base of our daily work. It's great fun to combine different products for projects such as this to generate an efficient solution. The cooperation with the responsible people from the police was excellent and highly professional," stated Paul André de Jong, managing director of Secura Systems. The Police of Rotterdam-Rijnmond leads if it comes to employing new technologies. More than 500 cameras are deployed around in the city and are analyzed in the central monitoring stations. From here the police can also access more than 3,000 cameras installed in public transport. A new feature used during the game Feyenoord vs. Ajax was a lip-reading device to see instantly if people were chanting anti-Semitic paroles or other banned texts. Furthermore all field personnel were provided with live images to their PDAs to quickly pick up troublemakers. paul.dejong@securasystems.de

### Nice Systems and Esri Sign Technology Partnership

Nice Systems and Esri, a leading provider of geographical information system (GIS) software, announced that the companies have entered into an OEM agreement to enhance Nice Situator with Esri's GIS capabilities, for enhanced situation management. Under the OEM agreement, the Esri Arcgis software engine will be embedded and integrated into the Nice Situator solution. The new integrated solution will serve the security operations needs of seaports, airports, public transport, railways, city centers, military organizations, as well as enterprises. The integrated solution combines Nice Situator's data fusion, analysis and automated response capabilities, with Esri's spatial analysis, data management, and Gis mapping, to improve situational awareness and real-time situation management. The Situator correlates data from diverse security, safety and operational systems, alerting operators in real-time to incidents that require attention. All of the relevant information is then overlaid on an intuitive Gis interface, so control center operators can visualize situations in a geographic context, using Situator's pre-programmed response plans to help guide and automate their response. [www.nice.com](http://www.nice.com)

### Viasys Wins Frost & Sullivan Award 2010

Frost & Sullivan is entering its 49<sup>th</sup> year in business with a global research organization of 1,800 analysts and consultants who monitor more than 300 industries and 250,000 companies. The Company's research philosophy originates with the CEO's 360 Degree Perspective, which in turn serves as the foundation of its Team Research methodology. This approach enables the research company to determine how best-in-class companies worldwide manage growth, innovation and leadership. Based on the findings of this Best Practices research, the company presents the 2010 Europe Competitive Strategy Innovation Award in the video analytics market to Viasys Intelligent Video Analytics (Viasys). Advanced capabilities have positioned intelligent video analytics as a technology with tremendous potential within security as well as non-security applications. The Competitive Strategy Innovation Award is a prestigious recognition of Viasys' accomplishments in the video analytics market. [info@viasys-iv.com](mailto:info@viasys-iv.com)



hall 3 | stand 409

## Automatic Fire Detector 420 Series

Intelligent detection. Superior protection.

**Automatic Fire Detector 420 Series by Bosch:** Protection for every requirement. Bosch has extended its range of detectors equipped with Intelligent Signal Processing (ISP) technology, adding three new variants with Dual Ray Technology. The 420 Series now detects fires faster and more accurately than ever, while minimizing false alarms in every environment. The series covers every Test Fire (TF) category of which the FAP-DO 420 variant is a cost-effective solution to detect Test fire TF1, even without the combination of other sensors. For more information visit our website or contact your nearest Bosch representative. [www.boschsecurity.com](http://www.boschsecurity.com)



**BOSCH**  
Invented for life

Ultimate precision with  
**Dual Ray Technology**



Please let us have your votes by 1.11.2010 for category A and by 1.12.2010 for categories B, C, D and E

# Vote for the GIT SECURITY AWARD 2011

Choose one product from each category

Here we go into the new season. The big names and also hitherto unknown companies in the security and safety business have submitted products for the GIT SECURITY AWARD 2011. Out of all the products, the Jury has nominated ten from each of the categories and presents them to you, dear reader, for your vote. You will find the products on the following pages – here now are the most important details about placing your vote.

The regular readers of GIT SECURITY already know the conditions for our awards. New readers should know that it is never easy for the Jury to choose just ten products from the large number of product submissions, from which you should vote for the winners. Products that have not been nominated this time, or rather the companies that have submitted them, are strongly advised to try again next time.

This year's GIT SECURITY AWARD has been publicized both nationally and internationally. So all the German-speaking readers of GIT SICHERHEIT and also those of the international edition GIT SECURITY, throughout the whole of Europe and as far as the Middle East and into Africa, are able to cast their vote.

The Jury with representatives of the BHE, TÜV, VDMA, ZVEI as well as the users has made the nominations, now make your choice on the following pages.

## Who will win?

This reader vote will now decide which of the nominated products will receive the first, second and third prizes in the following categories:

- A – Safe Automation
- B – Fire Protection
- C – CCTV
- D – Intruder Protection + Access Control
- E – Safety at Work + Hazardous Material Management

Now it's your turn! You decide which product in each category should be the winner.

## This is how to vote

**Fax:** Simply copy the fax coupon on page xxx, complete it and fax it to us.

**Internet:** Go to [www.PRO-4-PRO.com/go/GSA2011](http://www.PRO-4-PRO.com/go/GSA2011). There you will find instructions on how you can vote with a click of the mouse. And, of course, how you can call up information on the product highlights using the respective Direct-Code. Further information can be obtained  using the direct links to the companies.

**Ballot papers:** We have some ballot papers ready with which you can also place your vote.

**E-Mail:** Alternatively you can send us an e-mail with the category and your favorite (only one per category) to [GSA2011@gitverlag.com](mailto:GSA2011@gitverlag.com). Please remember to include your complete company address. Private individuals are not entitled to vote; a company address is absolutely essential.

**GIT SECURITY AWARD 2011**  
NOMINEE

GIT VERLAG  
A Wiley Company



You have five votes – one vote for each category.

By submitting your votes, you are automatically taking part in the reader's prize draw.

## Win the reader's prize!

This year we have obtained a really attractive product from the world of digital photography as the reader prize – a digital single lens reflex camera from Pentax. With a little luck, this could soon belong to you. To qualify, make sure you vote in the GIT SECURITY AWARD. Choose just one product from each of the categories A, B, C, D and E and simultaneously take part in the draw for this wonderful camera. This impressive Pentax camera will make you into a snapshot professional; taking photos will be fun and the technical highlights of the camera are all the rage - the experts all think so too. So we would like to say a big "Thank You" to Pentax!



Employees of participating companies may not vote for their company's product. Employees of GIT VERLAG and Wiley are excluded from voting. Legal recourse is excluded.



## The WiseNet1 DSP chipset Benefits as clear as the image captured



**WiseNet1**

Built-in SD  
card slot



Hybrid dual  
Ethernet and  
BNC output

True High  
Definition and  
1.3 Megapixel  
resolutions

ONVIF  
compliance



H.264  
compression

Samsung Super  
Noise Reduction



Intelligent Video  
Analytics (IVA)

NET-i viewing  
software



### Introducing H.264 High Definition Megapixel Cameras featuring the WiseNet1 DSP Chipset

The Samsung iPOLiS range of IP and network products now includes H.264 High Definition (HD) megapixel cameras and domes featuring Samsung's WiseNet1 DSP chipset.

With up to four times the resolution of a traditional analogue camera, they are capable of simultaneous streaming at VGA, SVGA, QVGA, true 720p HD and full 1.3MP resolutions to provide video for a wide range of applications from control room operators to smart phone users.

Offering seamless integration with Samsung's range of standalone network video recorders, NET-i recording software and license-free NET-i viewing software, they are also fully ONVIF compliant and compatible with a range of leading third-party management platforms.

The WiseNet1 chipset brings a host of advanced functionality to your security application, including third generation Samsung Super Noise Reduction for enhanced low-light performance, high level H.264 compression and license-free intelligent video analytics straight from the box. Why not find out for yourself how these benefits are as clear as the image captured?

Surface Mount



Flush Mount

Flat Dome

Vandal  
Resistant

## Category A: Safe Automation

### Georg Schlegel: Self-monitoring Contact Blocks for Emergency Self-monitoring Contact Blocks for Emergency Stops

Even redundant, secure emergency-stop chains are ineffective unless the contact block is accurately connected with the emergency stop button. The patented self-monitoring safety contact blocks

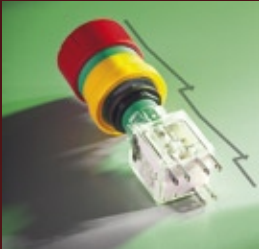

by Schlegel are the response to this danger that may occur e.g. as a result of negligent assembly or mechanical damage. In such a situation the self-monitoring safety contact block acc. to EN60947-5-5 and EN13850 ensures that the emergency function is activated and the installation is switched off immediately. It can only be re-started after successful trouble-shooting.

Further Information at [www.PRO-4-PRO.com/gitsecurityaward](http://www.PRO-4-PRO.com/gitsecurityaward)

Direct Code **8KPB**

### SICK AG: miniTwin Safety Light Grid Safety Light Grid



Until now, innovation steps in the field of safety light grids were rather low. With the revolutionary miniTwin, however, SICK has ushered in a completely new era for light grids. For the first time ever, the sender and receiver are located in a single mini housing unit, so that hazardous points can now be protected

using two identical units. The compact blind-zone-free design and also the smallest protective field heights of 120 mm, increasing in only 60 mm steps enables a previously unattainable level of integration into the machine design as well as completely new protection concepts. With simple, LED-guided start-up and colour LEDs for quick alignment and "double-sided protective field visualization", commissioning is child's play.

Further Information at [www.PRO-4-PRO.com/gitsecurityaward](http://www.PRO-4-PRO.com/gitsecurityaward)

Direct Code **JM8T**

### Baumer: Magres Redundant – Safety Implementation in All Its Ramifications – Redundant Encoders



The redundant singleturn and multiturn sensing system of the Magres redundant is unique and unrivalled in its compact configuration. The integrated monitoring system compares the values provided by the individual position systems and will give an error warning in case of mal-

function. This increases the system safety, unloads the control and reduces cabling efforts. Magres redundant provides top-grade functionality available even in 58 mm versions and providing the characteristic Magres robustness thanks to fully-magnetic sensing without breakable parts and consistent component reduction. The Magres redundant, in combination with a compact cable-pull, allows Baumer to present a special high-light in cost-efficient solutions for length measurement in safety-relevant applications.

Further Information at [www.PRO-4-PRO.com/gitsecurityaward](http://www.PRO-4-PRO.com/gitsecurityaward)

Direct Code **64HX**

### Contrinex: IP 69K Safetinex Safety Light Curtains and Access Control Barriers

The Safetinex safety light curtains and access control barriers from Contrinex now also feature protection degrees IP 65, IP 67 & IP 69K and are thus resistant to industrial cleaning. The IP 69K protection degree is moreover obtained without the conventionally used plastic protection tubes, which results in a considerable reduction of mounting costs. These Swiss quality products correspond to safety category 4 and Performance Level e according to EN ISO 13849-1 as well as type 4 according to IEC 61496-1 and -2. The range comprises models with resolutions of 14 mm (YBB-14) for



finger protection and 30 mm (YBB-30) for hand protection as well as access control barriers (YCA) with 3 to 6 beams and beam gaps of 300, 400 or 500 mm

Further Information at [www.PRO-4-PRO.com/gitsecurityaward](http://www.PRO-4-PRO.com/gitsecurityaward)

Direct Code **EXXS**

### Pepperl + Fuchs: DART Intrinsically Safe Electric Circuits

With Dynamic Arc Recognition and Termination, Pepperl+Fuchs have presented a totally new concept for intrinsically safe electric circuits. It does not prevent the formation of a spark by drastically limiting the maximum effective power, but uses a dynamic electronic circuit, which automatically stops the flow of current, before a spark is able to ignite the atmosphere. Dynamic Arc Recognition and Terminations is based upon a totally new approach to guarantee the intrinsic safety (Ex i) demanded for explosion hazardous areas. With DART the formation of any potentially dangerous spark is turned off before it reaches ignition capability. Doing so DART uses the fact that any



spark is accompanied by a sudden change of the flow of current within the electric circuit which is characterized by a typical pattern. DART detects this effect and reacts within only a few micro seconds by switching off the circuit. DARTS puts an end to the presently known power limitations and will allow the use of intrinsically safe field devices with a power rating of up to 50 watts within the explosion hazardous area.

Further Information at [www.PRO-4-PRO.com/gitsecurityaward](http://www.PRO-4-PRO.com/gitsecurityaward)

Direct Code **2BQ2**

### K.A. Schmersal: AZM 400 Solenoid Interlock with Innovative Features

The Schmersal Group is currently developing a new generation of solenoid interlocks which fundamentally differs from the company's existing interlock range. The electrical drive of the bolt interlock enhances the operating comfort and allows for the integration of the AZM 400's safety functions into the automated production process. The position of the guard door is controlled by a non-contact sensor-target combination which is individually coded and thus protected against manipulation. A new feature of the solenoid interlock is the fact that the

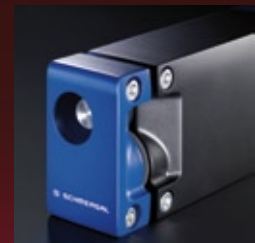

extremely flat target which has the form of a coin can be integrated in the frame of the guard door, thus saving space and making do with just one component that must be mounted and installed.

Further Information at [www.PRO-4-PRO.com/gitsecurityaward](http://www.PRO-4-PRO.com/gitsecurityaward)

Direct Code **5ZJ5**



# intersec

trade fair and conference

**BOOK YOUR  
STAND NOW!**

**The largest and most comprehensive  
exhibition and conference for security  
and safety in the Middle East**

- Commercial Security & Information Security
- Fire & Rescue
- Homeland Security & Policing
- Safety & Health

**January 16 – 18, 2011**

**Dubai International Convention  
and Exhibition Centre, Dubai, UAE**

**Intersec 2010 – once again a big success!**

- Visitor numbers up by 11%
- Exhibitor numbers up by 5%
- Proved again to be the most important  
Safety and Security exhibition in the Middle East

**[www.intersecexpo.com](http://www.intersecexpo.com)**

**REGISTER ONLINE  
NOW AT  
[www.intersecexpo.com](http://www.intersecexpo.com)**

 messe frankfurt

## Category B: Fire Protection

**GIT**  
**SECURITY**  
**AWARD**  
**2011**  
**NOMINEE**

### Prymos: Prymos Fire Extinguisher Spray Fire Extinguisher Spray



Prymos Fire Extinguisher Spray can be an important tool for civil protection. It is easy to handle, just like a hairspray. This spray is available in the models "House & Office", "Kitchen & Catering", "Car & Bike"

and "Universal". E.g. the Prymos Fire Extinguisher Spray model "Universal" is the standard spray to be used at home. It offers the universal solution for initial fires of solids, liquids and fat fires as well as electrical appliances with a voltage of up to 1000 V. This spray is especially suitable for household, caravans and alike at temperatures from -15 °C up to 50 °C. The fire performance is rated as 3A/13B/5F. It has a GS- and a MPA-certificate.

Further Information at [www.PRO-4-PRO.com/gitsecurityaward](http://www.PRO-4-PRO.com/gitsecurityaward)  
**Direct Code** **9YSC**

### Enecsys: Enecsys Micro-inverter Micro-inverter for PV Installations

The Enecsys micro-inverter, installed on the rack at the back of each solar module, offers a unique and excellent value proposition compared to conventional string or central inverters. Benefits include significantly increased energy harvest and lower lifetime cost of solar photovoltaic systems, increased inverter reliability to match the life of solar modules, comprehensive web-based monitoring and a communications system that analyzes and reports the performance of each solar module within the PV array to enable system performance optimization, simplification of PV array design, ease of installation, and improved safety.



A potential single point of failure – the central inverter – is eliminated and dangerous high-voltage DC up to 1000V like in common systems is not produced. The new system lowers the risk for fire brigades significantly.

Further Information at [www.PRO-4-PRO.com/gitsecurityaward](http://www.PRO-4-PRO.com/gitsecurityaward)  
**Direct Code** **RDMT**

### Bosch Security Systems: 420 Series Automatic Fire Detectors Dual Ray Technology for Ultimate Precision in Smoke Detection



Bosch Security Systems is extending its 420 Series of automatic fire detectors with three new variants offering enhanced smoke detection meeting all likely application requirements. The new variants feature Bosch's innovative Dual Ray technology. This makes use of a dual-optical sensor that relies on the scattering of light emitted by two LEDs with different wavelengths to

measure smoke density and particle size. This enables the detectors to provide even more reliable differentiation between smoke particles and other particles. The dual-optical FAP-DO 420 detects test fire TF1 without using a multi sensor detector. Like the original four detectors, the new variants feature Bosch's powerful ISP (Intelligent Signal Processing) technology, through which all sensor signals are pre-processed continually by dedicated internal evaluation electronics, analyzed and linked with each other via a built-in microprocessor. This ensures best-in-class differentiation between real fires and disturbances.

Further Information at [www.PRO-4-PRO.com/gitsecurityaward](http://www.PRO-4-PRO.com/gitsecurityaward)  
**Direct Code** **XC8C**

### Krealux: Luminaire KL10 Luminaire with Seal of Approval



At first view unspectacular: Our luminaire KL10. At second view: The only luminaire which is certificated by the VDE, and which is also al-

lowed to bear the EMC- seal of approval. Easiest handling, utilization of the finest materials and fully automated self-control are only a few of the mentionable attributes. It is robust, restrained, presentable and also functional perfect. Also very important: By the independent seal of approval the operator of a building minimizes the risk of liability.

Further Information at [www.PRO-4-PRO.com/gitsecurityaward](http://www.PRO-4-PRO.com/gitsecurityaward)  
**Direct Code** **A55U**

### Novar by Honeywell: Voice Alarm System Variodyn D1 Networking Fire and Voice Alarm Systems

When networking fire and voice alarm systems in larger building complexes, the safety of the total security system comes to the fore. System reliability is indispensable for complex monitoring due to the high transfer rate of information being transmitted between the individual subsystems. The traditional, costly and time-consuming wir-

ing over contacts and inputs is in this case replaced by a comfortable data interface between the individual disciplines. Both systems are networked over two independent interfaces permanently being monitored. Even in the event of line faults, the total system remains fully operational and thus offers maximum safety.

Further Information at [www.PRO-4-PRO.com/gitsecurityaward](http://www.PRO-4-PRO.com/gitsecurityaward)  
**Direct Code** **PDPW**





**Stöbich Fire Protection: Hidden Shield**  
Hidden Fire protection Closure

Worldwide the first fire protection closure without side guides was invented by Stöbich. The patented system with heat insulation is invisibly integrated in the installation situation. In operating condition the Hidden Shield lays folded and by this hidden in the lintel area of the opening. During an alarm the system closes speed-controlled and without auxiliary energy. The embrasure provides the guiding and makes conventional side guides unnecessary. The system is planned as an insulating system according to EN 13501-2 (> E 120 und EI 60/90) and openings of 8 x 4 m. Target is the official confirmation for previous tests and the development for larger openings. Due to his hidden installation the Hidden Shield offers completely new de-

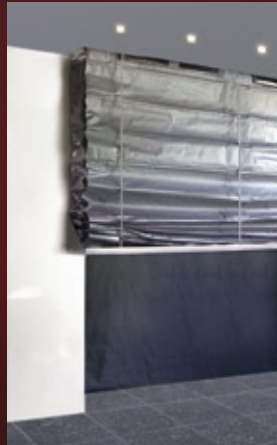

sign possibilities to architects and planers and makes it highly attractive for sophisticated architecture.

Further Information at [www.PRO-4-PRO.com/gitsecurityaward](http://www.PRO-4-PRO.com/gitsecurityaward)

Direct Code **PCUV**

**Securiton: SecuriFire**  
Fire Alarm System

The fire alarm system SecuriFire offers a fully redundant system architecture for the highest system stability. The novel operating technology is intuitive, making use of function keys and the SecuriWheel scroll wheel. All system states are displayed on the 5.7-inch TFT colour screen, uncomplicated by symbols and in plain text. The building of complex, ground-breaking fire alarm networks will be based on the Ethernet. The new SpiderNet-Technology stands for maximum accessibility and not only joins the centres in a circuit but also cross-links them. The result is a high-

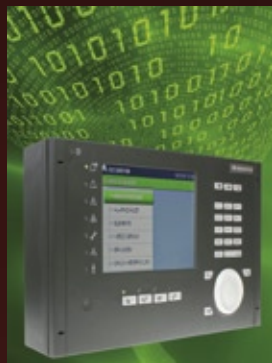

security network resistant even to multiple disruptions. Through SecuriLine eXtended, circuits up to 3,500 metres long and with 250 participants can be created.

Further Information at [www.PRO-4-PRO.com/gitsecurityaward](http://www.PRO-4-PRO.com/gitsecurityaward)

Direct Code **GCSL**

**C-Tec: Extinguisher Panel EP 203**  
Automatic Extinguisher Panel

Fully compliant with EN12094 part 1 and EN54 parts 2 and 4, the EP203 functions as a standard three-zone fire panel with extra circuitry for controlling the release of fire suppressing gas into areas where fires need to be extinguished quickly with minimal damage to equipment. The panel is the first of its kind to feature a

large graphical display with two-colour backlight which makes it very easy-to-install and operate. In addition to being LPCB third-party certified to EN12094-1, the EP203 is also accredited to EN54-2 and EN54-4 and is therefore certifiable under the Construction Products Directive. Ideal for use in remote telecommunication outstations, unmanned chemical plants, computer rooms and any other area containing invaluable equipment, the EP203 epitomises quality, durability and reliability.

Further Information at [www.PRO-4-PRO.com/gitsecurityaward](http://www.PRO-4-PRO.com/gitsecurityaward)

Direct Code **BBRL**



**Hekatron: Ventilation-Smoke-Switch-System LRS 04 Ex**  
Ventilation-Smoke-Switch-System

Protection against fire and not causing a fire – these are the main challenges of fire detection in explosive areas. For this reason only ATEX-approved smoke detectors are allowed to detect fire in explosive areas. The Ventilation-Smoke-Switch-System LRS 04 Ex offers a wide range of applications like the early smoke detection and controlling of ventilation systems as well as fire dumpers and smoke dumpers in explosive areas. LRS 04

Ex is the only system which is AT-EX-approved for the Ex-zones 1 and 2. The system has a fibre glas reinforced body, an optical smoke detector ORS 221 Ex inside, and an intrinsically safe junction box. All components are already pre-assembled on an installation slab to simplify the installation as much as possible.

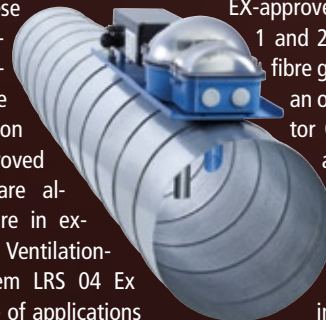

Further Information at [www.PRO-4-PRO.com/gitsecurityaward](http://www.PRO-4-PRO.com/gitsecurityaward)

Direct Code **SHXY**

**FireDos: Mobile Positive Pressure Foam Systems FD-DZ**  
Easy to Upgrade Mobile Positive Pressure Foam Systems

FireDos presents the next generation of mobile positive pressure foam systems FD-DZ. The feature: The new unit works with an admixing rate adjustable in steps of 0.3 %, 0.7 %, 1 %, 2 % and 3 %. Thereby all extinguishing agents

form low surface tension water to foam are possible. The minimum flow is 100 l/min, the maximum flow 1.000 l/min. Under all operation conditions the quality of the foam is equal. Changing flow rates, changing pressure and back pressure or different viscosities do not influence the function of the units. All systems designed by FireDos will be driven by the flow of extinguishing water without any external power.

Further Information at [www.PRO-4-PRO.com/gitsecurityaward](http://www.PRO-4-PRO.com/gitsecurityaward)

Direct Code **WLUU**



## Category C: CCTV

### AG Neovo Technology: SX-Plus Display Series New Generation of Displays

The AG Neovo displays SX-17P and SX-19P work with 5:4 format in smart design of protection glass and metal. The „Advanced Image Platform“ produces full 625 TV-L (PAL) with top black level and



grey scales. 3D-comb filter, deinterlacing and noise reduction like a sensor controlled brightness are optimizing the picture. 2 looping BNC inputs like integrated speaker are showing the versatility. The appliance over touch sensor control keys (with locking) are satisfying like the „Smart Omni Viewer“ with PIP, PAP, freeze and 180° rotation. Classics like „NeoV“-glass and „Anti-Burn-In“ are integrated. The SX-Plus series: Made with safety class IP22 for using 24 hours 7 days a week - all this according to “Green-IT” with very low power consumption.

Further Information at [www.PRO-4-PRO.com/gitsecurityaward](http://www.PRO-4-PRO.com/gitsecurityaward)  
Direct Code **Y279**

### Samsung: SV-5 DSP Chipset Chipset Including Video Analytics Functionalities



Samsung's SV-5 DSP chipset equips an entire range of analogue CCTV cameras and domes with advanced features and functions, such as Intelligent Video Analytics, which would have not have previously been thought possible and at an affordable price. Key features of the SV-5 DSP chipset include: Intelligent Video Analytics including

optical tripwire and enter/exit direction detection as well as an Appear/Disappear function to enable users to take a proactive approach to detecting criminal activity. Superb 650TVL resolution colour images even in the most demanding of lighting conditions such as dazzling sunlight or near total darkness which are enhanced by a new powerful Super HAD (960H) CCD, WDR and SSNR (Samsung Super Noise Reduction) technologies. The Wide Dynamic Range (WDR) technology compensates for backlight problems 160 times more effectively than standard BLC.

Further Information at [www.PRO-4-PRO.com/gitsecurityaward](http://www.PRO-4-PRO.com/gitsecurityaward)  
Direct Code **7B3X**

### SeeTec: SeeTec LPR Module 5.3.4 Licence Plate Recognition Software

The SeeTec LPR Module is a software solution to detect and recognize international number plates automatically. It is fully integrated into the SeeTec 5 VMS module and runs all cameras and video encoders that are supported by the SeeTec basic software. It also provides a wide variety of management features such as an electronic ticket system and a number plate database in which additional configurable information such as company or car type can be added. By using image cropping/multi streaming, several lanes i.e. at a gas station can be covered by one megapixel camera, reducing



the costs for hardware and cabling substantially. The SeeTec LPR Module can be combined with other SeeTec solutions i.e. for the retail or logistics industry.

Further Information at [www.PRO-4-PRO.com/gitsecurityaward](http://www.PRO-4-PRO.com/gitsecurityaward)  
Direct Code **PQGD**

### Pivot3: Pivot3 MiniBank Storage Solution for Cost-Sensitive Applications

The MiniBank handles up to 70 cameras with 4-8TB of RAID storage supporting VMS from over 30 partners. MiniBanks are easily configured to support larger camera counts of up to 48TB of shared SAN storage with VMS failover protection.



It is developed for surveillance projects where virtual servers are included with high-availability shared storage. This eliminates the need for separate physical servers, reducing acquisition and operating costs by up to 40%. The approach also lets users dynami-

cally expand over time without affecting existing infrastructure. Since storage can account for 50 percent of the cost of a video system, the MiniBank is essential for users

that need to maximize budget dollars. This highly scalable, integrated server/storage solution provides users with a guarantee that video is accessible when needed.

Further Information at [www.PRO-4-PRO.com/gitsecurityaward](http://www.PRO-4-PRO.com/gitsecurityaward)  
Direct Code **2K8J**

### Milestone Systems: Milestone XProtect Corporate Premium Software with no Limits

Milestone XProtect Corporate is a powerful, open platform IP video management software. It is designed for large-scale security implementations, supporting an unlimited number of cameras, users and sites. Easy-to-use access clients integrate with interactive multi-layered maps and provide operators with exceptional surveillance overview and control. Built-in support for Smart Wall – Milestone's video wall functionality with drag-



and-drop capabilities and flexible configuration – enables seamless command center control.

Further Information at [www.PRO-4-PRO.com/gitsecurityaward](http://www.PRO-4-PRO.com/gitsecurityaward)  
Direct Code **W157**

**GIT**  
**SECURITY**  
**AWARD**  
**2011**  
**NOMINEE**



**Basler Vision Technologies: IP Camera BIP2-640c-dn High-speed IP Cameras**

Basler launched its new generation of high-speed IP cameras. One of them is the ground-breaking BIP2-640c-dn that uses one of the best available CCD sensors with a 640 x 480 resolution. As a result, the BIP2-640c-dn is extraordinarily light-sensitive. The BIP2-640c-dn is capable of providing 100 fps at full resolution with H.264 and simultaneous MJPEG encoding. This makes the BIP2-640c-dn the fastest IP camera available on the market. With its removable IR-cut filter, this camera is a best-in-class



Further Information at [www.PRO-4-PRO.com/gitsecurityaward](http://www.PRO-4-PRO.com/gitsecurityaward)  
**Direct Code** **BVTL**

solution for day and night applications. Ultra-fast trigger functionality and adjustable flash synchronization make it a perfect fit for applications that require precision and speed.

**Dallmeier electronic: VideoNetBox Versatile Video All-rounder**

Owing to its compact and sophisticated design the VideoNetBox is flexible and can be mounted in almost any location. It forms the core of your video system. Configuration, recording, transmission and evaluation – the VNB offers full functionality within a small housing. Through individual configuration options you get exactly the VideoNetBox you need, one that is perfectly adjusted to your requirements and your network infrastructure (MyVideoNetBox...). Its practical form means that the VNB is also suited for flexible temporary applications, for example at construction sites, for undercover



investigations, in branches etc. The small scale VideoNetBox is based on the proven hardware concept from Dallmeier, which guarantees highest reliability and user-friendliness of the VNB.

Further Information at [www.PRO-4-PRO.com/gitsecurityaward](http://www.PRO-4-PRO.com/gitsecurityaward)  
**Direct Code** **CGJS**

**Axis: Q1910-E Thermal Network Camera – Reliable Detection in Dark and Challenging Outdoor Conditions**

Axis Q1910-E Thermal Network Camera is a perfect complement to any network video system that needs to secure an area 24 hours a day, seven days a week. The cameras use thermal imaging, which allows users to detect people, objects and incidents in complete darkness and difficult conditions. Axis Q1910-E is an out-of-the-box, outdoor-ready model that is designed to withstand harsh weather conditions. Installation is



made easy and cost effective with Power over Ethernet (IEEE 802.3af). Axis Q1910-E camera supports H.264 video compression, which reduces bandwidth usage and storage needs by up to 80 % compared to Motion JPEG. The camera provides multiple, individually configurable video streams in H.264 and Motion JPEG.

Further Information at [www.PRO-4-PRO.com/gitsecurityaward](http://www.PRO-4-PRO.com/gitsecurityaward)  
**Direct Code** **BD4A**

**Panasonic: i-Pro SmartHD Cameras Smart HD Cameras**

The i-Pro SmartHD range consists of 3 dome cameras, 3 box cameras and an encoder. These cameras assist with crime prevention by providing a crystal clear image through an impressive one million pixels. Along with the high definition features, it allows for significantly clearer and more detailed identifications of the intruder, which has been proven by security professionals as a key factor



Further Information at [www.PRO-4-PRO.com/gitsecurityaward](http://www.PRO-4-PRO.com/gitsecurityaward)  
**Direct Code** **FAJM**

in solving a serious crime. The i-Pro SmartHD range supports the face detection technology, enabling criminals to be recognised in a much more efficient manner. The cameras ability to capture 30 frames per second allows for real time recording, ensuring no incriminating evidence is lost.

**EverFocus Electronics: EPN 3600 IP Speed Dome Speed Dome Camera with Intelligent Autotracking Function**

The innovative and high-performing day/night NeVio IP speed dome camera EPN 3600 with 36x optical zoom features H.264/MPEG4/ MJPEG compression with up to 25 fps digital output at 4CIF resolution. With triple-streaming output, EPN 3600 offers simultaneous live monitoring and high resolution recording as well as built-in network



Further Information at [www.PRO-4-PRO.com/gitsecurityaward](http://www.PRO-4-PRO.com/gitsecurityaward)  
**Direct Code** **LLKA**

connectivity. The EPN series is engineered with an intelligent auto-tracking function to detect any progressively moving object and follow it within the speed dome's area of coverage. Auto-tracking also features exclusive masking.

**Axxon: Axxon Smart Pro Professional Open Video Management Software**

Axxon Smart Pro offers a comprehensive, open client/server architected network video management system which has been designed to handle up to 256 video channels distributed across five standard specification workstations. The platform combines user simplicity with the power of sophisticated video content analytics including the facility to set up alerts for



directional movement, noise increase, removed object, facial detection and changed background, all within the standard software license arrangement. Axxon's software also enables easy remote control of all major IP and CCTV fixed and PTZ cameras and can receive alerts from these cameras linked to changes in image stabilisation, focus and glare. Ease of control is aided by offering Touch screen control to those viewing images on monitors which offer this capability.

Further Information at [www.PRO-4-PRO.com/gitsecurityaward](http://www.PRO-4-PRO.com/gitsecurityaward)  
**Direct Code** **AAPC**

## Category D: Access Control + Intruder Alarms

**GIT  
SECURITY  
AWARD  
2011  
NOMINEE**

### Bosch Security Systems: Alarm Platform 5000 Flexible Security System



Due to the modular nature of the system the Modular Alarm Platform 5000 allows easy modification of existing installations over time to suit changing needs. The high flexibility of the system, moreover, allows a combination of internal and external network buses. The internal network bus operates CAN

protocol and connects the control panel with system components. The external IP network bus provides connection to systems located in other buildings. Thanks to the open interfaces, it is possible to integrate the Modular Alarm Platform 5000 into other security and building management systems. Set-up and operation is very easy. The multi-lingual color touch screen display can be configured quickly to fulfill a wide range of operational needs and to tailor it to meet individual user requirements. With its robust housing design and encapsulated electronics, the system offers safe installation even in harsh environments.

Further Information at [www.PRO-4-PRO.com/gitsecurityaward](http://www.PRO-4-PRO.com/gitsecurityaward)

**Direct Code**  **UWVR**

### Interflex: IF 6040 Workflow Consistent Process Optimization in Access Control



As a component of the IF 6040 system, Interflex has developed a multi-level, completely paperless approval workflow for online and offline access control. Employees can now submit an access right request for certain times, doors, areas,

or locations directly from their computers. The new web application arranges and speeds up procedures, increases the productivity, flexibility, and transparency of the assignment of permissions, eliminates the risk of transmission errors, reduces the costs of printing and helps our environment by eliminating the use of paper. Above all, standards are set by the universal applicability in various processes for the verification of information, such as e.g. a data import from a parent system.

Further Information at [www.PRO-4-PRO.com/gitsecurityaward](http://www.PRO-4-PRO.com/gitsecurityaward)

**Direct Code**  **XZY9**

### Siemens Building Technologies: Siveillance Netwatch Integrated Solution Links Physical and IT Security

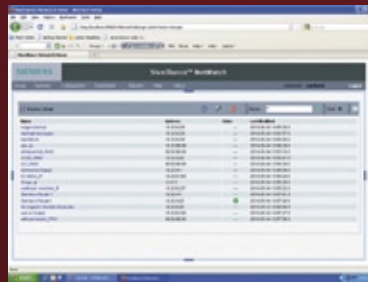

With Siveillance Netwatch Siemens presents an integrated solution which links physical and IT security. The system enables data from security systems – such as intrusion detection, access control and risk

management systems – to be systematically combined with security measures of the IT infrastructure. For example, a PC can be automatically shut down completely if the access control system reports that the owner of the PC is not in the same room. For gathering the required information and monitoring purposes Siveillance Netwatch uses proven Siemens protocols as well as standards such as ICMP and SNMP and specifically developed software agents.

Further Information at [www.PRO-4-PRO.com/gitsecurityaward](http://www.PRO-4-PRO.com/gitsecurityaward)

**Direct Code**  **VRU8**

### ADT: C-Cure 9000 Software House Site Server

C-Cure 9000 is an embedded, hardened field and network-compatible application server for access control systems of up to 32 readers, capable of being easily scaled up on demand. With unsurpassed integration capabilities C-Cure 9000 is suitable for all access control applications with less than 32 readers in any industry. Pre-configured database allows a fast deployment and error-free set-up, the solid state hard drive makes the system extremely robust; the instant-set-up of the system and



the attendance are extremely easy for the user. Next to the complete flexibility and scalability, for the

very first time, enterprise architecture features are available for the price of an entry level system. The Site Server is pre-configured and therefore system vulnerabilities are avoided so that the powerful overall security level is guaranteed.

Further Information at [www.PRO-4-PRO.com/gitsecurityaward](http://www.PRO-4-PRO.com/gitsecurityaward)

**Direct Code**  **GDGS**

### Feig Electronic: Access Control Terminal ID MAX50.10-xE RFID Access Control Terminal for IP-based Networks

ID MAX50.10-xE is an independently-working access control terminal for up to 9000 users with Ethernet interface. It checks access permissions offline, without a live connection to a host system. The integrated real time clock allows the management of temporal restrictions with up to 16 time slots. Events can be stored locally in a configurable event memory. Alternatively, events



can be immediately reported to a host system. Power is supplied via Power over Ethernet (PoE) or via an external DC power supply. The terminal with the design-awarded housing supports passive transponder according to ISO 14443 type A and B, ISO 15693 and communicates with NFC devices.

Further Information at [www.PRO-4-PRO.com/gitsecurityaward](http://www.PRO-4-PRO.com/gitsecurityaward)

**Direct Code**  **RK36**



**Assa Abloy: Cliq-Remote Mobile Locking System Management**



Cliq locking systems are now being extended to include a mobile programming device and a wall programming device which use the newly developed Cliq Remote technology. The hardware enables locking media to be managed au-

tomatically whenever required. Cliq locking system users, for instance, receive changes to their authorisations via the mobile programming device. In the process, data is transferred via USB or Bluetooth on a standard mobile telephone. The internet-based software Cliq Web Manager also assists in managing the Cliq locking system, independently of the time and place. The system administrator can now control the setting and changing of locking authorisations and also assign such tasks to several, mobile users.

Further Information at [www.PRO-4-PRO.com/gitsecurityaward](http://www.PRO-4-PRO.com/gitsecurityaward)  
**Direct Code** **VLTG**

**iCognize: VeinAccess Hand Vein Scanner with Ethernet Connection**

So far sensors of hand vein scanners are connected via USB to an authentication unit. The start-up iCognize GmbH has developed a system, with which the sensor can be connected via Ethernet. As a result longer wire lengths enable

that the authentication unit must not directly be placed close to the sensor, but can be put in a more secure place if needed. A further security aspect is that attacks on IP-level are much better investigated, whereby qualified prevention measures can be taken. An economic advantage is that not every sensor needs its own authentication anymore. Additionally the system fits into a standard cavity wall socket and does not need special assembly solutions. The intelligent LED lighting provides an easy user guidance.

Further Information at [www.PRO-4-PRO.com/gitsecurityaward](http://www.PRO-4-PRO.com/gitsecurityaward)  
**Direct Code** **7CSH**



**S. Siedle & Söhne: Siedle Scope Mobile Video Call Station and Telephone in One**

The cordless alternative: Siedle Scope is a mobile video call station and DECT telephone in one. Scope shows who is at the door – from anywhere in the house, on the terrace or in the garden. With the whole range of functions provided by a video call station for the Siedle In-Home bus, inclusive of hands-free function and door release button. At the same time, Siedle Scope

is a fully functional cordless public network telephone with a whole range of convenience features. The ideal complement to a fixed call station and the ideal retrofit unit for existing video systems.

Further Information at [www.PRO-4-PRO.com/gitsecurityaward](http://www.PRO-4-PRO.com/gitsecurityaward)  
**Direct Code** **NFUH**

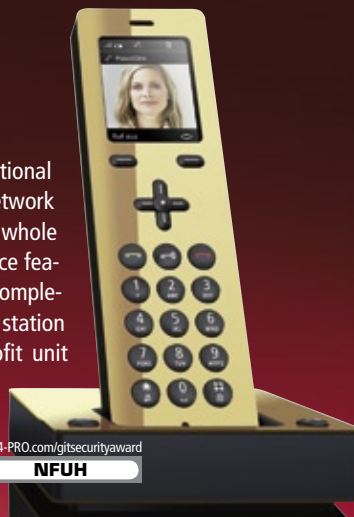

**SimonsVoss: SmartHandle 3062 Digital Locking and Access Control System**

A new innovation has been added to the digital locking and access control system 3060. The new door fitting SmartHandle 3062 combines intelligent access control functions with its elegant, ergonomic design. Classic door fittings require holes to be drilled in doors for fastening. The unique highlight of the SmartHandle is that it can be fastened in the PZ hole already present in DIN locks with a single screw. This so-called "snap-in" procedure ensures that the fitting is permanently secure and takes into account all possible applications of force. Because no wiring or holes are required, the doors remain undamaged. You can



therefore remove the fitting, for example when moving property without leaving any residue and without any damage.

Further Information at [www.PRO-4-PRO.com/gitsecurityaward](http://www.PRO-4-PRO.com/gitsecurityaward)  
**Direct Code** **CQ89**

**UTC Fire & Security: NX-10 Wireless Security System Wireless Security System**

The NX-10 full wireless security system provides 4 partitions and 48 zones. Expanding capability with I/O modules and proximity readers

is fast and easy. The keypad is battery powered and operates bidirectional. All relevant information are also in the "sleep mode" instantly visible. The perfect designed display with two line characters and illuminated background can always be taken off from the wall and provides shortcut-buttons for medical and emergency calls. Extensions with I/O-modules can easily fixed from top on the circuit board. Two antennas are controlled by a microprocessor for best signal. For communication with a monitoring station the NX-10 is also with GSM/GPRS module available.

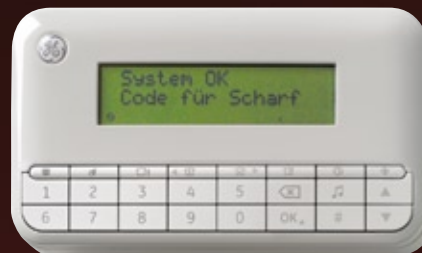

Further Information at [www.PRO-4-PRO.com/gitsecurityaward](http://www.PRO-4-PRO.com/gitsecurityaward)  
**Direct Code** **Q7HK**

## Category E: Industrial Safety

### Capital Safety Group: Mobi-Lok Vacuum Anchor Vacuum Anchor Goes Lightweight

The Mobi-Lok is nearly 40 % lighter than previous generations of vacuum anchors, weighing in at less than 9.5 kg, yet it retains its fall arrest



rating across the globe. This self-contained vacuum anchor provides a portable, non-penetrating personal fall arrest system anchor for use on smooth surfaces. The Mobi-Lok is easy to set up and use. The one-

piece design allows the unit to be placed on a surface and provide an instant, single anchor point through use of the on-board compressed air bottle, without the need for hoses or connections. A unit that can be used with shop air is available. The pads of the anchor conform to a radius of 76cm or more, preventing the need for multiple pad options. It may also be used in tandem with a secondary pad and set up for

a two-person horizontal lifeline system. Additional safety features include a back-up audible alarm, visual gauge and check valves.

Further Information at [www.PRO-4-PRO.com/gitsecurityaward](http://www.PRO-4-PRO.com/gitsecurityaward)

Direct Code **XGTE**

### Draeger: CPS 7900 Second Skin for Tough Assignments

Draeger has developed and produced chemical protection suits for over 50 years. These years of experience are evidenced by the new gas-tight Draeger CPS 7900, which easily meets international standards. The



reusable suit is resistant to flames, chemicals, warfare agents, and liquefied gasses. In addition, it displays high mechanical resistance and can be used in potentially explosive atmospheres. For assignments under extreme conditions, the new gas-tight Draeger CPS 7900 offers higher protection. Its new suit material, D-mex, enables a special resistance to a wide variety of toxic substances and offers comprehensive protection from chemical effects, liquefied gasses, and bursts of flames.

Further Information at [www.PRO-4-PRO.com/gitsecurityaward](http://www.PRO-4-PRO.com/gitsecurityaward)

Direct Code **Q96G**

### Engineering Office Rosin: Emergency-Manager Alpha Emergency Manager

The Emergency-Manager Alpha is able to broadcast fast, simple and precisely acoustic information by use of each sound- / voice alarm system in case of crisis situation (crazed action, fire, gas etc.) in schools

or public buildings. Alpha stands for the new developed "Alarm via mobile" function. Up to 4 different signals or texts for different situations of danger will be stored first and individual in the device and



then can be remote started by each telephone (mobile). So Staff (e.g. teacher), fire brigade or police will have the opportunity to control appropriate steps pointedly, fast and uncomplicated all the time, without leaving their safe location or to enter the building.

Further Information at [www.PRO-4-PRO.com/gitsecurityaward](http://www.PRO-4-PRO.com/gitsecurityaward)

Direct Code **U9NP**

### Kötter Security: Kötter Security ID-Card Tiny Card Provides Fast Emergency Aid

The Kötter Security ID-Card providing emergency call offers in combination with the emergency and service control centre specific help for the group of people who are at risk by attack and accident. This group includes employees in commerce and logistics, especially operating alone at their place of work in the evening as well as employees in banks, pharmacies and gas stations. People adopting activities with risk of overturn (e.g. roofer) will profit as well. The person bearing the ID card cannot be recognized as signal transmitter.

By means of pushing the button or breaking the carrying strap away

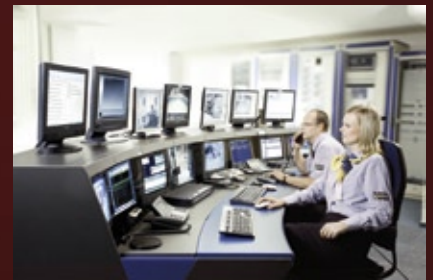

alarm will be released. The emergency and service control centre can be contacted by one-way voice communication. Otherwise the position will be localized by GPS.

Further Information at [www.PRO-4-PRO.com/gitsecurityaward](http://www.PRO-4-PRO.com/gitsecurityaward)

Direct Code **UF62**

### Zweibrüder Optoelectronics: LED Lenser M7 Intelligent Light

The LED Lenser M7 is equipped with light intelligence managed by programmable microcontrollers. These are the core piece of Smart Light Technology (SLT). SLT is an electronic light control system that provides several light programs (Professional, Easy, Defense) and different light functions (Morse, Boost, Power, Low Power,

Dim, Blink, S.O.S, Defence Strobe). The M7 also features stageless dimming. The selection of functions is intuitive and carried out by using only one push-button. SLT not only controls the light programs, but also the manner of discharge of the lamp. There's a choice between steadily decreasing or constant current drain and brightness. And for the first time, the continuously adjustable Advanced Focus System can be locked – thanks to our new Fast-Lock-mechanism.



Further Information at [www.PRO-4-PRO.com/gitsecurityaward](http://www.PRO-4-PRO.com/gitsecurityaward)

Direct Code **TXJF**

**GIT**  
**SECURITY**  
**AWARD**  
**2011**  
**NOMINEE**



### Duran Group: Duran pressure plus The Safer Laboratory Bottle

The Duran pressure plus bottle is always first choice when it comes to pressure and vacuum applications. Thanks to a special geometry (based on ISO 4796-1) in the bottom and shoulder area as well as increased wall thickness, vacuum and pressure resistance of -1 to +1.5 bar is guaranteed. The safety of the Duran pressure plus bottle is certified to DIN ISO 1595 by TÜV and confirmed by the GS marking.



Consequently the bottle provides optimum safety both for user and content. The Duran Group has a comprehensive data package available, intended primarily for the company safety officer, which can be requested under [info.duran@durangroup.com](mailto:info.duran@durangroup.com). It describes the safe handling of laboratory glassware.

Further Information at [www.PRO-4-PRO.com/gitsecurityaward](http://www.PRO-4-PRO.com/gitsecurityaward)  
**Direct Code** **CDXP**

### SpanSet: SpanSet Gotcha Rescue Kit



The SpanSet Gotcha rescue device in accordance with EN 1491 enables a rapid rescue by descent or ascent. It is equipped with pulley tackle

controlled by a rope brake. Equally, pulling up the casualty to a higher point can be carried out quickly and safely. One of the special features of the Gotcha rescue devices is the telescopic pole. This makes it possible for the rescuer to tie the suspended person via a snap-fit coupling to the Gotcha system without the rescuer himself having to get into a dangerous situation. Rescue from a fall-arrest device is possible with the aid of an additional device; please ask us for details. Depending on the circumstances, the system can be attached to anchor points below or above the rescuer.

Further Information at [www.PRO-4-PRO.com/gitsecurityaward](http://www.PRO-4-PRO.com/gitsecurityaward)  
**Direct Code** **36XT**

### Uvex: Sil-wear 3 B Vibatec With Silver to Protect Against Viruses and Bacteria



Uvex sil-Wear provides active protection against viruses and bacteria. The unique AgPure nanosilver coating offers active defence against dangerous microorganisms. The innovative AgPure active

layer provides an optimum level of safety against biological hazards, achieving the highest performance class in accordance with the requirements of EN 14126. It reduces the growth of existing microorganisms by nearly 100% (DIN EN ISO 20743:2007-10). The system for attaching the mask for optimum face coverage is patent pending in Germany. The ergonomic cut and the exclusively developed soft and quiet material offers more advantages.

Further Information at [www.PRO-4-PRO.com/gitsecurityaward](http://www.PRO-4-PRO.com/gitsecurityaward)  
**Direct Code** **CFCA**

### Compur Monitors: Stattox 505 Gas Detector Complies with Sil Standard

Easy handling contributes to safety! The smart sensors of Stattox 505 have an integrated memory holding all relevant data. This makes Stattox 505 a plug – and play sys-

tem. Thus badly accessible sensors can be easily calibrated in the comfort of a workshop, and are then just plugged back in. Display and controls are well protected from the elements. An intuitive menu guides the user when programming parameters. Functional Safety: Stattox 505 fully complies with SIL standard according to the requirements of DIN EN 61508 respectively the product standard for gas detectors DIN EN 50402.

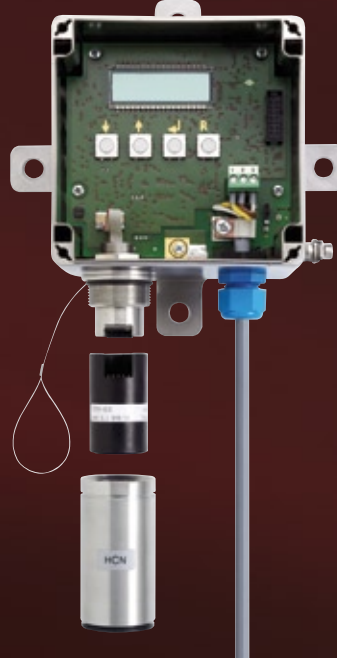

Further Information at [www.PRO-4-PRO.com/gitsecurityaward](http://www.PRO-4-PRO.com/gitsecurityaward)  
**Direct Code** **T5PH**

### Bosch Security Systems: Sound System Line Array Active Sound Technology

The active line arrays combine unmatched sound quality with an evenly distributed sound pattern that covers ranges up to 50 meters. In places such as railway stations, airports and places of worship, hard construction materials are often used which absorb very little sound, creating a reverberant environment. The new vari-directional array from Bosch overcomes this challenge, delivering unmatched acoustical performance in these difficult environments. A key feature of the array is its digitally-controlled directivity, which ensures that sound is sent only where it's needed to produce an optimal sound field with perfect speech intelligibility. The system's electrical beam steering optimizes audience coverage without wasting output

energy on ceilings or empty space above the audience.

Further Information at [www.PRO-4-PRO.com/gitsecurityaward](http://www.PRO-4-PRO.com/gitsecurityaward)  
**Direct Code** **EVZ9**



## HOMELAND SECURITY

# A Security Checklist

Contemporary Solutions to Growing Security Issues



*"My Home is my Castle"*

**Europe seems for the most part to be a blissful island of peace and harmony. Paying continuous attention to personal safety is not an issue for most of the European Union's 830 million inhabitants. But for how long will this situation prevail? It is thanks to the efforts of all the various security forces that things are so peaceful. Working away in the background, we don't notice the high-tech equipment that is being used to maintain this situation. This article turns our attention to some of the techniques and technology used to nip crime and terrorist threats in the bud.**

Internal security is a contemporary subject to which the man in the street gives no special importance. Why would he when he can see no threat? It's a completely different situation in countries such as South Africa where private houses or hotels often resemble a small fortress. But a glance across the Atlantic gives cause for concern. Whole residential areas are fenced in and the access roads patrolled by security guards. Until now, it was only a question of how long it's going to be before that way of life becomes commonplace here too.

But when you take a closer look, you can see many countries – in particular outside Europe – where security plays a much more dominant role than it does here today. And because the threat is not perceived in our community, the readiness to invest in internal security or to accept compromises for personal safety is only very limited. This unfortunately does not mean, however, that security in Europe is a matter of course. If we want to ensure this security in the long term, we have no alternative but to do something about it.

## Measures to Maintain and to Restore Security

There are two approaches to increasing security: on the one hand, to make the vulnerable 'Achilles heel' more difficult to reach; on the other hand to obtain information in good time through intensive observation, which enables successful defense against a threat. Thirdly, the

resources that are called upon when a disrupted environment has to be restored to a secure situation must be considered. The cause of the disturbance is immaterial: whether it was a terror attack or a natural catastrophe – in every case, basic supplies to the general public must be reinstated as quickly as possible.

## Secure Communication

In the era of Twitter and Facebook – to name just two of the forums in the today's Internet – the handling of valuable information that should be protected is becoming even more difficult. This is not least because of the careless attitude of the media that quickly forgets potential danger. Central directions are called for here in government agencies and companies that 'enforce' secure communication – for example using products from the Snapshield family. Nothing changes for the user in his normal behavior – but the background technology ensures that your information is encrypted before transmission and telephone calls cannot be followed. Both analog telephones and ISDN systems are supported, also Bluetooth mobiles or Blackberys and iPhones.

The decision to adopt TETRA after a nurturing phase of over ten years has given the emergency and rescue services a universal digital communications system that is capable of speech encryption, has been introduced in the first towns during 2010 and will be generally available by





Sensors deliver data; the software presents the information in a visual form

2012 – some speak of 2014. Unfortunately, this process, which began in 1996, has not only taken a long time but has remained with very old technology that today is neither ‚state-of-the-art‘ nor does it allow wideband data transmission. This means that the rapid transfer of situation images, videos of an accident location or the quick transmission of a phantom photo to a police car, to mention just a few applications, remain a dream. However, Telefunken Racoms can help here with various broadband ‚add-on‘ solutions that permit development from a simple emergency services network to a powerful ad hoc network.

**Protection of Critical Infrastructure**

Whether a harbor or a nuclear power station, what they both have in common is that the availability of these resources is extremely important for our community. Apart from camera systems and sensors in fences, the compound can also be monitored for vibration. The seismic sensors developed for this task are connected to one another by radio. The battery life lies somewhere between five and ten years so that these systems are considered very easy to maintain. A system is available under the name ‚SAND‘ (Smart All-Terrain Networked Detectors) that detects vibrations and reports them to a central point that displays the alarms on a map.

**Information from the Air – Have an Overview All the Time**

The floods highlighted the situation, the international church congress also showed the gaps just as the European football championship did: often nobody had an overview of the situation! Operating helicopters is expensive, their con-



Static but highly mobile – Telestat



A ship at 8 km distance – in total darkness

stant availability is not guaranteed; the use of drones is only allowed in controlled airspace – and already the dilemma in which we regularly find ourselves during planned as well as short-notice events is clear. Here the TELESTAT can provide a solution. It is a system – part balloon, part kite – that is quickly available, with simple operator approval and low costs. Depending upon the area of application, the system can be fitted with various types of camera that transmit real-time video or high definition images to the ground station.

**Turning Night into Day – See but Don't Be Seen**

Although heat-sensitive cameras were once the tool of choice to be able to gain information at night in total darkness, this technology has its limits. On the one hand – as the name suggests – only sources of heat can be shown. Every other detail (writing, number plates, people behind glass, for example sitting in a car) remained out of sight – but not however when LIGHT technology is used. Where the coastguard is on duty, objects can be identified at up to eight kilometers distance. This novel laser-supported system

doesn't only have excellent optics; the built-in electronic stabilizer guarantees a stable image and the functional principle also permits vision through fog, rain, snow or smoke, without affecting the image of the observed object.

The mobile version can be used up to a distance of 500 meters. As the same technology is used, the system's characteristics are also the same: no blurring from heat sources in front of the observed objects, viewing through glass (window panes, car windscreens, cockpit canopies), no disturbance through rain, snow, fog or smoke.

**Training for the Emergency**

Luckily emergencies caused by natural catastrophes or terrorist activity are rare today. And the question of training and education goes along with this line of thinking. What must be done and when? Will the team leaders make the right decision at the right moment? Do things happen in practice just as they were imagined in theory? Answers to these questions can be provided by the HLS<sup>2</sup> Training Center - a Homeland Security Simulation for the training of crisis managers. With the help of realistic scenarios, the events are simulated in real time, the reactions of the decision-makers recorded and analyzed afterwards so that the next emergency situation doesn't catch us by surprise and swamp us.

Security, Hall 7, Stand 325



200 m distance – in total darkness

**▶ CONTACT**

Telefunken Radio Communication Systems GmbH & Co.KG, Ulm, Germany  
 Tel.: +49 731 1553 0 · Fax: +49 731 1553 112  
 HLS@tfk-racoms.com · www.tfk-racoms.com

## DISPLAYS

# Built First to Last

## A TFT-LCD Display Equipped for a Long, Hard Life

**Eyevis has introduced numerous features to prevent so-called 'image sticking' effects which are likely to occur on LCD monitors when static content is displayed over prolonged time. This is reminiscent of the 'image burn' problem that cathode ray tube monitors suffered from when a static image displayed over long periods of time would literally burn itself onto the inside of the tube and still be visible long after the image had changed or even after the monitor had been turned off.**

The new eyevis Eye LCD4200-24NB TFT LCD-based monitors come with a screen diagonal of 42" and provide high image quality, high resolution, narrow bezels and unique operability in 24/7 applications. Thanks to ultra-thin and slim cases and the narrow bezel, the displays are a first choice for modular video wall applications – the gap between the image contents of adjacent screens is only 30 mm. Whether you want to display video signals or computer signals, any kind of data can be displayed on this new monitor. In combination with the eyevis netpix controller and the eyecon software, a medium for information presentation can be created that perfectly fits smaller control rooms in which space is the main criteria.



### Roll with the Changes

These displays are also the ideal medium to present a company's message. Eyevis provides all the accessories required for wall and ceiling installations as well as customized supports and mobile stands. Special casings are also available to protect against vandalism and adverse operating conditions. This new monitor includes some special features that cope with the ever-changing environment in which they can be expected to operate. The 'detail expansion' feature optimizes the display of very small details, particularly in dark areas. Even the smallest details that would not be visible on conventional monitors can be displayed, generating an extremely brilliant and high-contrast image. True movie mode is a special high-quality display mode for video signals such as those from DVDs up to HD in 1080i (e.g. Blue-Ray).

### Keeping Its Cool

Every electronic device generates heat and TFT displays are no exception. The optimized cooling concept makes use of an open and a closed cooling loop, making it very energy efficient, maintenance-free and economic to run. A special

sealing method avoids dust accumulation inside the display. Dynamic contrast control is an innovative technique that continuously corrects the backlight brightness and contrast of the TFT cells, resulting in a natural, very high-contrast image and reduced power consumption. In general, TFT panels are subject to different ageing processes, depending on how they are used from day to day. This can require countermeasures to minimize the early appearance of negative effects such as an uneven picture, image sticking or a boundary line. Special software functions help to counteract the negative effects of continuous display of static images and 24/7 operation.

### Non-stick

Dynamic pixel refreshing drives the TFT cells so as to avoid image sticking while considerably increasing display lifetime. Pixel shifting continuously moves the entire image slightly in different directions to prevent image sticking. This is almost invisible at normal viewing distance and the shifting area can be adjusted manually if required by the application. Intelligent noise reduction algorithms suppress the noise typically found in analog signals and optimize image performance.

A soft picture mode applies an intelligent scaling mechanism which smoothes out extreme contrast transitions. This avoids boundary line image sticking occurring at sharp transitions (e.g. from black to white). The degree of softening can be adjusted manually if required. An active temperature control system monitors the internal heat level and controls the ventilation fans according to demand.

Security, Hall 1, Stand 405

### ▶ CONTACT

eyevis BUSINESSPARTNER

eyevis GmbH, Reutlingen, Germany  
Tel.: +49 7121 433030 · Fax: +49 7121 4330322  
info@eyevis.de · www.eyevis.de





**Panasonic**  
ideas for life



**FACE DETECTION**

**HD QUALITY**

**LOWER NETWORK  
BANDWIDTH  
CONSUMPTION WITH  
H.264**

**REDUCED POWER  
CONSUMPTION USING  
LATEST MEGAPIXEL MOS  
SENSOR**

***i-PRO***  
***SmartHD***

**SAVINGS BECOME CLEAR  
WITH *i-Pro SmartHD***

The new SmartHD IP cameras from Panasonic combine sophisticated features with lower power consumption and Hi-Definition imaging.

With smart use of network resources and crystal clear images, i-Pro SmartHD brings more powerful tools in the fight against crime ensuring that every detail is captured, day or night.

Panasonic's Eco Ideas initiative enables the reduction of power consumption by up to 45%.

The cameras use face detection technology alongside Panasonic's award winning Super Dynamic technology to ensure backlight is adjusted, giving the clearest view of the subject.

**EVERYTHING MATTERS**



WW-SF332/335/336



WW-SP302/305/306

[www.panasonic.co.uk/cctv](http://www.panasonic.co.uk/cctv)

**eco  
ideas**

***i-PRO***

ANNIVERSARY

# Happy Birthday!

## Geutebrück Turns 40

**There is good reason to celebrate the 40th anniversary of the founding of Geutebrück, the German video security system producer. The company has grown literally from a garage business into a major international player in the security world. A look at the company's philosophy highlights why it has been so successful and paves the way forward to the next anniversary.**

40 years ago this year, Geutebrück began life in a garage on the bank of the River Rhine. Thomas Geutebrück set up a mail order business selling Japanese car radios and hi-fi amplifiers. One day he had a visit from two gentlemen from the German criminal investigation department. It was the era of the Baader Meinhof Group and the Red Army Faction and bank robberies were on the up, so they were looking for some means of taking photographs to identify culprits. There was clearly a ready market; contemporary video recorders were simply not up to the job, so Thomas decided to design a special film camera for the purpose. His camera was unconventional. It was much simpler to make and cheaper to buy and to use than anything produced by trained photographic camera developers. It transported the film with rubber rollers, so perforations weren't needed and less film was required. The camera was a run-away success and came to dominate the market, not just in Germany but right round the world with updated versions of it in production until 2005.

Fortunately for many of the high security sites, prestigious buildings and important organisations across Europe and round the world which are now protected by Geutebrück video security systems, Thomas Geutebrück did not rest on his laurels. His garage-based enterprise flourished and grew, first into a CCTV manufacturer with a strong emphasis on R&D and innovation, then into a digital video security company with an international reputation for quality. Now under the direction of his daughter Katharina, it has developed its IT skills to levels normally only achieved by the top IT specialists;

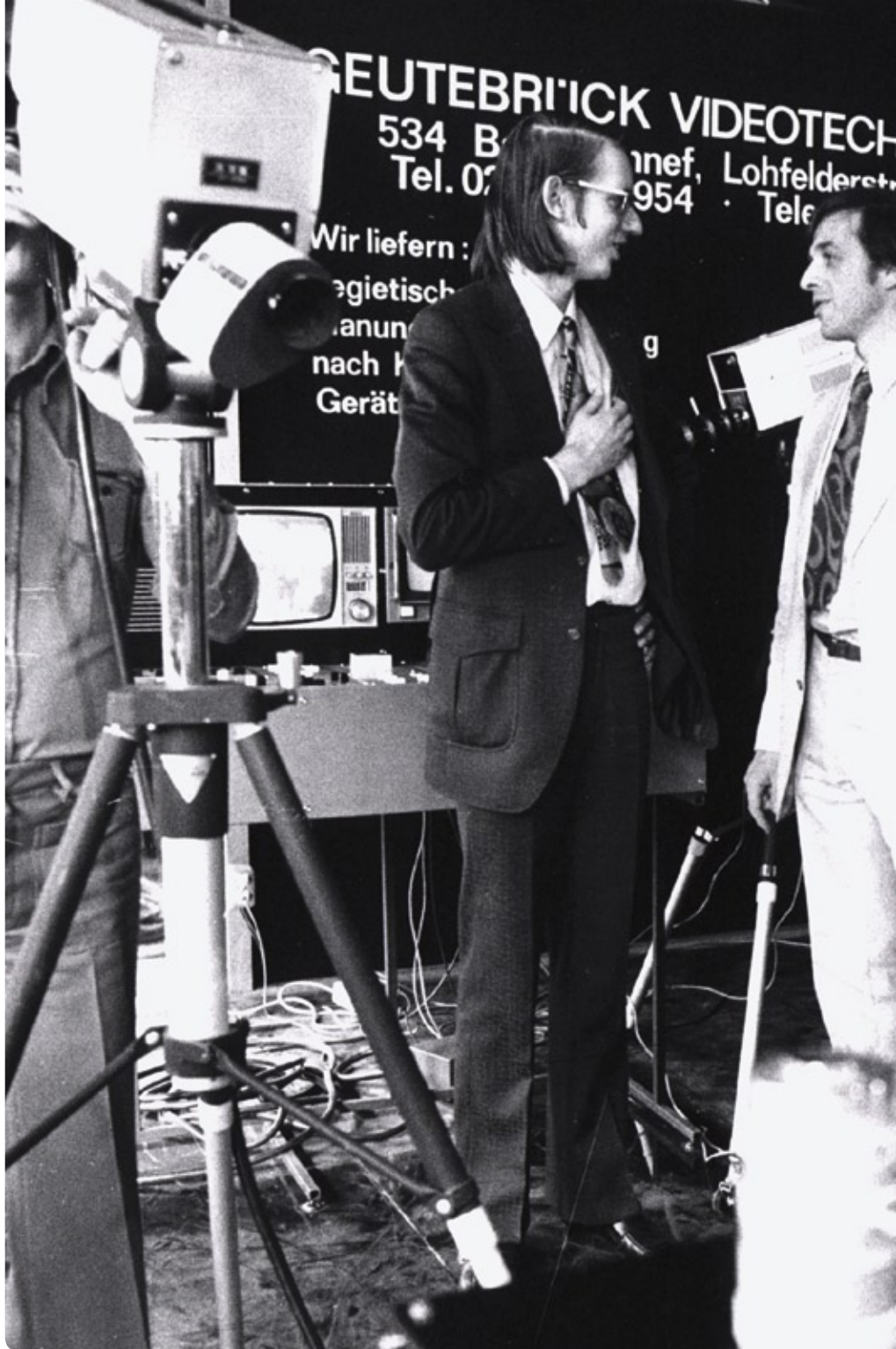

it boasts a 35 million Euro annual turnover and sales partners in 40 countries.

Katharina Geutebrück, daughter of the company's founder and present managing director, thinks this 40th anniversary is not just a good excuse for a celebration but also carries with it a

relevant message for today's prospective security buyers. "In a fast-moving world," she contends, "continuity and stability are important factors in building trust. And with the complexity of today's technology, pure feature-plus-function-based decisions become more and more difficult for users





knowledgeable users who have had experience with other manufacturers with product strategies based on high volume and short-term gain."

**What Are the Secrets of Geutebrück's Success?**

There are at least two key factors which have worked greatly to Geutebrück's advantage over the years. The first is its product philosophy of compatibility, openness and integration. All Geutebrück systems are fully compatible with each other, and in contrast to many of its competitors, the company provides free software development kits which allow for an open interface policy and the integration of different types of system. This provides significant added value for the user, and that, in the long run is good for Geutebrück too.

The second of its secrets is the single-minded pursuit of solutions which meet customers' needs. When Katharina Geutebrück says provocatively with tongue in cheek, that the company's customers don't necessarily get what they want, they get what they need, she is not being arrogant, but rather acknowledging both the high priority given to understanding the user's needs, and the company's free-thinking nature. It is an admission that when the company's high levels of technical expertise are applied to detailed user needs, sometimes the resulting optimal technical solution is not quite what the customer might expect. A factor here being that Geutebrück is not given to blindly following the latest technical fashion in the market. Its financial independence leaves it free to question each new trend for technical benefits and sustainability, and free to exercise its professional judgement. – H.264 for instance is a case in point.

Despite the apparent popularity of H.264, Geutebrück has stuck with its own CCTV-oriented compression format called MPEG4CCTV. Lack of CCTV awareness and inherent drawbacks have been cited as reasons for the company's rejection of H.264 in its basic standard. "We want to offer our customers something better," explains Katharina Geutebrück. "So we are producing our own encoding format called H.264 CCTV combining the advantages of high compression factors and CCTV-aware functionality, low latencies, high operational convenience, precise event management etc. And with the new multi-standard operating software we've developed customers won't be tied to one particular format, they'll be able to choose the best encoding for each project requirement – even down to event-controlled selection of the compression format during recording. But that's something to look out for at 'Security' in Essen!"

to make, so trust has an increasing part to play. Finding a partner you can trust to provide a solution that fits, and that will adapt and still perform after years of use is increasingly important."

"From our 40 years in the business," she continues, "we hope customers will see that we are

a company which builds long term relationships and is here for the duration. We invest a great deal in backwards compatibility to allow our users to benefit from future developments even years after their original investment decision. This is one of our strengths, and it is a persuasive factor for



Security, Hall 2, Stand 409

**▶ CONTACT**

Geutebrück GmbH, Windhagen, Germany  
 Tel.: +49 2645 137 0 · Fax: +49 2645 137 999  
 carmen.lahr@geutebrueck.com  
 www.geutebrueck.com



## TRADE SHOW

# A Secure Date in November

## An Advance Look at the Products and Services at Sicurezza 2010

**Sicurezza is the international safety and security trade show that will be held in Milan, Italy in halls 1, 2 and 4 at the Fieramilano Rho from 17 to 19 November (new dates). The exhibition complex is conveniently close to the metro and railways stations and the trade show is open on each of the three days from 09:30 until 18:00.**

Sicurezza, now in its 15<sup>th</sup> edition, is "the" unique international exhibition in Italy for the security industry. The term 'security' of course now covers a broad range of disciplines, technologies and skills. Therefore a number of sub-headings are necessary to bring some order into the long list of products and services that will be promoted there.

A growing section of interest covers integrated and intelligent buildings. Here we can expect to find environmental products such as blinds and shutters, climate, lighting and utility control as well as sound diffusion. But the integration of these into security systems is of growing interest and there are certain to be some novel ideas available to study.

Certainly the largest section is entitled anti-intrusion and burglary systems. This will cover the fields of CCTV with all its support and ancillary components, indoor and outdoor perimeter protection, all sorts of intruder detection methods, vehicle control and management, central alarm transmission and control as well as the

use of satellites for security purposes. Either careful visit planning in advance or three full days at the trade show will be necessary to do justice to the wide variety of solutions that will be presented here.

The transport and storage of money and valuables demands a section of its own and this contains armored rooms, special vehicles, armor-clad counters and various storage units. It extends also to the protective equipment those personnel on the move need in order to ensure their safety, such as bullet-proof vests and helmets as well as special communications devices.

Of course, if we can prevent crime before it happens, so much the better. For this, the manufacturers of detection and inspection equipment within the intelligence and counter-terrorism section will be demonstrating the effectiveness their products. Explosives, weapons and drugs will be discovered and industrial or political espionage bugs ruthlessly exposed.

The subject of fire prevention will include all flavours of smoke, flame and heat detectors as well as the control systems that analyze and transmit the alarms. The equipment available to extinguish a fire that has already started as well as products and materials for firefighters will take up a significant portion of the total exhibition space. Safety evacuation signs, fire resistant cabling and emergency lighting will also be found here.

The most prominent sector associations will take an active part in building and promoting Sicurezza 2010, and it will also have a new prestigious partner: the UNICRI (United Nations Interregional Crime and Justice Research Institute),



in charge of applied research in crime and the field of justice. With the collaboration of such an important institute, Fiera Milano Rassegne will organize a forum on relevant and topical subjects such as major events security and energy network urban security.

Every afternoon at Sicurezza 2010 a series of one-to-one meetings will be organized where delegates from the Public Sector and other end-users will be called for a face-to-face discussion with the exhibiting companies. This year in particular, the organizers are addressing the security managers of important venues such as shopping centers and museums.

Important opportunities will also be available for local police and armed forces officers, as this year's show will host the 1<sup>st</sup> Police International Forum with the participation of 15 international delegations called upon to discuss false document control.

### ► CONTACT

Fiera Milano Rassegne  
Rho Exhibition Center, Milan, Italy  
Tel.: +39 02 499 76221 · Fax: +39 02 499 76250  
info@fieramilano.it · www.sicurezza.it





# Am I safe traveling home?

Through intelligent security solutions with Siveillance, we help make the world a safer place.

Today, half of the world's population lives in cities. On a global scale, there is a growing demand for reliable security solutions that keep people safe and secure. In addition, keeping critical infrastructure secure and operational, such as airports, subways and utilities is vital for businesses, governments and society. With our innovative and user-friendly Siveillance™ portfolio we help our customers achieve their desired level of security and peace of mind – providing them with intelligent solutions to protect people, goods and the environment worldwide. [www.siemens.com/buildingtechnologies](http://www.siemens.com/buildingtechnologies)

Answers for infrastructure.

**SIEMENS**





## FIRE PROTECTION

# Unseen Until Needed

## Invisible Fire Protection in the New Acropolis Museum

**Stöbich has installed its textile fire protection closures in the world's most spectacular new museum building. 'Invisible' fire protection systems were used to satisfy the extreme requirements of the planners.**

The new Acropolis Museum is one of the most spectacular exhibition buildings of our time. The most modern archaeological museum in the world with an exhibition area of 14,000 m<sup>2</sup> spreads along an area only 300 meters below the Acropolis. Since 2004, 130 million Euro have been invested in the museum construction. From the basement level to the glass superstructure, visitors can view the historical treasures of ancient Greece on multiple futuristically designed levels. Much concrete and steel and even more glass and massive columns typify the new Acropolis Museum.

### Large-scale Sealing Off and Visitor Protection

Even though the new Acropolis Museum stands out against other art collections or galleries on account of its spectacular construction and its historic significance, it still has something in

common with other exhibitions: a large number of visitors in a small area. Up to 10,000 guests are expected to visit the museum every day.

Therefore protection in case of fire not only applies to the unique exhibition items but also

for the numerous visitors. Securing of escape routes and the sealing off of large areas were of high priority in planning. The appropriate solution was provided by 'invisible' textile fire protection closures from Stöbich. They ensure







### Protection Targets and Architectural Vision

The requirements of fire protection planners specified space closures of fire resistance Class E30. However, the design concepts of the architects also had to be considered. This applied especially to the open and transparent construction with extensive exhibition rooms, enormous glass surfaces and separate columns which required 'invisible' fire protection solutions. To satisfy both the technical and architectural requirements, 8 textile 'Fibershield' fire protection closures were used.

Technical implementation of the fire protection concept was not a problem for the systems, which have been tested and approved up to Classifications E 240. Seven of the eight systems were installed on the ground floor, where they seal off the entire area of the cafeteria covering almost 170 m<sup>2</sup> with fire protection technology. All systems close synchronously in case of an alarm, thanks to the central control system. Another textile fire protection closure was installed in the top level of the stairwell. This closure secures the escape corridor required in case of fire across a width of 20 m. All systems close automatically and are not motor-driven and therefore external energy and fire-resistant cabling are not required.

into the architecture as elegantly as possible. To ensure the textile closures were not visible for visitors, all housings were integrated in suspended ceiling systems. The remaining visible closure strips were adjusted in colour to the respective background by means of powder coating. The guide rails also received an appropriately coloured surface coating. When idle, all systems can hardly be seen after assembly is completed and have been harmoniously integrated into the general appearance of the museum.

### Swift Access for Inspection Work

Opportunities to carry out maintenance work are seldom when there are so many visitors and long opening hours. In order to ensure that repair and maintenance work can be carried out simply and swiftly on the installed systems, appropriate accesses have been planned. The fire protection closures are easily accessible after assembly via these hidden inspection openings, requiring little time and technical effort.

Security, Hall 1, Stand 110

maintenance of the fire sections defined by the planners as well as safe and accessible escape corridors in case of fire.

### Invisible Fire Protection

In addition to meeting technical specifications, the fire protection concept has to be integrated

### ► CONTACT

Olaf Grunenberg

Stöbich Brandschutz GmbH, Goslar, Germany  
Tel.: +49 5321 5708 0 · Fax: +49 5321 5708 88  
o.grunenberg@stoebich.de · www.stoebich.de



## You're safe with C-TEC

Currently trading in over 60 countries worldwide, C-TEC is the UK's leading independent manufacturer of fire alarm control panels, voice alarms, disabled refuge systems, call systems and audio-frequency induction loop amplifiers.

With third party product certifications and factory process approvals from the BSI, LPCB and VdS, you can rest-assured C-TEC's products comply with all relevant British and European design and performance standards.

If you're looking for quality life safety electronic equipment, You're Safe With C-TEC.

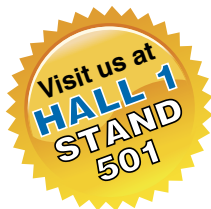

+44 (0)1942 322744

sales@c-tec.co.uk

www.c-tec.co.uk

## COVER STORY

# Lasers in Security

## The First Laser Scanner Certified with VdS Class C

Protecting persons, securing valuables, preventing (or at least the early detection of) crime, electrical and electronic systems for secure building automation are increasingly gaining in importance. The technological solutions are correspondingly innovative. Matthias Mezger, Manager of Marketing and Sales Building Automation at Sick, takes a look at the developments in the use of lasers for intrusion detection.



An efficient coordinated combination of mechanical, structural, organizational and intrusion signaling measures is necessary in order to effectively protect objects in public, industrial, commercial or residential buildings from criminal activities. Peter Fasold, Detective Chief Superintendent in Bavaria's State Office of Criminal Investigation and responsible for crime prevention, clarifies the importance of coordinating all protective measures: "Intruder Alarm Systems must be coupled as efficiently as possible with the mechanical security equipment so that perpetrators are prevented from completing their intended action until the authorities alerted by the intruder alarm system can reach the scene of the crime."

Electrical and electronic systems, however, are not only important constituents of effective protection against break-ins, but also take on tasks in the automation of buildings and ensure safe operating processes. Electronic people-counting systems, whose information can be used for controlling air-conditioning or evacuating buildings, are increasingly being employed to detect individual persons, flows of people and the direction of movement in shopping malls, at airports or at exhibition grounds, for example.

### Outside In

Reliable monitoring against break-ins, theft and vandalism generally already begins on the grounds around the building to be protected. Typical tasks working from the outside inwards include monitoring perimeters, fences and walls and the detection, camera guidance and tracking of persons or objects on open ground. Then attention must be



Vertical monitoring: large fronts are entirely monitored with a LMC12x unit mounted externally on the facade.



Matthias Mezger,  
Marketing and Sales  
Manager Building  
Automation

paid to securing facades and roofs, monitoring ceilings and preventing breaches above ground level. Finally monitoring doors, gates and paths and protecting individual objects such as paintings or other exhibits in museums and art galleries must complete the security concept.

Despite the wide variety of these tasks, the technology of the measuring laser scanner has successfully established itself as an innovative solution approach. Peter Fasold confirms this from his experience: "Laser scanners are highly suitable for area monitoring, both indoors and outdoors. They offer flexible adaptation of the monitored field as well as the provision of signals and alarms. Spurious and false alarms are virtually ruled out by intelligent electronic evaluation. Moreover, they are proof against vandalism, sabotage and tampering, and require minimum installation effort as a result of their single-device design."

### High Security

Whether security equipment for reporting break-ins or solutions for safety management, Sick's





Horizontal monitoring as required: all the open ground is monitored during the night, whilst during the day the access path is excluded from the monitoring – and can thus be used without setting off an alarm.

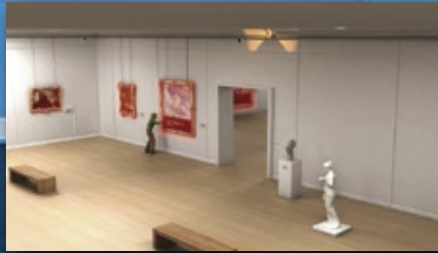

Whether the entire wall is protected with an optical curtain or just individual pictures – artistic pleasure is unimpaired while the museum is open and the exhibits are still protected against theft when it is closed.



Single-entry access control gates are equipped with Sick light grids at airports in order to achieve reliable individualization of persons and detect the direction of movement.

product portfolio offers a wide range of sensor solutions for both areas (some of which are VdS and TÜV certified), as well as the corresponding application-related consulting expertise. A good example of this is the new LMC 12x from Sick; it is the world's first area laser scanner to be granted Class C certification by the Association of German Insurers, and thus also recommended by the police.

The proof of their reliability is demonstrated by the several hundred laser scanners of differing types that are already used to monitor nuclear sites and that have made Sick the market leader in this field. Peter Fasold confirms the suitability of the systems: "The TÜV's approval for [their use at] nuclear plants was applied for and granted as long ago as 2004." Laser scanners, however, are also increasingly being used for other tasks and in other surroundings, for example to monitor walls in galleries or museums. Sick has consequently developed a unique laser scanner solution to protect exhibits, indoor areas and corridors as well as to monitor ceilings.

### Meets the Mark

The LMC12x laser scanner is a measurement system specially adapted for use as an intruder alarm system. This solution was the world's first system to be certified in Class C by the VdS Schadenverhütung GmbH in line with Guideline No. 2117 and applying test method VdS 2485 in order to confirm its suitability for use as an intruder alarm system as required by insurance companies. The unit not only offers increased response sensitivity and detection accuracy, but also enhanced protection (such as integrated sabotage protection) against attempts to defeat it in an active or inactive state. Class C is the most demanding approval standard and is recognized throughout Europe by national certification organizations, or at least used as a basis.

In this connection, for both installers and users, it is important to mention that the associated mounting set for the LMC12x (for mounting the scanner) also meets the demands of VdS Guideline 2312, so that mechanical tampering can also be ruled out.

The LMC12x was designed for use indoors and is in Environment Class II according to VdS 2110. Sick's product portfolio includes other indoor scanners which, depending on the necessary range, resolution, scanning angle or response times, provide optimum solutions for various applications. The laser scanners are supplemented by vision systems and light grids with which windows, duct openings or skylights can be optimally monitored. A variety of laser scanners and photoelectric switches are also available for outdoor use. These will soon be supplemented by the LMC13x, which will meet the VdS Environmental Class IVa.

### Efficiency and Security Management

In addition to sensors for detecting burglaries and signaling alarms, solutions for optimizing processes and maintaining organizational security regulations are increasingly coming to the fore in building automation. Almost all applications involve the detection and counting of persons as well as the detection of the direction of motion of both individuals and crowd flows. This information is necessary, amongst other things, for energy-optimized control of heating, air conditioning and ventilation equipment; the temporary closure of overcrowded areas, floors or parking levels; the organization of evacuation measures as well as for marketing and logistical purposes.

Depending on the task and installation conditions, a range of sensor technologies (such as ultrasonic sensors, photoelectric switches and photoelectric proximity switches, light grids, vi-

sion sensors, bar code readers and, of course, laser scanners) are suitable for such people detecting and counting applications. With these devices, Sick's product portfolio provides great potential for efficient and high-availability building automation, such as for access control, monitoring doors, gates and paths, for counting persons or for singling out persons or vehicles in single-entry access control gates.

With its range of monitoring and signaling sensors for building security, and its control and regulatory solutions for facility information management, Sick can meet numerous tasks in building automation from a single source. These are supplemented by the comprehensive technology and implementation expertise available to the company's end-customers, users, installers, system integrators and other security companies within the framework of non-binding application-related support. This ranges from manufacturer-neutral tendering, through project planning up to after-sales service for Sick products. These all result in efficient solutions for building security and monitoring-relevant operational processes with high availability, providing long-term investment protection.

### ► CONTACT

Sick Vertriebs GmbH, Düsseldorf, Germany  
Tel.: +49 211 5301 0 Fax: +49 211 5301-100  
info@sick.de · www.sick.de

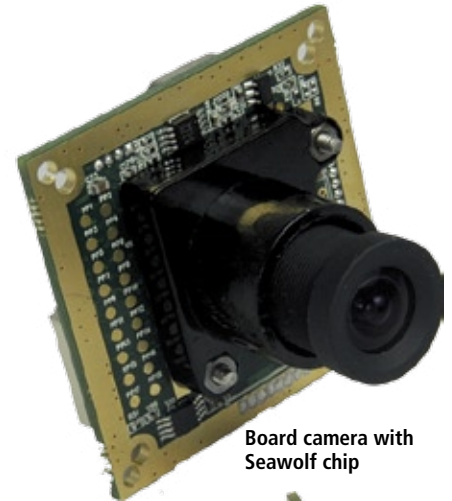

**Finding the right security camera for every application is a challenge for system integrators, installers, end users, and even manufacturers.**

**The Challenge for System Integrators:** Integrators have to be experts on hundreds of different kinds of cameras by dozens (or more!) of manufacturers. To make things more complicated, integrators may not, because of purchase requirements, even have access to the best cameras for a particular job.

**The Challenge for Installers:** Installers have to set up cameras to solve specific problems. They have to be familiar with many different camera models and the set up procedures for all of them. This requirement could

translate to more installation time costing the integrator money.

**The Challenge for End Users:** End users have to select the right cameras. They can't pick a single type of camera and expect it to work in each area covered by the security system. Compounding this problem, end users commonly do not have the domain expertise to know specifically what cameras they need.

**The Challenge for Manufacturers:** In order not to lose sales, manufacturers attempt to create cameras specific to each vertical market and for every type of video problem. However, this is an impossible task, so a manufacturer may find that they offer cameras that work in one corner of a retail store, but only a high

resolution camera produced by their competitor works in another area.

**Looking for a One-size-fits-all Solution** In today's market, no camera is a one-size-fits-all solution. Different scenarios create the need for a wide range of cameras:

- An environment that is backlit –such as the inside of a building or vehicle looking outside, on a loading dock, or in a lobby – requires a camera that offers wide dynamic range (WDR). Dynamic range is the ratio of the brightest image that can be captured by the imaging system to the darkest image that can be captured simultaneously in the same video frame. Light intensity greater than the brightest possible image will cause the sensor to saturate to white, while

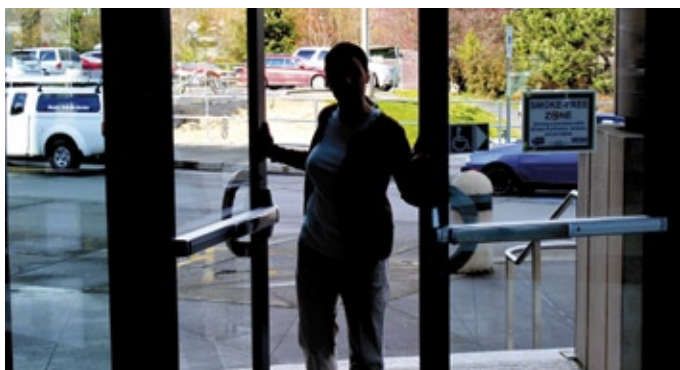

This images compare traditional analog cameras with Seawolf: This set shows a typical backlight situation. The CCD has a beautiful picture of outdoors, but you can't identify the woman. The next image shows how Seawolf corrects the backlight problem.



light intensity less than the darkest possible image will not register on the camera's image sensor. Both of these conditions distort the image, hiding potentially vital information that lies outside the dynamic range of the sensor. WDR cameras are capable of capturing highlight and shadow detail – including backlit images – in the same scene. The greater dynamic range, the more significant improvement in image quality in scenes consisting of both bright and dark areas.

- Some situations need cameras that are capable of capturing natural color in any lighting. For instance, security personnel watching monitors in casinos need to be able to distinguish between red and black playing cards as well as the color of the chips in both well-lit and lowlight areas. Natural color is also important in identifying people where subtle differences in skin tone and clothing shades can make a difference when capturing and prosecuting a suspect in a crime.

- Video is often used for license plate identification, facial recognition, and in transit applications where reading the markings on train cars or buses is essential. These scenes require high resolution cameras which make it easy to distinguish image features and details.

- Additional challenges for security cameras include lighting issues such as glare and reflections. These problems can cause image artifacts including vertical smear and pixel blooming which make the video unusable for identification or prosecution. A security system that cannot produce actionable images is a waste of money. Period.

And when and if an integrator or end user gets a handle on all of the situations above, they are often faced with a new challenge – lowlight! Envision a warehouse with an indoor camera aimed at its loading dock door. The integrator recommended and the end user purchased a camera capable of producing clear, noise-free video during daytime hours. The camera's WDR allows it to get clean images of both the inside of the warehouse and the outside dock. However, at night, only emergency lights are kept on. Unfortunately, for most cameras low light equals

no color, limited wide dynamic range, high levels of noise, or in the worst case, no image at all (black). One solution is to add more light, which is expensive and bad for the environment, and another is to use true day night (TDN) cameras. TDN cameras can produce an image in lowlight, but without color due to their reliance on infrared light. A security guard, the police, or a prosecuting attorney won't be able to tell the bad guy in the red shirt from the good guy in the blue. Many integrators and end users are forced to settle for a third option – less than ideal video.

### Retail Store Scenario

Leon, an integrator, does a walk through for a retail store. He notes the location's all-glass store front. The daylight streaming through the windows wrecks havoc on the store's traditional CCD cameras. The analog CCD cameras can't adjust to both the bright light coming in the window and the shadowy areas around the displays. The retailer mentions to Leon that employee theft at the registers is a huge problem for the store and becoming worse. The current cameras capture the point of sale transactions, but the store's security personnel can't distinguish between the money denominations – the orange 50 euro bill looks distressingly like the yellow 200 euro bill.

The store offers high-end jewelry in locked display cases. Glare from the front windows bounces off the cases causing the store's older cameras to bloom. The glare makes it impossible to see if the jewelry removed from the case is put back. To make matters worse, a shoplifter recently stole a small ring. Though the clerk was certain who had taken it, the video recording did not capture the theft.

Finally, the store caters to an environmentally conscious clientele. Store management wants to demonstrate to its customer base that they are on the forefront of the "green" earth movement. One of the ways the store practices this is by having motion-activated lights in the restrooms and by leaving the lights off in the storage area. The storage room is dim with just two small windows at the back. The cameras currently in place are practically useless. Less than ideal

employees have already taken advantage of the blind cameras and are suspected of pilfering merchandise during unauthorized breaks.

### Integrator's Goals

Leon has several goals for this project:

- He wants to win the job by providing the best solution at the best possible price.
- He wants the new system to be installed quickly, saving him technician hours and enabling him to offer a lower bid than his competition.
- He wants to use cameras by a single manufacturer making it easier for his installation team.
- He wants to earn the trust of the client. By demonstrating he has the best, most affordable solution and being able to install the equipment with minimal disruption to the client's business, he hopes to secure negotiated work from this client in the future.
- He wants this client to recommend his integration company to other retailers.

### Integrator's Solution

Leon knows he can meet all of his goals because of a revolutionary new camera chip. The Seawolf chip by Pixim Inc., a leading provider of imaging technology for enterprise security cameras, offers the industry's highest effective resolution, greatest wide dynamic range, and best low light performance at an affordable price. By selecting cameras based on Seawolf, Leon can offer his client cameras that can handle backlight situations, capture realistic color, and eliminate glare in all lighting conditions. Best of all, Seawolf cameras offer 10 times the low-light performance of previous generation security cameras while maintaining industry-leading wide dynamic range.

Now, for the first time, Leon's technicians can install cameras that will work in any lighting condition right out of the box. They will be able to decrease their time spent on the ladder, because they will only have dome and box cameras from one manufacturer to install. They will be able to use the same cameras in the storage room that they use by the jewelry cases.

Boasting 690 HTVL effective, Seawolf delivers the highest usable

Enterprises of reputed trust in us, why not you!



## finger print solutions

Engineered in Germany

### FOD™ Housing



Stainless Steel



Standard out door



Siedle™ baffle



Gira™ baffle



Access Control  
Time and Attendance  
Identity Management

The network-based finger print solution for small and medium sized enterprises as well as company groups.

Reseller searched!



JERRA Soft  
Saargemünderstr. 62a  
D-66119 Saarbrücken  
Tel.: +49 681 85919-0  
Fax: +49 681 85919-29

resolution to the CCTV end user. Traditional, analog CCD-based cameras lose much of their resolution when the video is recorded and reviewed. However, due to Seawolf's high total resolution (horizontal times vertical), its high-quality, color images are preserved by commonly used DVRs and displays. Leon's client will now have high resolution images that can be used for evidentiary purposes following a crime.

#### Additional Seawolf Benefits

Like all of Pixim's chip products, Seawolf is based on Pixim's Digital Pixel System technology. Pixim's technology employs hundreds of thousands of self-adjusting pixels to act like individual cameras, eliminating image compromising visual noise and delivering the highest resolution, natural color and clarity, even in challenging lighting conditions. This all-digital system efficiently captures the whole picture, down to the crucial details. In contrast, traditional, analog CCD cameras use image sensors where every pixel receives the same exposure creating overexposed images in bright areas and underexposed images in dark areas.

Integrators can choose between analog and IP Seawolf cameras based on the requirements of their customers. The Seawolf chip is ideal for IP cameras. Users of IP cameras will benefit from Seawolf's global electronic shutter, progressive scan image capture, full D1 resolution at 30

frames per second, and low network bandwidth requirements.

Seawolf-powered cameras produce noise-free, clean images which require less hard drive space to store video content. End users gain tremendous flexibility in how they can use that additional storage capacity. For instance, they can store additional hours of video per camera, store higher-quality video for one or more cameras, increase the video frame rate stored for one or more cameras, or use smaller, less-expensive hard drives and backup systems for video recording.

#### Seawolf Meets the Challenges

Seawolf meets the challenges for every group:

- System Integrators can now offer Seawolf cameras to their customers knowing they are selling cameras capable of excelling in all lighting conditions including low light. They can select analog or IP cameras and expect good results. They can partner with a leading manufacturer and save money by reaching volume discount levels. Plus, installation hours and the number of return site visits will decrease saving them money.
- Installers can now focus on one camera line, thoroughly learning the set up procedures. They will decrease their installation hours knowing that cameras based on Seawolf can be installed in any location regardless of lighting conditions and still produce high-quality video right out of the box.

- End users now have the option of cameras that will help them deter crime and prosecute criminals if an incident does occur. They will save money by reducing costly storage space and through reduced installation times and inconvenience.

- Manufacturers will be able to use a single, digital chip, rather than more complicated mixed-signal, multi-chip sets to develop new camera portfolios. Single board camera modules based on the Seawolf chip make it easier for manufacturers to develop compact camera formats. Their Seawolf-based cameras will offer true all-lighting capability, meeting the most demanding image quality expectations across the security market, including retail, banking, gaming, education, transit, commercial, and industrial applications.

Trusted manufacturers serving the European market, such as March Networks, GE Security, Dallmeier, Genie CCTV, Ovii, and Camtron, are already planning production of Seawolf-based cameras.

#### ▶ CONTACT

Pixim Inc., Mountain View, CA, USA  
Tel.: +1 650 9340550 · Fax: +1 650 9340560  
[www.pixim.com](http://www.pixim.com)

# Public & Private partnerships for security

- ANTI-INTRUSION
- FIRE PREVENTION
- PASSIVE DEFENCE SYSTEMS
- HOME & BUILDING AUTOMATION
- INTELLIGENCE AND ANTI-TERRORISM
- LOCAL POLICE FORCE  
AND PRIVATE SECURITY GUARDING

# SICUREZZA

fieramilano Rho, 17-19 NOVEMBER 2010

[www.sicurezza.it](http://www.sicurezza.it)

Concurrently with

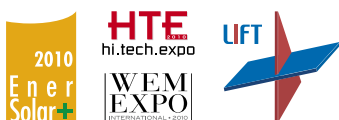

Strategic Alliance Partner



The UNITED NATIONS Interregional Crime and Justice Research Institute







SECURITY FOR RETAIL

# Behind the Scenes at Uniqlo

## SureVue and Panasonic Step-up in High-profile Retail Location

**A classy gala party marked the opening of Uniqlo's European flagship store in the trendy Opera District of Paris, on Rue Scribe only steps away from the famed Paris Opera House, Palais Garnier. Uniqlo is Japan's leading clothing retail chain with more than 800 stores currently open. The multi-level 2,100 m<sup>2</sup> flagship store features innovative digital signage as an integral element of its merchandising strategy. Panasonic iPro box and dome cameras and wrap-around LED panels as well as 53 of Panasonic Visual Display Europe's plasma displays are integrated into the interior design. Panasonic NM Stage digital signage software is installed on SureVue3A fanless player PC's from MediaVue Systems.**

### Challenges

The store was built inside an existing 19<sup>th</sup> Century Paris landmark building. The cabinetry that houses the displays, players and other electronic components was designed with aesthetics as the first consideration. Functional considerations such as adequate space, good ventilation and easy access to components were secondary. Accessing displays and players generally requires extensive disassembly of cabinetry and frequent removal of equipment.

Failed displays or players could be costly and disruptive to store operations. Additionally the confined spaces and limited ventilation created a difficult operating environment for PCs.

The different display enclosures meant that the players also needed to be installed in different ways in various locations. Some needed to be mounted directly to the backs of displays. Others needed to be mounted on walls or in nearby equipment cabinets. The high-perform-

ance video output produced by NM Stage also required a PC player with significant performance. Players with low-power, low-performance CPU's could not meet the requirements.

"For us SureVue completed a very strong digital signage offering for Uniqlo, especially with the need for a focus on design and given the tough, continuous operating conditions within Uniqlo's flagship store. Added to that we need a player that could deliver strong video performance and high reliability while operating continuously in harsh environments, MediaVue gave us all of this within a compact sized unit," said Toru Tsubosaki, Business Development Manager

### Solution

Panasonic System Networks Europe (PSNE) turned to MediaVue to provide a PC player solution. The SureVue3A is designed to perform reliably in difficult environments, particularly dusty, dirty and hot environments like those inside the Uniqlo display cabinets. There are no fans that can clog and fail. The special Seagate drive used in SureVues is the only 2.5 drive designed for continuous duty operation in rugged conditions. The passive cooling system on the SureVue3A can maintain proper operating temperatures even under heavy loads in with limited ventilation.

The small size of the SureVue3A together with the built-in mounting tabs enabled installation of the units in a range of situations. With its integrated ATI graphics and powerful 2.1GHz dual core CPU, the SureVue3A delivered the performance required to drive NM Stage and wide range of content that would be presented. MediaVue also provided assistance to Panasonic to develop the project software image that included NM stage and an initial content load. This image was then factory installed on all units. The SureVues were then shipped directly to the installation contractor ready for installation and network activation.

Tsubosaki commented about the system: "We identified MediaVue purpose built digital signage PCs and specifically their SureVue3A as the best possible solution because of their design which is intended to meet the wide range of performance and installation requirements essential for the successful implementation of the Uniqlo project. Now, after almost a full year of daily operation, we have not experienced a single failure with the SureVues." With Panasonic expertise in providing complete digital solutions and SureVue's ultra high reliability for digital signage, the Uniqlo Paris store looks set to continue using the system for many years to come.

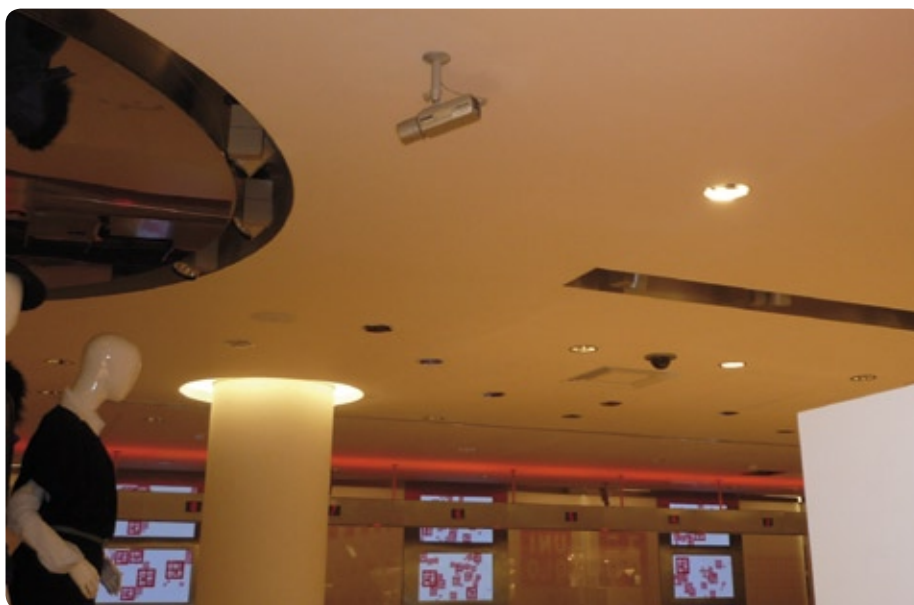

Panasonic iPro box and dome cameras guarantee a high level of security

### ▶ CONTACT

Panasonic, Bracknell, United Kingdom  
Tel.: +44 844 844 3888 · Fax: +44 1344 853 221  
[www.pss.panasonic.eu](http://www.pss.panasonic.eu)

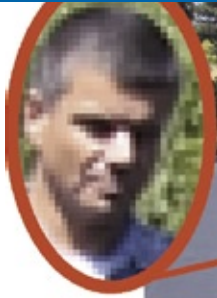

## CCTV

## HDcctv: The Third Way

### The Low-cost Path to High-Resolution Surveillance Video



Todd E. Rockoff, Ph.D.,  
Executive Director,  
HDcctv Alliance

**HDcctv is a new digital camera interface technology bringing uncompressed HDTV to surveillance monitors for the first time. HDcctv joins CCTV and IP network video as a third camera interface technology option for use in video surveillance systems.**

The choice of camera interface technology has a surprisingly significant impact on the cost-effectiveness and value of a physical security system. This article introduces HDcctv and compares and contrasts it with CCTV and IP network video. HDcctv allows the installed base, as well as new installations, to reap the benefits of megapixel

surveillance at lower cost and greater convenience than was heretofore possible. HDcctv represents a great business opportunity for video surveillance equipment dealers, because every existing CCTV customer is a candidate for an upgrade to high-resolution surveillance with the simple addition of some HDcctv cameras along with a complementary DVR and/or IP encoders. In addition to its appeal to the small CCTV customer, HDcctv is potentially indispensable to designers of large-scale physical security systems: Even where IP networking is the integration fabric, HDcctv provides highest-quality camera video feeds at minimum costs of equipment, installation, and operation.

The HDcctv Alliance is the non-profit global consortium formed to develop and promulgate the HDcctv standard that assures the interoperability of high-definition, closed-circuit television equipment. The goals of the Alliance are to encourage surveillance system developers to consider HDcctv equipment in upgrading existing surveillance systems and in designing new ones, and to reduce the risk to manufacturers entering the industry.

#### Video Surveillance System Architecture

Figure 1 gives an overview of a remotely managed physical security system, which provides for services (such as guarding and monitoring) as well as physical systems (e.g., video surveillance, intrusion alarms, access control, and fire suppression). The video surveillance system itself includes devices such as cameras, DVRs, network



Comparing SD vs. HD in a surveillance application in a parking lot.

equipment, monitors, remote servers, and PCs running video management software.

While conventional video surveillance systems are based entirely on CCTV cameras, Figure 2 depicts a modern video surveillance system that includes IP as well as CCTV cameras (with  $C_i$  denoting a CCTV camera). Various devices are inter-connected over a variety of media in the video surveillance system. Each camera is connected to one other device, for example a repeater, DVR, router, encoder, NVR, etc. The camera interface technology includes the specification for signaling between the camera and its paired device.

Figure 3 depicts a new kind of video surveillance system incorporating IP, CCTV and newly available HDcctv cameras, with  $C_i$  denoting a CCTV camera and  $H_j$  denoting an HDcctv camera.

Cost effectiveness is a paramount goal in designing a physical security system. Since the video surveillance component accounts for a large share of the system's perceived security value and commands a majority of the system's budget, its cost-effectiveness is critically important in the overall architecture of the physical security system. The choice of camera interface technology has significant implications for the cost-effectiveness of the video surveillance system.



# Complete Video IP Solutions from one source

## From private homes to large-scale projects Individual video security solutions for any area

Dallmeier has planned and realised the world's largest IP video surveillance systems. The experience gained through those projects is continuously used in the product development. Therefore, you can also benefit from innovative and proved solutions with small and medium size applications.

*"For what works on a large scale also works on a small scale – and not the other way round."*

Dieter Dallmeier

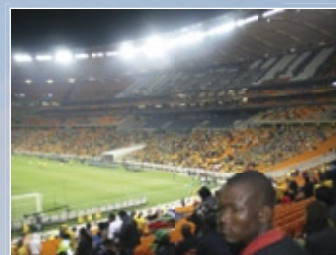

## Whether large or small – Dallmeier offers the right solutions for any application

petrol stations



private homes



banks



retail



premises



branches



## Made in Germany – made by Dallmeier!

For over 25 years, Dallmeier has been developing and manufacturing in Germany!

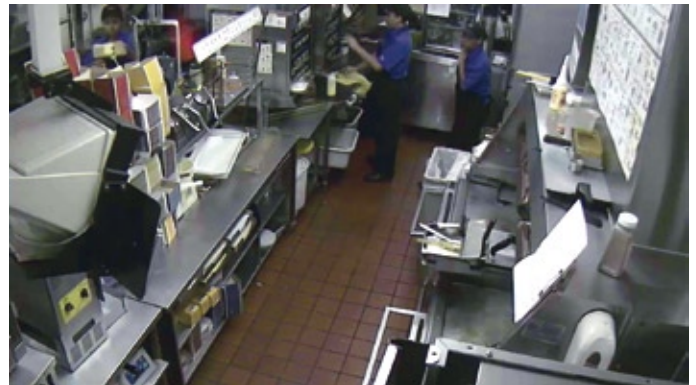

Application of HDcctv in a chain of fast-food restaurants (courtesy of SG Digital).

**The Three Camera Interface Technologies: CCTV, IP Network Video, HDcctv**

IP network cameras have heretofore been a compulsory alternative to CCTV cameras if megapixel resolution is a surveillance requirement. The important differences between CCTV and IP network video are the transmission format and the physical medium. Typically, CCTV delivers analog television signals over coaxial cable, whereas IP network video delivers sequences of packets of compressed video representations over Cat-X cable.

HDcctv, the new alternative, delivers digital HDTV signals over coaxial cable at rates of 1.5 Gb/sec. HDcctv cameras directly re-use the coaxial cables of existing CCTV installations while digitally delivering, for example, 2-megapixel frames at 30 frames per second. Thus, HDcctv is an appealing alternative for the video surveillance system designer as it offers higher resolution than CCTV at similar cost, while preserving the CCTV infrastructure and operating interface. This means that an upgrade to HDcctv potentially requires no new cabling and little or no training of installers and operators. Thus, HDcctv delivers high resolution at greater convenience and lower cost than a transition to megapixel IP network cameras. Moreover, HDcctv cameras deliver highest-quality images which are not compressed for transmission.

**The HDcctv Standard**

Version 1.0 of the HDcctv standard adopted by the HDcctv Alliance specifies SMPTE-compliant HDTV signals (720p25, 720p50, and 1080p25) over conventional coaxial cable. (For reference, a 1080p image contains about 2 million

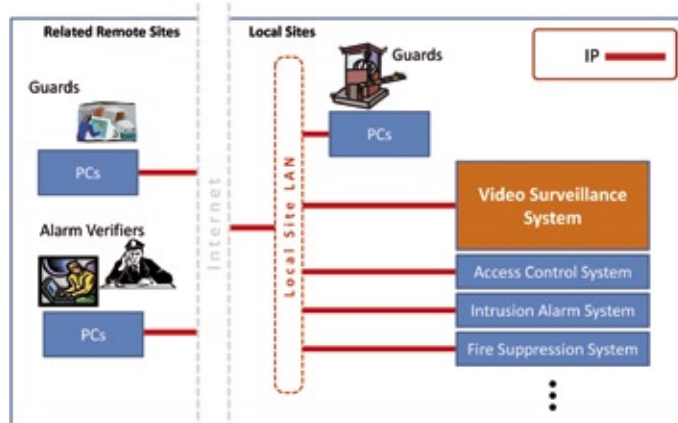

Fig. 1: A Remotely Managed Physical Security System

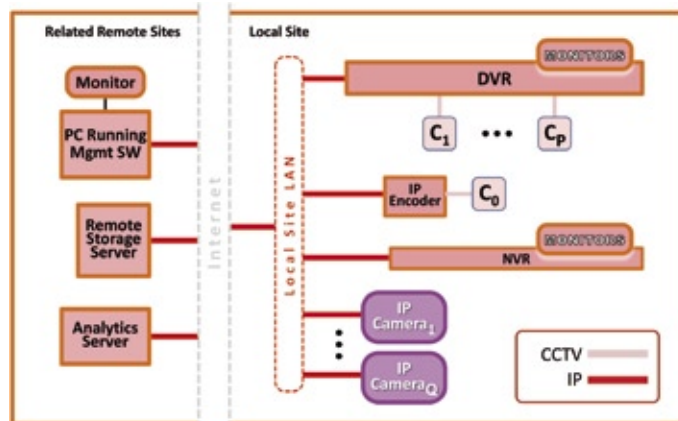

Fig. 2: A Modern Video Surveillance System with IP and CCTV Cameras

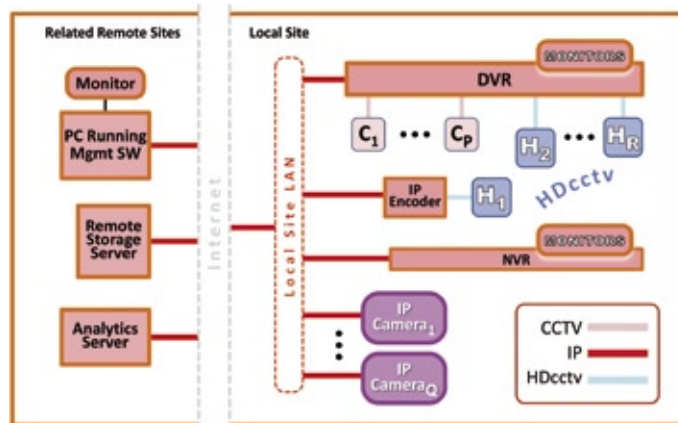

Fig. 3: A New Video Surveillance System – CCTV, IP and HDcctv Cameras

provide for signal transmission over 300 m of RG-59 coax or

100 m of Cat-5e, definition of a physical layer for optical fiber, bi-directional exchange of control information, bi-directional audio, and even up-the-cable power.

**Which Camera Interface Technology Is Best?**

The customer's needs determine the video surveillance system requirements, including the resolution, frame rate, fidelity, and duration of stored video, search capabilities, analytics, and the means for controlling the system. There may be no one type of camera interface technology that best fits the needs of all applications. When specifying camera upgrades, system designers usually base the choice for each camera on economic considerations.

Since CCTV is the camera interface technology in the vast majority of installed video surveillance systems, a design objective in upgrading many physical security systems is to preserve the existing CCTV infrastructure, in particular the coaxial cables and as many cameras as possible. HDcctv meets this objective. Video system designers have CCTV cameras, IP network cameras, and now HDcctv cameras at their disposal. The video system that provides the required forensic evidence at least cost may include a mix of all three types of cameras.

The predominance of CCTV in the video surveillance installed base means that many pragmatic buyers are reluctant to adopt IP network video cameras because for them new CCTV cameras are more convenient to install and less expensive than IP network cameras. However, while CCTV offers compelling economic advantages for standard-resolution video, CCTV has a practical resolution limit of



540HTVL, and most CCTV cameras are capable only of very low vertical resolution. A need to exceed these limitations prompts the search for higher-resolution alternatives. IP networking imposes no fundamental limit to image resolution; therefore for some applications, the resolution advantage of megapixel network cameras justifies the inconvenience and cost of switching to IP networking. However, many potential buyers who want higher resolution appear to be waiting for an easier way to upgrade their existing CCTV systems.

Video surveillance system architects recognize that network-enabled DVRs are sometimes more cost-effective network edge devices than cameras. That is, a DVR can serve as an effective terminal of the IP network (whether Internet or LAN) linking the video surveillance system to the other elements of the physical security system. Such a DVR removes the requirement to extend the network itself to each (or any) camera. Thus, upgrading a CCTV system to HDcctv is as convenient as replacing or adding a CCTV camera while upgrading the DVR.

The latency of signal transmission across an HDcctv interface is imperceptible, whereas the latency of signal transmission across an IP network video interface is appreciable, due to the compression performed by IP network cameras prior to transmission. The low latency of HDcctv interfaces is a distinct advantage for applications requiring megapixel-resolution speed (PTZ) domes.

Moreover, IP networking incurs a variety of costs beyond those typically associated with CCTV or HDcctv. One often-overlooked cost of IP network video for the camera interface is that IP is designed to tolerate varying packet transmission delays and even packet loss. Of course, video surveillance requires uninterrupted delivery of the video signal. Typically, an IP network that can guarantee zero packet loss is a relatively expensive one.

At equivalent resolution, CCTV cameras deliver higher-quality video than IP network cameras, because CCTV video does not suffer from the impairments introduced by significant compression. HDcctv cameras also transmit video that is free from video artifacts introduced by the significant compression performed by IP network cameras. But HDcctv cameras deliver true 720p25, 720p50, and 1080p25 signals, which represents a distinct resolution advantage over CCTV.

HDcctv has an advantage over both CCTV and IP network video with respect to the complexity of the standard itself. Interface standards are valuable because they obviate buyers' potential concerns about interoperability, thereby increasing sales, while reducing manufacturers' risks associated with entering the market, ultimately minimizing product prices. To the chagrin of product manufacturers, CCTV encompasses a variety of transmission standards: NTSC, PAL, SECAM, etc. To the frustration of integrators and

installers, there is an even greater variety of IP network video transmission standards, which, along with a great diversity of control interfaces for IP network cameras, presents significant interoperability risk to the end customer. Meanwhile, as a unified global standard managed by the HDcctv Alliance, HDcctv presents a less complex array of formats than either CCTV or IP network video. The HDcctv Alliance aims to make the HDcctv standard rich in features yet inexpensive to implement.

As the HDcctv industry matures, HDcctv equipment should become available at cost points similar to good-quality CCTV equipment. For these reasons, it is timely for video surveillance system designers to consider specifying HDcctv in new projects. Designers should be aware that only products bearing the distinctive HDcctv logo are certified as complying with the HDcctv standard. The logo assures buyers of product interoperability.

### Applications of HDcctv

HDcctv should be considered for any situation or application requiring high-resolution video. HDcctv is especially appealing for upgrades of existing CCTV systems. HDcctv Alliance members report applications of prototype HDcctv equipment around the world, from individual jewelry shops to municipal highway safety to a national postal service.

One HDcctv Alliance member's customer is taking advantage of prototype HDcctv cameras in a chain of fast-food restaurants (see pictures 1 and 2). The end customer owns four drive-thru stores, representing an existing investment of 26 CCTV cameras and 4 DVRs. The customer is able to access the DVR in each store via the Internet. The customer had been thinking about upgrading his DVRs to take advantage of H.264 compression. While he did not want to change the whole infrastructure over to IP networking, the customer had also been requesting higher-resolution video on some camera views. HDcctv cameras immediately delivered the desired upgrade, without changing the security system in any fundamental way: the installer had only to set up the new DVR in each restaurant, unscrew the old cameras, and screw in the HDcctv cameras. The technicians were delighted with the ease of installation and commissioning, while the owner was able to negotiate for lower insurance rates due to the improved surveillance quality.

As another example, the Gaming Commission of the U.S. state of South Dakota recently sanctioned prototype HDcctv equipment for use in casinos. Several systems have been installed. The customer determined that upgrading some cameras to HDcctv delivered a better economic return than the conventional path of replacing the cameras with newer CCTV cameras. It is worth noting that the customer did not consider changing over to an IP networking infrastructure. The end customer reports having increased

his ability to monitor and prosecute table fraud: high-fidelity uncompressed images delivered at high frame rates make it much easier to identify and prosecute fraud. Also, the greater pixel coverage achieved per camera with HDcctv, along with the wider 16:9 aspect ratio, reduces the total number of cameras needed to cover some gaming pits.

### Take-away Message for the Video Surveillance Equipment Dealer

Every CCTV customer contemplating a DVR upgrade is a candidate for the addition of some HDcctv cameras. The target market is the installed base, in which many cameras lack sufficient image resolution for modern surveillance requirements. It may be that a substantial fraction of the installed base is reluctant to pay for the IT overhaul needed to accommodate IP network cameras but would be eager (after a simple demo) to obtain HDcctv cameras while in the process of replacing the DVR anyway.

### Take-away Message for the Physical Security System Designer

Even if the physical security system relies on IP networking for integrating its various services and systems, choosing HDcctv instead of IP networking for the high-resolution cameras introduces true HDTV video at lower costs of equipment, installation, and operation. This disparity is especially pronounced for those existing CCTV systems for which HDTV resolution is required only on some camera views. HDcctv is not intrinsically expensive, so any designer specifying high-resolution video should consider HDcctv. Some scenes may best be covered by HDcctv cameras, even if not all are.

### Acknowledgement

*I would like to thank Gareth Heywood, Randy Jones, Roy Karunakaran, Gary Perlin, and Gloria Reiss for their generous contributions to this article.*

### CONTACT

#### Todd Rockoff

HDcctv Alliance Ltd., Holgate, Australia  
Tel.: +1 408 5121351 · Fax: +1 208 7121351  
rockoff@highdefcctv.org  
www.highdefcctv.org

CCTV

# Short Waves over Long Distances

Innovative Wireless Solutions Bridge Network Gaps



© Philippe BONNEAU/fotolia.de

**The Diepholz, Germany based Value Added Distributor Secura Systems markets three products to cover the different demands made of terrestrial radio links. Each of these is optimized for the distance it is expected to cover and operates in the relevant unlicensed frequency band for the country of installation. Contemporary and innovative features enable a wide range of applications.**

If you've tried installing a satellite dish for a friend recently, one of the first things you will have checked is if there is any object between the satellite and where you want to mount the dish. Reception from geo-stationary orbit is strictly line-of-sight only. Coming down to earth and a little further down the frequency spectrum, but still in the Gigahertz range, a clear line of sight between transmitter and receiver significantly helps signal strength and thereby a robust connection. However, Secura's 'Wave' range of microwave links does not necessarily need an unobstructed path in order to provide reliable point-to-point or point-to-multipoint communication at respectable data rate.

The Wavesprint, the 'baby' of the family, is built to cover distances of up to 1 km and, depending upon local conditions, will provide up to 54 Mbps of bandwidth. Typical applications for this system are the transmission of data between company buildings that are separated by roads or rivers for example, to deliver CCTV images from distant cameras to a central control room or to provide that difficult last-mile access for broadband data or voice services.

The radio equipment and integrated antenna are both contained in one ruggedized housing that is hardly bigger than a man's hand. All that is needed to set up the link comes in one box and everything is pre-configured for rapid deployment. A built-in SNMP interface also allows easy integration with existing network management and monitoring tools.

## In for the Long Haul

Where the application demands a longer range, the Waveflow system provides point-to-multipoint bridging at up to 5 km. It also meets the requirements of bandwidth-hungry CCTV by supplying data rates up to 108 Mbps, depending upon conditions. This is equivalent to the performance of cabled Ethernet and represents a transparent link that bridges a gap that cannot be filled by cabled solutions.

The high-end solution for wireless access applications is called Wavemax. It will typically find application with utility companies and telcos, with local government and emergency ser-





vices but also in security installations where a range of up to 40km is required. The Wavemax can form part of a WAN or MAN configuration and also help to efficiently extend enterprise networks.

### Fit to Burst

This system can make do with near-line-of-sight and, thanks to the OFDM encoding employed, it copes well with potential interference sources. Security and throughput are ensured by a unique packet compression and bursting technology together with many flavors of WEP and WPA protection, MAC address filtering and 802.1x radius client support. The Wavemax is optionally available as a stand-alone unit for use with a separate antenna or integrated into one casing that is weatherproofed to IP67+ standard.

With this comprehensive range of equipment, the list of potential applications becomes very long indeed. Some case studies demonstrate how the installation of these radio links can provide very effective solutions to everyday problems. The London Borough of Hackney, for example, is responsible for an inner-city area that features many high-rise residential buildings. The council has installed a large number of CCTV cameras over recent years to act as a crime deterrent and to provide peace-of-mind for residents. The challenge was to get the video stream from the cameras to the control room with minimal civil engineering work.

The DSSL Group of Basildon specializes in supplying CCTV and access control systems and recommended that the council use Secura Wavemax equipment to transport the video streams. As many as ten cameras can be working on one building and this amounts to a significant total bandwidth requirement. Here the system's software accelerators handling the compressed data deliver up to 21 Mbps of throughput over a range of some 2km. This conforms with the Hackney project requirements and also gives room for the planned future system expansion with the addition of internal access point hotspots linked into the existing Wavemax backbone.

### Ring Road

That security at airports is both high and involves a lot of effort is known to every air traveler. The responsible security managers at one airport decided to move the first line of defense against terrorism and other crime by employing automatic number plate recognition cameras on the approach roads. A total of 28 cameras deliver images 24/7 to a central control and processing point over compact Wavemax and Wavesprint systems that are mounted on lamp posts along the perimeter roads at around 4 meters height. This ensures that the radio link is focused along the road, does not cross the airport compound itself and therefore cannot interfere with other essential airport systems that operate on similar frequencies.

These two CCTV applications demonstrate how the Wave series of fixed radio links can be employed to transport data either point-to-point or point-to-multipoint, where cable or fiber solutions would be too expensive or even impossible to realize. Fitted with wide-angle antennas, they can also be employed to transport all types of data between vehicles and fixed points. Train to track, covert observation from vehicles and even VoIP or data transmission from passing ships can all be effectively and reliably implemented by selecting the right system for the specific operating conditions. Effective use of the high bandwidth and long range of these systems can inspire some very innovative value-added applications.

Security, Hall 2, Stand 415

### ▶ CONTACT

Paul André de Jong

Secura Systems GmbH, Diepholz, Germany

Tel.: +49 5441 9923680 · Fax: +49 5441 9923687

paul.dejong@securasystems.de

www.securasystems.de



## True German Originals

### One-of-a-kind IP cameras

- Superior image quality
- Industrial-grade reliability
- Megapixel, CCD, H.264

Full HD • 30 fps

**BASLER**  
VISION TECHNOLOGIES

click. see. smile!

[www.basler-ipcam.com](http://www.basler-ipcam.com)

## SECURITY ESSEN

# The World of Security and Fire Protection

Security Essen Opens Its Doors from October 5 to 8

This year, the organisers of Security Essen promise more area for concepts from fire protection and IT security. During the show more than 1,100 exhibitors from 40 nations will present "The Whole World of Security and Fire Protection Technology". It will be possible to see a large number of product premieres and exhibitors will show innovative security technologies as well as the most modern security concepts. With its comprehensive range on offer, Security 2010 aims to be provider for the entire sector. The organisers are expecting over 40,000 visitors who will come to Essen from all parts of the world in order to obtain information about new solutions and pioneering developments.

## Fire Protection Solutions Will Be Given More Space

At Security 2008, companies and institutions dealing with all aspects of fire protection presented themselves in a compact form in one hall for the first time. The new concept met with great approval. Therefore, an enlarged event section already had to be planned for the following event. On the occasion of Security 2010, the suppliers of preventive fire protection, early fire detection and fire fighting will, in Hall 1, occupy an enlarged area. Under the title "Fire Prevention", the fire protection experts will congregate there. The concept of the fire protection hall will be implemented together with the partner of Security, the bvfa (Federal Association for Technical Fire Protection).

## Information about Everything to Do with IT Security

Nowadays, companies must also be safeguarded virtually more and more; IT security is one of the central questions of the people responsible for corporate security. The IT Theme Park in Hall 4 at Security will give answers. IT security will also be a central field of the forums where experts will, in lectures and demonstrations, provide information on the subjects of security organisation, video, alarm installations as well as IT security.

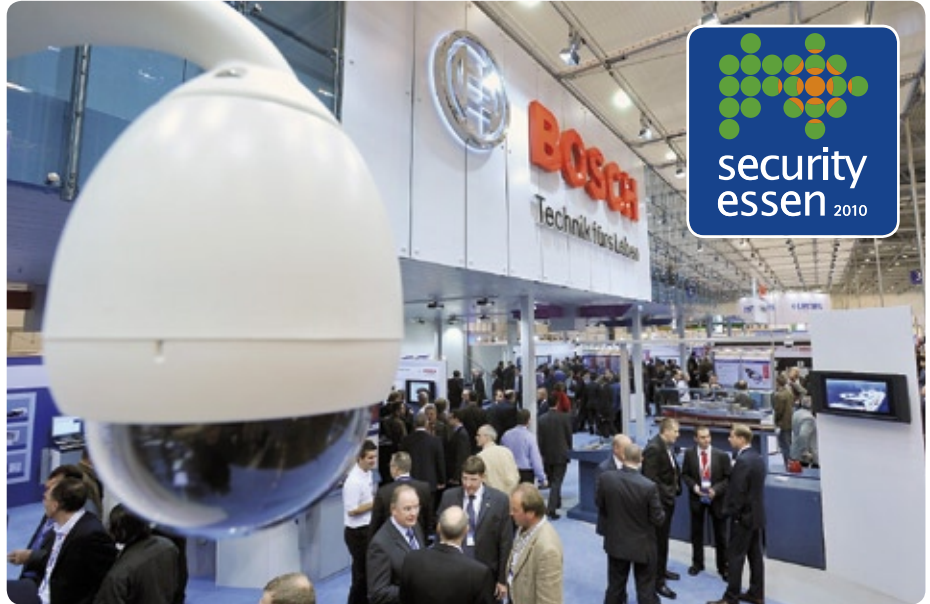

## Essen Security Innovation Symposium

During Security Essen, the Essen Security Innovation Symposium will take place within the framework of the show. Leading European experts from the political, industrial, economic and scientific fields will comprehensively devote themselves to the challenges of civil security. The speakers will include Stefaan De Clerck, Belgian Minister of Justice, Dr. Luigi Rebuffi, CEO of the European Organisation for Security (EOS) industrial platform, and Prof. Wolf-Rüdiger Dombrowsky from Steinbeis-Hochschule Berlin. The Essen Security Innovation Symposium will make an important contribution to a better understanding of the steps necessary for the implementation of research results and their innovations. This will be highlighted by the fact that the Security Research Department of the Research Execution Agency (REA) of the European Commission will participate in the event.

"The event will centre on the search for European and international solutions to all-encompassing problems such as exist in a concrete form and are placing new responsibility not only on the state but also on industry and the economy," explains Prof. Dr. Alexander Siedschlag, Director of CEUSS (Center for European Security Studies at the Sigmund Freud Private University of Vienna) and organiser of the conference. "Assuming responsibility begins with that knowledge at the international level which this symposium would like to accumulate and pass on."

The event will offer a diverse platform for experts to bring up the relevant security aspects within the framework of international presentations. Siedschlag: "Not only here, security as public property will have to approach the question in what way the public and private sectors will best pursue their interdependent objectives in the future in order to be able to jointly protect the society and the infrastructure."

23 speakers from politics, the economy and science who will come from twelve different countries have promised to participate. On October 5, Stefaan De Clerck, Belgian Minister of Justice, will be expected for a speech about the programme of the Belgian presidency of the EU Council in the field of "Home Affairs" and will be followed by Dr. Luigi Rebuffi, CEO of the European Organisation for Security (EOS) industrial platform, who will discuss the consequences of the Lisbon Treaty for the European security industry.

When you attend the Essen show, GIT's Safety and Security team would like to welcome you at our stand in Hall 2 Stand 506

[www.security-essen.de](http://www.security-essen.de)



## SECURITY ESSEN

# Security Innovations

**CEM Systems, a brand of Tyco Security Products, will exhibit its latest security innovations at Essen 2010.**

CEM will display the new version 6 software platform of the AC2000 access control system. Available in German translation option, the CEM AC2000 system gives customers a powerful and fully integrated security management system. At Essen, the CEM AC2000 system will be fully integrated with the American Dynamics Intellex Digital Video Management System. Also on display will be CEM's leading IP card readers including the S610f fingerprint reader and the innovative S3020f handheld 'WiFi' reader for portable access control. The S3020f Portable Fingerprint Reader is a rugged hand-held card reading and fingerprint verification device. It can be used for ID card validation and fingerprint verification at



CEM AC2000 Floatbar of security applications

remote sites or temporary entrances which have no power.



S3020f portable reader with up to 100,000 card and biometric records

Visit CEM at Security Essen on the Tyco Stand 504, Hall 1

## ► CONTACT

CEM Systems Ltd., Belfast, UK  
Tel.: +44 28 90456767 · Fax: +44 28 90454535  
cem.info@tycoint.com · www.cemsys.com

## SECURITY ESSEN

# New Series of Megapixel Cameras

**Vivotek Launches First Supreme Series Network Camera**

**Vivotek is constantly striving to provide the highest quality network cameras to meet the most technically demanding and professional surveillance market requirements. The launch of the Supreme series marks Vivotek's entry into a new era of technology and professional project markets.**

The Supreme series fulfills all criteria required for the most critical application environments. High definition 2-, 3-, 5-megapixel resolutions ensure exceptional details and razor-sharp images. Exceptional 60 fps Full HD ensure smooth, crystal-clear video when monitoring fast-moving scenes or action at high speed. The outstanding sensor and color reproduction technology makes for vivid, clear nighttime vision for all-round surveillance with high image quality.

Vivotek IP8151 is the first Supreme professional-series fixed network camera launching in September 2010. Equipped with Sony's latest sensor technology, dubbed „ExMor“, the IP8151 offers Supreme Night Visibility as one of its chief features, capturing both exceptional details during daytime and offering unparalleled visibility with true color under low-light conditions down to 0.04 lux. Featuring up to an exceptional 30 fps at 1.3-megapixel resolution, the IP8151 captures superb megapixel image quality and with exceptional bandwidth efficiency.

The IP8151 camera supports the industry-standard H.264 compression technology, drastically reducing file sizes and conserving valuable network bandwidth. With MPEG-4 and MJPEG compatibility also included, video streams can also be transmitted in any of these formats for versatile applications. The streams can also be individually configured to meet different needs

or bandwidth constraints, thereby further reducing loading and enabling users to receive multiple streams simultaneously in different resolutions, frame rates, and image qualities for viewing on different platforms.

Additionally, the built-in SD/SDHC card slot offers a convenient and portable storage option to prevent data loss in case of network disconnection. Together with PoE, QoS, time-shift streaming, and enhanced data security HT-TPS encryption and 802.1X authentication, the IP8151 is a top choice for reliable and high performance surveillance.

Security, Hall 7, Stand 625

## ► CONTACT

Vivotek Inc., Chung-Ho, Taiwan  
Tel.: +886 2 8245 5282 · Fax: +886 2 8245 5532  
sales@vivotek.com · www.vivotek.com



### Video Management

Iqinvision announced both the expansion of their popular Iqeye Sentinel Series and the introduction of Iqentry Video Management Software. The all-weather, vandal-resistant Series now includes HD1080p H.264 models. In addition to the current 1.3MP 2.0MP, 3.1MP and 5.0MP options, the HD1080p models produce high-definition video, requiring less bandwidth and storage, while delivering full resolution at max frame rate. The company also introduced Iqentry Video Management Software. This easy-to-install, user-friendly software works with all Iqeye cameras to record, manage, and export video and snapshots. This full-featured software includes camera auto-find, simple set-up and configuration, full-time or on-motion recording, and easy search and playback functionality.



[www.iqeye.com](http://www.iqeye.com)  
Security, Hall 7, Stand 308

### Configuration Wizard

**BUSINESS PARTNER** With the Videonetbox Dallmeier presents an extremely compact and versatile video recording server. The highlight on [www.videonetbox.com](http://www.videonetbox.com) is the Myvideonetbox configurator. Using the configurator fans can configure their very own VNB, according to their requirements. No matter if it is analogue or IP cameras, or whether they are fitted with hard drives or any other useful features. In just a few easy steps the company presents the available options and explains which of them are suited best for what kinds of applications. Suitable accessories are also offered. Moreover, with only one mouse click, customers can request an individual offer directly from the manufacturer.



[info@videonetbox.com](mailto:info@videonetbox.com)  
Security, Hall 3, Stand 805

### H.264 Network Dome Camera

The SNP-3370 high-resolution network PTZ dome camera, which is part of the Samsung Ipolis range, is equipped with a powerful 37x optical zoom which captures high resolution 550TVL images to allow operators to observe the detail of far away objects. At the same time the company has also launched the SNP-3301, which has a 30x zoom capability and shares the same features as the SNP-3370. Both the SNP-3370 and the SNP-3301 have an H.264/MPEG-4/JPEG multi-codec, providing the ability to simultaneously transmit up to six different streams of images to multiple locations at various frame rates, including real time, at different resolutions. Also included in the long list of features incorporated into the SNP-3370 and the SNP-3301 is Samsung's Intelligent Motion Detection in Speed technology which overcomes the challenge of utilizing motion detection when a dome is on the move. This technology analyzes successive frames of video at preset locations within a sequence and when motion is detected, the camera pauses on the preset until the motion ceases. During this time a "D" is displayed on screen and an alarm output is triggered with the option to send an e-mail alert.



[stsecurity@samsung.com](mailto:stsecurity@samsung.com)  
Security, Hall 2, Stand 413

### Ethernet Transmission Equipment

Comnet is introducing a new line of cost-effective Ethernet transmission equipment under the Comworx Value Line label. This Ethernet line is designed for non-hardened environments.



It consists of managed Ethernet switches and media converters. At the top of the line there is a modular 24 port managed Ethernet switch that allows users to select from individual 8-port expansion modules offering a selection of electrical, optical and SFP ports. The line continues with cost effective 8 and 9 port managed switches that offer Fast and Gigabit Ethernet connectivity with electrical and optical ports in different combinations. As one of the first in the industry, the company is launching industrial media converters with built-in power over Ethernet+ (IEEE 802.3at PoE+) functionality and multiple DC input voltages (12/24/48 VDC) as well as several Ethernet over coax and twisted pair VDSL2 products.

[info@comnet.de](mailto:info@comnet.de)  
Security, Hall 3, Stand 502E

### IP and Dome Cameras

Basler Vision Technologies has introduced its new generation of light-sensitive IP cameras. They are equipped with the best CCD sensors and provide frame rates of up to 100 fps. Another highlight in the company's portfolio are the IP Fixed Dome Cameras with a micro SDHC card slot. This feature lets the camera act as a self-sufficient system by writing all alarm images to an SD card with a capacity of up to 32 GB. With their vandal-resistant aluminum housings, the manufacturer's IP Fixed Dome Cameras support video surveillance applications requiring an operating temperature range from -35 °C to +50 °C (-31 °F to +122 °F). The cameras are especially energy efficient. All functions, including fan and heater, can be powered using standard PoE (IEEE 802.3af Class 0).



[www.basler-ipcam.com](http://www.basler-ipcam.com)  
Security, Hall 2, Stand 209

### HD-capable Hard Disk Calculator

**BUSINESS PARTNER** With the HDD calculator Dallmeier provides partners and customers with a useful and valuable planning tool; The hard disk calculator makes it easy to determine the required hard disk capacity for the manufacturer's recorders. Upon entering the relevant parameters, such as type and number of cameras or the desired resolution and frame rate, the HDD calculator automatically works out the necessary storage capacity. As from the new version 2.0.0 the system is now also HD-capable. Therefore, also high-definition cameras can be included in the calculations.

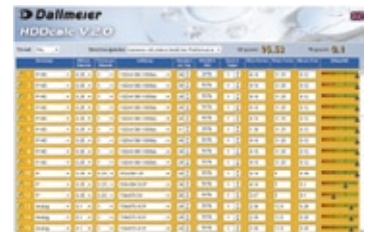

[info@dallmeier.com](mailto:info@dallmeier.com)  
Security, Hall 3, Stand 805

### Offline Readers

Salto Systems announces that its Salto offline access control readers now integrate with Siemens' Sipass integrated security management system. The combined solution offers customers the opportunity to control access to doors using Salto's extensive range of powerful offline solutions – together with Siemens' world-leading online access control system Sipass integrated – all with the same card. All the cardholder data for both systems is stored in the integrated database and all events at all doors – both offline and online – appear in the integrated event log. A Salto offline system can manage an unlimited number of users and doors in a single system, securely controlling who has access to what, where and when at all times. Sipass integrated is a powerful and almost infinitely flexible access control system that is designed to meet access control needs that range in complexity from medium to very high.

[info@saltosystems.com](mailto:info@saltosystems.com)  
Security, Hall 12, Stand 106



**Far Away – Fine Detail**

Samsung has introduced the SCP series of speed domes, a new high specification range with up to 43x optical zoom capability to allow users to monitor a wide area and if required, zoom in on far away objects to observe them in fine detail. The series incorporates the company's A1 DSP chipset that enables the capture of clear and vivid color images at 600 TV lines resolution. There are a total of eleven models in the SCP true day/night speed dome series, four of which offer 43x optical zoom, four with 25x optical zoom and there are also three compact models with 12x optical zoom. There is a choice of internal and external versions with the top of the range models featuring Wide Dynamic Range, which compensates for backlight problems 160 times more effectively than standard BLC, as well as an in-built scheduler which allows the pre-programming up to six separate timed actions each day.



stesecurity@samsung.com  
**Security, Hall 2, Stand 413**

**Nedap launches Aeos 3.0 at Security Essen**

At Security Essen, Nedap Security Management will launch Aeos 3.0 with a completely revised graphical user interface for the intuitive and user-friendly operation. The company will also present Aeos IP Video Management, a truly native video integration, which goes technologically well beyond existing DVR and even open platform-based solutions. Live and stored video images can be viewed by means of Aeos faces, part of the Aeos front end suite, while offering complete freedom of camera choice and storage media based upon industry standards. Moreover, images can be stored on an AEPU (controller) attached hard drive, which significantly reduces bandwidth, and network load issues. Furthermore, Security Essen will be the opportunity to get to know Aeos Locker Management, the perfect tool to enable administrators to authorize carriers to claim any randomly available locker. With this feature it is now possible for a person to claim any free locker by presenting his access badge at the locker's Nedap lock, which supports Mifare Desfire technology, amongst others. The dynamic locker functionality makes locker management more efficient and flexible and is ideal for flex work environments.

ilse.peters@nedap.com  
**Security, Hall 3, Stand 612**

**Visit GIT SECURITY  
 Hall 2 · Stand 506**

**Mechanical and Electronic Security Technology**

**BUSINESS PARTNER** Abus, Abus Security Center and Abus Pfaffenhain will be jointly presenting their entire range of mechanical and electronic security technology at Security Essen. The companies will showcase

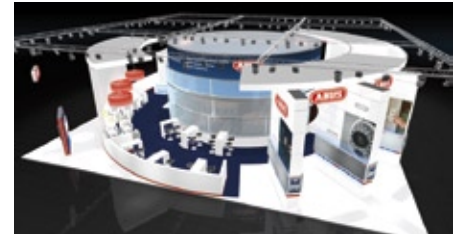

new convergent products combining mechanics and electronics and present new alarm and video monitoring solutions for the home and small and medium-sized companies. A new round stand design reflects the theme of the trade fair, namely an overview of all the latest developments and innovations in the security sector. Over 70 technology professionals, customer advisers and experts from Sales and Product Marketing will present a large variety of innovative products. Abus Security Center is targeting private households in particular – with new products such as the Secvest IP wireless alarm system or the Eycasa product range. These IP video and alarm solutions stand out from other solutions, especially thanks to the flexible manner in which they can be combined and their ease of use. A Video Campaign will also be continued; The company will present new analogue and IP dome camera ranges for internal and external use, and innovative IP video recording systems. "For us, Security Essen is the absolute highlight of the year," explains Marketing Director Michael Zabler. "We expect our developments in the field of mechatronics in particular will be well received." Abus focuses on the combination of mechanical and electronic product lines. Hence at the trade fair it will be presenting mechanical products that can be easily integrated into electronic systems. Moreover, the company is introducing a completely new product range. Marketing and Public Relations Michael Bräuer: "Security Essen is now the leading trade fair for the Abus Group. A particular strength of the trade fair lies in its internationality. Our customers appreciate this and use it as a platform to learn about our brand-new products and market opportunities."

info.de@abus-sc.com  
**Security, Hall 1, Stand 108**

“With Avigilon, we can strengthen security, improve operational flow, and reduce costs for better overall operational performance.”

Michael Howarth  
 IT Infrastructure Manager  
 Associated British Ports



The World's First Open  
**HD Surveillance Platform**

[www.avigilon.com](http://www.avigilon.com)



**AVIGILON**  
 THE BEST EVIDENCE™

### Remote Cleaning Option

With its IP66-weatherproof and V4A-corrosion resistant housing, its dirt and water repellent window and its maintenance-free drive system, Argus, Geutebrueck's high speed, precision pan and tilt system is designed for high performance and reliable operation in inaccessible and inhospitable environments. To deal with any tenacious water drops, snowflakes, insects or spiders, which cling to the front glass and obscure visual detail, the company is now offering its "Airblastcleaner". This is a maintenance-free device, which can be fitted to new and existing units to enable the control room operator to clean the front glass with a short blast of compressed air, without leaving his seat.



carmen.lahr@geutebrueck.com  
**Security, Hall 2, Stand 409**

### H.264 Network and Hybrid Video Recorders

**BUSINESSPARTNER** Bosch Security Systems is introducing a new series of IP only and hybrid (IP plus analog) digital video recorders offering enhanced functionality and easier setting up and operation. The Network Recorder 700 Series is based on a completely new all-IP platform that supports up to 32 IP cameras. The Hybrid Recorder 700 Series is an updated version of the manufacturer's hybrid platform (embodied in the company's Divar XF Hybrid recorder). It supports up to 16 IP cameras and 16 analog cameras. Both 700 Series recorders offer real-time recording and playback in full 4CIF resolution and feature Bosch's advanced H.264 compression technology. The recorders offer a very convenient out-of-the-box solution for setting up medium- to larger-scale video surveillance networks without the need of a PC. Everything can be done via the local user interface, which includes a user-friendly configuration tool embodying automatic H.264 device assignment. This allows a complete IP system to be set up with very little effort without having to individually address every IP camera in the network.



erika.goerge@de.bosch.com  
**Security, Hall 1, Stand 140C and Hall 3, Stand 409**

### EMEA Vendor No. 2

**BUSINESSPARTNER** The recently published IMS Research report on "CCTV and Video Surveillance Equipment 2010" has reaffirmed Seetec's position as one of the leading vendors of IP Video Management Software. In the 'Software-only Vendors of Open Platform Network Video Management Software (VMS)' category, the company was ranked no. 2 in the EMEA region and is rapidly closing in on the no. 1 position. In the rankings for all Open Platform VMS vendors, including players also offering hardware, the company was ranked no. 3. The report also clearly foresees a macro-shift in favor of hardware independent open platform based VMS in the period between 2009 and 2014. Furthermore, IMS Research expects proprietary VMS solutions to decline significantly in the same period. This solid performance is even more remarkable given the gloomy environment that prevailed in the sector during much of last year due to the global economic crisis. "By entering new markets in Europe and by focusing on developing tailor-made solutions for specific verticals, we have distinguished ourselves as the partner of choice for IP surveillance software," says CEO Rolf Senger.



info@seetec.de  
**Security, Hall 2, Stand 213**

### 3D Virtual Airport

Siemens Building Technologies Division has created a section of its website devoted to integrated airport solutions, including interactive features to enhance the visitor experience, including the first 3D 'augmented reality' feature to be created by Siemens. The pages devoted to the company's airport offering focus on security, comfort and passenger safety, demonstrating the way in which an integrated approach can both deter threats and reliably deal with incidents should they occur. It shows how the manufacturer's Command and Control systems treat the airport as a whole, bringing together intelligent security, fire safety and energy optimization. Energy is a particular focus, as airport operators today are searching for sustainable methods of supplying power to all areas of airport facilities, with the additional benefit of saving energy costs. One of the most innovative features is the introduction of augmented reality, which allows the user to interact through the website and control a 3D virtual airport. The user prints out a simple aircraft icon and places it in front of a webcam to enable control of the on-screen visualization of an airport. Moving the icon allows the user to zoom in and out, rotate the landscape through 360 degrees and to load visual and audio messages, which highlight the different areas of the airport environment and the respective capabilities that the company offers.



marc.vonah@siemens.com  
**Security, Hall 3, Stand 309**

# Pivot3 does more with less.

...saving 40% on rackspace,  
 power and cooling.

Free virtual server  
 for your VMS!



The Pivot3 ScaleOut Application Platform is the first IP SAN Storage solution with integrated server virtualization.

[www.pivot3.com](http://www.pivot3.com)   [sales@pivot3.com](mailto:sales@pivot3.com)





## Onvif Compliant Dome Cameras



**BUSINESSPARTNER** Bosch Security Systems is extending its IP Camera 200 Series with Onvif (Open Network Video Interface Forum) compliant compact dome cameras. Compliance with the new standard means the series offers full compatibility with other Onvif surveillance products, providing users with greater freedom in specifying a system and helping them save on future upgrades or migration costs. The series, which now includes four models, is easy to install and operate. Each camera comes with a Secure Digital (SD) flash memory card for storing days of recorded video without a connected PC. No technical expertise is required to set-up the cameras, customers simply insert the SD card, plug in the camera, and viewing and recording starts immediately. A single cable connection provides Power-over-Ethernet and handles viewing and recorded video. No additional equipment is required. The solution can also be easily extended by connecting a video recorder, such as the Bosch Divar 700 Series or an iSCSI server. Moreover, efficient H.264 image compression reduces the requirements for storage by up to 30 percent compared with traditional surveillance technology – an important cost-saving feature. [erika.goerge@de.bosch.com](mailto:erika.goerge@de.bosch.com)

**Security, Hall 1, Stand 140C and Hall 3, Stand 409**

## Solutions for IP-based Video Surveillance

**BUSINESSPARTNER** Eneo is presenting itself at the Security in Essen as a provider of professional IP-based video surveillance. The center stage is occupied by the Zelaris Management Software for bringing all video signals from well-known IP suppliers to an easy-to-use, intuitive user interface. Numerous functions such as OPC connection and analysis tools make it powerful solution. For less demanding tasks, the company's Nimra and ONVIF-capable Numina freeware solutions are available – shipped with all N Series IP products. Additionally, VPT Series Pan/Tilt Heads now feature network control. Nearly all the IP products support the Onvif standard so that they work together with products from other suppliers. For analogue applications the VKC(D)-1375 Camera and Dome is a suitable choice – their numerous analysis functions support automated surveillance.



[www.videor.com](http://www.videor.com)  
**Security, Hall 2, Stand 507**

## HD-CCTV-Surveillance

**BUSINESSPARTNER** Everfocus Electronics Corporation has launched a HD-CCTV surveillance system, which uses the latest High Definition Serial Digital Interface (HD-SDI) technology, delivering real-time 1,080 HD resolution images over standard RG59 coaxial cable. The company predicts it will be the first in the UK to offer a HD-CCTV 'plug and play' system with a two megapixel HD-CCTV camera and an eight channel HD-CCTV embedded digital video recorder (DVR), when it ships this system during Quarter 4 2010. The EQH5200 is a two megapixel camera using a 1/2.5 inch CMOS sensor to deliver a choice of HD-CCTV resolutions (720p/1,080i). Designed for indoor use, the EQH5200 has a compact box design and offers day/night functionality. Set-up is simple with an RCA TV output for installation use and an on-screen set-up menu. This camera is simply connected to a coaxial cable network using a standard BNC connector. With eight BNC video inputs for coaxial connections, the EHDR08 true HD-CCTV eight channel DVR offers either 720p/1,080p HD resolution recording using H.264 compression, with four slots for hard disk drives offering a current maximum internal data storage capacity of 8 terabytes. Video output can be via VGA or HDMI. The DVR makes video viewing, recording and searching simple and incorporates Express Search, Snapshot and Smart Search functionality, with three USB ports and a built-in DVD burner for quick video file transfer. It also includes a Gigabit Ethernet interface for remote network viewing and management, plus support for 3GPP mobile monitoring.

[info@everfocus.de](mailto:info@everfocus.de)  
**Security, Hall 5, Stand B5**

## Enhanced Security Management Platform

Nedap Security Management has released Aeos 2.4., which comes with IP video, locker management and key cabinet functionality. It enhances the security management platform in which multiple security disciplines are combined on one single controller and one server environment. Aeos IP video management is a truly native video integration, which goes technologically well beyond existing DVR and even open platform-based solutions. Live and stored video images can be viewed by means of Aeos faces, part of the Aeos front-end suite, while offering complete freedom of camera choice and storage media based upon industry standards. Moreover, images can be stored on an AEPU (controller) attached hard drive, which significantly reduces bandwidth and network load issues. Tens of thousands of lockers have been equipped with the manufacturer's locker management over the last decade. This technology now becomes available in Aeos. Aeos locker management enables administrators to authorize carriers to claim any randomly available locker. It is now possible for a person to claim any free locker by presenting his access badge right at the Nedap locker lock, which supports amongst others, Mifare DESfire technology. The dynamic locker functionality makes locker management more efficient and flexible and is ideal for flex work environments.

[ilse.peters@nedap.com](mailto:ilse.peters@nedap.com)  
**Security, Hall 3, Stand 612**

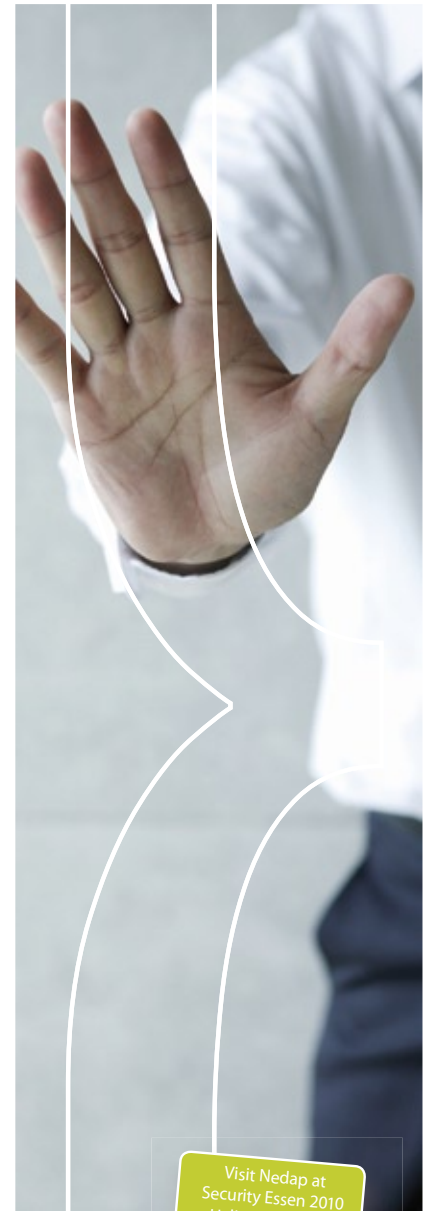

Visit Nedap at  
Security Essen 2010  
Hall 3, Stand 612

# when security matters

When the security of your company matters, only a lifetime security solution with unlimited possibilities and an unequalled return on investment is good enough. By choosing Nedap AEOS that's exactly what you get! With AEOS you're always one step ahead of the ever-changing security standards.



For more information: Nedap Security Management  
+31 (0)544 471 111 - [info@nedap-securitymanagement.com](mailto:info@nedap-securitymanagement.com)  
[www.nedap-securitymanagement.com](http://www.nedap-securitymanagement.com)

## SECURITY ESSEN

# Total Security Solution Capability

**Visitors to the Samsung Stand at this year's Security Essen will have the opportunity to see the latest Samsung security products in the 2010 line-up, including new CCTV, IP, access control, video door phone and intruder detection ranges which can be used together to create a total security solution.**

"Security Essen will provide us with a great opportunity to demonstrate our latest products to our growing European customer base," said James Smith, European Marketing Manager for Samsung Techwin Europe Ltd. "Samsung is continuing to evolve at pace into a full security solutions provider and our stand will fully reflect this with products and technologies from various disciplines integrating together to bring real benefits to the end-user."

Available for full demonstration will be the latest Samsung cameras and domes featuring next generation DSP chipsets showing how enhanced resolution, leading low-light technology and built-in video analytics can bring major benefits to security installations both over analogue and IP networks. In addition, Samsung will be demonstrating its latest ranges of H.264 com-

pression digital video recorders and network video recorders which provide a fully scalable solution for virtually any recording requirement.

Also on show will be Samsung's comprehensive new range of RFID and Biometric technology based access control systems, which provide a cost effective solution for anything from a stand-alone single door solution through to large or multi-sited applications, whilst Samsung's ultra-stylish video door phones offer visual and voice confirmation for single and multi-door commercial and residential properties.

Aside from this the very latest speed dome, thermal, Centralized Management Software and energy saving LCD monitor ranges will be on display.

Security, Hall 2, Stand 213

## ► CONTACT

Samsung Techwin Europe, Chertsey, UK  
Tel.: +44 1932 455 308 · Fax: +44 1932 455 325  
STESecurity@samsung.com · www.samsungcctv.com



## SECURITY ESSEN

# Security for People, Processes and Assets

**Security and fire safety solutions take center stage on the Siemens stand at Security 2010 in Essen: with Siveillance Fusion, Siemens will present an integrated security management system, which offers a centralized view and control of access control, intrusion detection, and video surveillance. Siveillance Fusion is an IT based system with open standards, providing both modularity and flexibility.**

## Open and Flexible Security Solutions

Siveillance Fusion combines access control, video surveillance and intrusion detection in a single security management system, providing complete control and overview of a corporation's physical security operations. Siveillance Fusion is an IT based system working with open standards such as ONVIF (Open Network Video

Interface Forum). By being an ONVIF conformant management station customers are given the freedom of choice in selecting field level components such as cameras and encoders.

With Siveillance Netwatch, Siemens presents an application for the converging physical and IT security sectors: the platform enables the systematic monitoring of selected IT components and their performance, and creates alarms, which are displayed and handled via the security management systems should something be suspicious, providing a complete security view including components performance in real time.

## Innovative and Industry-specific Fire Safety Solutions

In the fire safety field, Siemens will present new developments in the Sinteso fire protection portfolio as part of a „Life Safety“ concept which considerably improves human protection. The information provided at the Siemens stand is com-

pleted by market-specific solutions and innovations. At the heart of the „Life Safety“ concept is the Sinteso FDOOTC241 fire and gas detector that not only provides reliable fire detection, but also triggers an alarm when potentially harmful CO concentrations are detected in the ambient air. Further „Life Safety“ features relating to the Sinteso fire detectors, control units and FDnet devices include an emergency mode – ensuring reliable signal transmission even in the event of a control unit malfunction – a standby mode and integrated turbo isolators.

Security, Hall 3, Stand 309

## ► CONTACT

Siemens Building Technologies Division,  
Zug, Switzerland  
Tel.: +41 417244377 · Fax: +41 417234756  
www.siemens.com/buildingtechnologies



## PERIMETER PROTECTION

# Right at the Edge

## Applying Sensor Cable Perimeter Protection and Intruder Detection Technology

**The Italian manufacturer of outdoor security products Sicurit has extended its already comprehensive product range with the addition of the Sicurflex sensor cable product. Perhaps sometimes overseen as being too primitive for high-security sites, this technology can in fact be either a sole boundary deterrent and detection system but also represent one additional element of a total security concept.**

A glance at the company's website shows that this well-established security systems manufacturer takes its responsibilities seriously. It is not only continuously developing its own products but also researching new opportunities to improve well-known technology solutions. The Sicurit infrared and microwave detectors have already found frequent application in government administration and correctional institutes, financial and pharmaceutical properties, manufacturing plants, airports and even nuclear power plants around the world. The innovative combination of these technologies in the dual-technology columns has been featured here in GIT SECURITY. But these 'high-end' products do not always fit within the available budget and it is good to know that Sicurit do not ignore the simpler and more economic solutions that are available for boundary protection.

The new Sicurflex perimeter protection system provides a reliable and cost-effective solution for protecting properties from unauthorized intrusion. Developed also to meet the recent increased demand for cost-effective solutions for the protection of solar parks as well as photovoltaic frames, the equipment can be utilized in many other different applications and can be installed on any type of boundary fence available on the market. Indeed, apart from being a designed-in component of new fences, it can also be quickly and easily fitted to existing fences to add an extra layer of security to already operational systems.

### Whatever the Weather

The Sicurflex system operates by means of an 8 mm diameter sensor cable that is mounted all the way along a perimeter fence. An electrical signal



that is generated in response to movement or deformation of the cable will, within the desired threshold level, trigger an alarm condition. This simple but foolproof technology is pretty much immune to a lot of the environmental elements that disturb other more refined detection systems. It really doesn't matter if snow is falling, if there's a sandstorm or even thick fog blocking the view; any out of range movement of the fence will cause the system to close the dry alarm contacts.

It will operate reliably at temperatures as low as -20 °C and as high as +50 °C, making it suitable for installation in almost any region in the world. The IP65-rated FLCEN control unit housing for a 500 m length of cable only weighs around 300 g and consumes a measly 5 mA of power at 12 VDC. This represents truly low cost of operation. Of course, the maintenance effort required for such a simple and effective solution is also extremely low.

### No Way Through

Choosing a sensor cable over other types of security device can provide a cost-effective solution where the installation of other technologies proves to be difficult or even impossible, for whatever technical or operational reasons. Nevertheless, a high detection capability is still ensured by the ability to 'tune' the sensitivity of the system according to the actual conditions found on that particular site.

The temptation for any intruders reading this article to try to either cut the cable, bypass it or make a short-circuit should be forgotten as such conditions will immediately be detected and the separate tamper alarm raised on a dry relay contact. It is, however, possible to set up non-sensitive zones where these are specifically required as part of the cable run, for example going past a manned security gate or the fence support pillars. This is achieved by building 'bridges' using the FlexCN junction unit and RG59 cable. This topology can also be very usefully applied to run sensor cable along the edges of and in between expensive solar panels, ensuring that each and every one stays exactly where it was installed.

During planning and installation, the system elements are chosen to match the layout of the boundary fence to be protected. The resultant system layout provides reliable detection of attempts to either surmount or to cut through the perimeter protection, or to otherwise tamper with it. This is yet another tool that can be effectively used to provide peace of mind, both for the owners of the protected object and also for the responsible security manager.

### ► CONTACT

Sicurit Alarmitalia Spa  
Milan, Italy

Tel.: +39 0238 0701 · Fax: +39 0230 88067  
export@sicurit.it · www.sicurit.net

## In Focus: Basler BIP-D1300

In May this year, Basler extended its range with new IP fixed dome camera models. The models BIP-D1000c-dn with a resolution of 1024 x 769 pixels, and the BIP-D1300c-dn with a resolution of 1280 x 960 pixels are now available. Because of their impact-resistant aluminium casing and possible operating temperatures from -35° C to +50 °C these cameras are suitable for video surveillance outdoors and for inside use under extreme conditions. The dome cameras provide the same functionalities as the corresponding camera modes without a dome housing: Day/night functionality for night use and applications in difficult lighting conditions. The Sony CCD sensors should ensure excellent image quality in all lighting situations. Basler IP fixed dome cameras are equipped with a microSDHC slot to store data locally and can be run with Power over Ethernet (IEEE 802.3af Class 0). The manufacturer specifies multi-streaming with several independent MJPEG streams or several MJPEG streams and an additional H.264 or MPEG-4 stream.



CAMERA TEST

# Test the Best!

## GIT SECURITY Camera Test in Cooperation with SeeTec



**In cooperation with Seetec, GIT SECURITY tests current and new video cameras under standardised conditions in the test laboratory of the SeeTec Hardware Competence Center. The Hardware Competence Center was set up because the data and performance specifications of network cameras as stated by manufacturers are often measured under different conditions and are not always reliable in practice. The results provided a sound basis for planning IP video projects and help to avoid unpleasant surprises. For the testing procedure, video sequences are produced under defined lighting scenarios and are then evaluated. Here, movements in the picture as well as night and backlight situations are taken into consideration.**

### Performance

#### Performance assessment when used with 1,000 Lux

In the test, the image from the camera was balanced, with clear and largely correct colours. The saturation and contrast were also good. Moving and stationary objects were depicted sharply in the test image.

#### Performance assessment when used with less than 1,000 Lux

Even in poor lighting conditions, the camera produced a good image with clean reproduction of colours. In the test sequence, rapid compensation characteristics on changes in the lighting level were already noticeable. Below 20 Lux, a spearing effect was observed with moving objects, which increased as the illumination level reduced. At 0.5 Lux, the automatic day/night switchover changed to b/w mode.

#### Performance assessment in backlight situations

In the test, the camera reacted well to glare situations and compensated quickly (< 2 seconds). Even with strong backlight, details in the background of the image were still recognisable. However, due to the CCD sensor used, a smearing effect was observed and a blooming of the light source bay two to three times was observed.

#### Performance assessment in use: Bandwidth measurement

The measurement was made with MJPEG at maximum resolution and 11 images per second, as at full resolution, H.264 only provides 7 images per second. The bandwidth used was an average of 7.24 MBit/sec and with reducing illumination fell to approx. 4.7 MBit/sec at 0 Lux. With backlight, a maximum of 9,39 MBit/sec was achieved.

\*Average value.

### Technical data for the camera test

Manufacturer	Basler
Model	BIP-D1300
Firmware version	2.0
Distance from test chart	0.60 m
Lens used	2.8 - 6mm, F1.3, DC
*Focal length set	approx. 6 mm
*Compression method	MJPEG
*Resolution	1280 x 960
*Compression	50 %
Max. stream bandwidth	Unlimited
Measured frame rate	11 fps
Average bandwidth	7.24 Mbit/s

\*The camera was integrated into the test system with the "default" settings. The settings were modified according to the test criteria listed above.

### Assessment for various lighting conditions

Criteria   Lux values	1,000 Lux	100 Lux	10 Lux	0.5 Lux	0 Lux + *BL1
Colours	2.5	2.5	2.5	s/w	s/w
Contrast	2	2	2.5	3.5	s/w
Sharpness	2	2	2	3	2.5
Motion blur	2	2	2.5	3	2.5
Image noise	2	2	2	4	2
Compensation time with backlight	-	-	-	-	3
Behaviour with backlight	-	-	-	-	4

Assessment was performed according to the rating system of 1 (very good) to 6 (unsatisfactory). By setting various parameters on the camera interface itself, it is possible to obtain an improved image quality.

### Conclusion

In the test, the vandal-proof dome camera with outdoor capability and day/night switchover delivered a good image even under poor lighting conditions. It especially shows its strengths in backlight situations. It is therefore particularly suitable use for access areas or in a logistics environment. The camera receives its power supply via PoE. It supports MJPEG, MPEG4 and H.264 and is equipped with an internal SDHC slot.





**BUYERS GUIDE** **LEAD GENERATION**  
**EVENTS** **REPORTS** **NETWORKING**  
**INDUSTRY NEWS** **WEBINARS** **ONLINE-ARCHIVE**  
**TREND TOPICS**  
**IT SECURITY SECURITY** **FIRE PROTECTION** **SAFETY MANAGEMENT** **JOB**  
**WHITEPAPER** **RSS FEED** **PRODUCT INFORMATIONS** **WEBCASTS**

**GIT-SECURITY.COM**

➤ **GIT SECURITY,**  
the leading EMEA print and online media for safety and security

➤ In cooperation with **PRO-4-PRO.com** we present:

- **Buyers Guide**
- **Webcasts**
- **Webinars**
- **Jobs**
- **Online Surveys**
- **Newsletter**
- **Enhanced Search Functions**
- **English Language**

**[www.git-security.com](http://www.git-security.com)**



CGTV

# Back on the Rails

## Metro Durban Rail Makes Railway Stations More Secure with Modern CCTV

A lot has happened as a result of the Fifa football world cup in South Africa. But the country at the southern-most point of the black continent is still plagued by a high rate of crime, above all in the large cities and their suburbs. It is unfortunately impossible to exclude the possibility that one will be the victim of a robbery, theft or violence. But a few things have actually been done to improve safety for all – for example in Durban, where a CCTV system from Sony has been doing stalwart service for some time now. GIT SECURITY had the opportunity to interview the planners and installers of the project, the security officers in charge for the system's maintenance, and the Head of Security of Metro Durban Rail exclusively for our readers and to look more closely at all the security measures of this urban transport service provider.



Durban in South Africa: blossoming city and FIFA world cup venue 2010



Planners, installers, experts (from left to right): Simon Nash (Sony), Kiren Govender, Kevin Chetty, Indran Govender (all KgT Enterprises) and Edward Nyingeni (Sony)





The control room: Project Manager Desan Govender and Indran Govender from KgT



Monty Makhallima, Project Manager (left) and Ivan Chami, Risk Manager for PRASA in the KZN Province of South Africa

Durban – or in Zulu language: eThekweni – is the largest city in the province of KwaZulu-Natal and the third largest city in South Africa, forming part of the eThekweni metropolitan municipality. Durban is famous as the busiest port in South Africa and is also a major center of tourism because of the city's warm subtropical climate and extensive beaches.

### Blossoming City and World Cup Venue

The city has a population of about 3.5 million, making Durban the biggest city on the east coast of the African continent. Today, Durban is also the busiest container port in Africa, and a popular tourist destination. The city is also a gateway to the national parks and historic sites of Zululand and the Drakensberg. Good news: there has also been growth in the number of jobs provided by the Durban Metropolitan Area (DMA) formal sector over the past 20 years. High rates of crime had become a disincentive to even more growth in tourism and many other sectors but, directly as a result of the FIFA World Cup, Durban has made significant investments in security and specifically for the public rail transport system.

### Reducing Crime

Of course the local rail transport operators wanted to do something to improve security. "Metrorail" operates the rail service in Durban and the surrounding area and its network runs from Durban Station outwards as far as Stanger

on the north coast, Kelso on the south coast, and Cato Ridge inland. GIT SECURITY was given the opportunity to study the CCTV system more closely and it really is a first-class system that helps to significantly lower the crime rate at an important trouble spot.

The most important aspects first: the individual railway stations have been networked, events can now be centrally managed and corresponding security measures organized quickly. To achieve this, 101 cameras have been installed and a further 130 will follow. Kiren Govender's company KgT Enterprises is an integrated, turn-key solution provider for access control, intrusion detection, fire detection, CCTV and digital recording. As overall planner for all local security measures, he has already done a lot of work and, together with the Metro operators, has ensured that really all areas are well monitored and secure. "We love the pictures of those cameras", was Kiren's statement, as we took a walk together through the Metro passages and inspected the systems that have been installed on the platforms. "They show us all the right details in all situations; we can react at once and thereby provide much better security", adds Durban Rail's security consultant Desan Govender. Anyway, before installation of the new cameras there were always thefts happening, and that even included a lot of property of the railway system itself. They didn't even stop at removing parts of the rails. "After installing the cameras, the rate of criminal events sank by a massive 45%", explains Ivan Chami, the local Area Security Commander at Metro Durban Rail.

Monty Makhallima is responsible for the Metro Durban Rail Maintenance. He is also visibly satisfied with the equipment that the system integrator has made available to him. The maintenance effort required is low; the Sony cams function without problems. "At the end of the day, we had to find a solution together with our planners and the installer that fitted into our financial budget, but simultaneously delivered good quality", explained the Security Commander Chami. Desan the planned added: "Whereby we also learned that video security is more than just having more mega pixels – it is: good quality. And one can see that in every single camera, in the pictures and the information on the monitor."

### Systems in Use

As well as other security tools that provide fire protection and security, the planners also installed and set up the following CCTV products from Sony:

The Sony SNC-CH140 HD is a fixed network camera and it delivers excellent picture quality at HD resolution (1280 x 720, 30 fps) in 16:9 aspect ratio. This level of clarity combined with state-of-the-art image processing make the CH140 one of the most effective CCTV cameras on the market. The capability makes it an obvious choice for mission critical CCTV applications

JOB

detectomat®

**Schnell und zuverlässig**  
Fast and reliable



security  
Halle 3.0  
Stand 707

**Technologien von detectomat**  
Technologies from detectomat

**detectomat GmbH**  
An der Strusbek 5  
22926 Ahrensburg  
Germany

Tel.: +49 (0) 4102 – 2114 – 60  
Fax: +49 (0) 4102 – 2114 – 670  
E-Mail: info@detectomat.com  
Web: www.detectomat.com



Durban Metro Rail: on of the station platforms



More secure with modern CCTV: Metro Durban Rail station

including airport, border and traffic surveillance like this at Metro Durban Rail.

"Of course it is important that the systems can be easily installed and operated. That is the case with these Sony cams", says Monty Makhalima. And it's true: installation of the CH140 is quick and easy, thanks to the Easy Focus function which automatically adjusts to the native surroundings. PoE (Power over Ethernet) capability and support for multiple codecs provide ultimate flexibility for system design, integration and installation. The 71 SNC-CH140 units installed at Metro Durban Rail also feature ONVIF (Open Network Video Interface Forum) compliance for easy interoperability with IP monitoring products from a variety of manufacturers.

The network mini-dome camera SNC-DF50P is a powerful yet compact network camera and it supports an efficient and intelligent processing method called intelligent video analytics. "Exactly what we need", says Desan Govender. The 26 units installed in Durban automatically de-

termine when an image should be recorded or an alarm should be triggered. Coupled with this intelligence, the camera delivers a dramatic improvement in dynamic range (128 times that of a conventional camera) thanks to Sony-unique DynaView technology. This makes the camera ideal in extremely high-contrast environments. Designed for indoor use, its clever design saves time and effort at installation, and gives true location flexibility.

Also the SNC-DH140 HD mini-dome network camera delivers excellent picture quality at HD resolution (1,280 x 720, 30 fps) in 16:9 aspect ratio. Like the SNC-CH140, also this camera is a good choice for mission critical CCTV applications. The 2 DH140 Metro cameras also have an Easy Zoom function to adjust the focus relative to the zoom ratio. Moreover this mini-dome also features ONVIF compliance for easy interoperability.

The two high-performance SNC-RX570 network cameras with 360 degree endless rotation are the flagship network cameras at Metro Durban

and they come with several advanced features. For example, they are particularly suited for use in high-contrast environments thanks to Sony's DynaView technology, which helps to reproduce clear and accurate images no matter what the lighting conditions. Naturally the very different light conditions occurring on a platform have to be considered. They also feature a new digital signal processing unit for enhanced picture quality and has an amazing 36x optical zoom, providing a maximum 432x zoom when combined with the 12x digital zoom. All SNC-RX Series Network Dome Cameras feature built-in intelligent object detection and intelligent motion detection. They can also freely and endlessly rotate 360 degrees, allowing users to monitor the area surrounding the camera without interruption. Advanced image processing technology offers a choice of three compression formats – JPEG, MPEG-4, and H.264 – so that users can choose the appropriate format to match their network environment and monitoring applications. A newly-developed "dual encoding capability" also allows simultaneous streaming in JPEG and MPEG-4, further improving workflow flexibility. Designed for 24/7 operation, the RX Series incorporates a Day/Night function, providing clear images even in 0.15 lx lighting conditions. The SNC-RX series is the right choice for a wide variety of surveillance and monitoring applications, delivering efficient 24/7 monitoring – anytime, anywhere, anyplace. Also at Metro Durban Rail.

### Summary

For the Fifa World Cup, the main stations and some sub-stations of Durban Metro Rail were equipped first of all. Further work to complete the project is being done step-by-step so that finally 130 railway stations will be networked with one another and well secured. This represents a further contribution towards improved security in South Africa and specifically in Durban. For now, they can be satisfied, particularly that that everything is working as planned.

Ivan Chami even added: "The results that the new system delivers have far exceeded all our expectations." That's not really a surprise with such a successful start: on the day of completion of the project two rail fetishists were pulled off the track and arrested.

### ► CONTACT

#### Kiren Govender

KgT Enterprises, Midrand, South Africa  
Tel.: +27 11 315 88 99 · Fax: +27 88 011 315 0201  
k.g.govender@kgjenterprises.co.za  
www.kgjenterprises.co.za

#### Simon Nash

Sony Broadcast & Prof. Europe,  
Basingstoke, United Kingdom  
Tel.: +44 1256 355011 · Fax: +44 1256 811110  
simon.nash@eu.sony.com · www.sony-cctv.com



## CCTV

# Pilot of the Railways

## Finnish Rail Chooses IndigoVision for Pilot IP-CCTV Project



Helsinki Central Station, where IndigoVision's IP Video solution has provided surveillance for a number of years



Helsinki Central Station

**The Finnish Transport Agency for Rail, Maritime and Road Administration, has announced that the pilot project for evaluating an advanced IP-based surveillance system for 11 train stations, was awarded to IndigoVision's Authorised Finnish Partner, Taitotekniikka (Kauppahuone Taito Oy).**

The pilot project, which started this spring, will cover some 12 sites, of which 11 are rail stations. The Central Station in Helsinki is already using IndigoVision's end-to-end IP Video security solution for its station-wide surveillance. The station's existing CCTV control room will also monitor the 12 sites of the pilot project, through more than 250 new IP cameras. In addition 2 new surveillance centres will be connected to the IP network, creating a distributed and redundant remote monitoring capability for the Central Station and the pilot sites. The pilot project will be rolled out during the summer of 2010.

### **Ambitious Plans for the Future**

The Finnish Transport Agency intends to build one of the world's most advanced distributed IP-

CCTV systems for rail surveillance, where the final goal is to have a nationwide system covering all stations with a network expected to monitor some 5,000 IP cameras in total. The plan is to record video 24/7 from all cameras on to distributed Network Video Recorders (NVRs), fully managed by remote surveillance centres.

IndigoVision's class-leading H.264 compression technology allows high-quality video to be transmitted across long distances with minimum bandwidth and latency. This was regarded as vital for designing the new pilot system. Special software such as Bandwidth Manager and a server-less decentralised configuration of the planned network of 5,000 IP endpoints, will also be key features in building a reliable distributed IP-CCTV system with no single point of failure. The solution will use IndigoVision's advanced features for creating a resilient, fault-tolerant system, allowing the end user to take advantage of redundant networks, redundant power supplies and redundant distributed NVRs.

### **Hundreds of Cameras 24/7**

All cameras on the network will record on a 24/7 basis, using a mixture of IndigoVision's dedicated standalone Linux-based NVRs and PC's running Windows-based NVR software. According

to Taitotekniikka, the number of operators able to see live and recorded video from all of the cameras can be several hundred. The operators will use PC workstations running 'Control Center', IndigoVision's Security Management Software.

The pilot system is designed to handle both Standard Definition (SD) and High Definition (HD) cameras side by side, enabling H.264 and MPEG4-based equipment to coexist on the same network. Future releases of 'Control Center' software will also allow ONVIF-compliant IP cameras to be used at any point on the network.

[Security, Hall 2, Stand 429](#)

### **▶ CONTACT**

IndigoVision  
Tel.: +44 131 475 7200 · Fax: +44 131 475 7201  
info.request@indigovision.com  
www.indigovision.com

CCTV

# Take a Good Look

## Considerations When Planning a Surveillance System



**A burglary takes place and there is a great deal of anger about the resulting damage. Fortunately the premises are equipped with a video system which enables the incident to be analyzed in detail. However, the subsequent viewing of the images causes great disappointment because although the recordings show that a theft occurs, it is impossible to identify the thieves. And this despite the fact that a device was specifically chosen whose recordings were described as being "admissible in courts of law". What does "admissibility in courts" actually mean and what should users take into account?**

Admissibility in courts means that the video recordings are accepted and permitted as evidence in courts of law. The admissibility of recordings as evidence is proven by a certificate which is issued, amongst others, by LGC Forensics, formerly known as Kalagate. They check whether the recorder is protected by encryption technology, which safeguards against remote access to the 'closed' system and prevents any outside manipulation. Additionally, the devices must be designed to be forgery-proof in order to verify

that the images are unedited. In short: it must be certain that the images are not manipulated on the way from the recording device to the courtroom, as could happen for instance when the footage is transferred to storage media such as DVDs.

There are different ways to prevent attempts at manipulation. One practice is to integrate an electronic watermark. This process embeds certain information, so-called watermarks, into the image when it is saved on the recorder. If an attempt is later made to edit or alter the image by

any means, the watermark is automatically deleted. A check whether the watermark still exists is all that needs to be done in order to prove the originality of the images. Confirmation of the usability of the images in courts of law thus only refers to the transfer of the image data from the recorder to the court. It does not, however, say anything about the quality of the images.

### Horses for Courses

It is important to choose the right technology. When deciding to utilize a certain camera, it





should already be considered what the images will be used for. Therefore the question is whether the user wants to notice, detect, recognize or even identify? Noticing means that it can be observed that something is happening. With detection, it is possible to distinguish between humans and animals. Recognition is even more precise: it allows differentiation between a man and a woman. Finally, the most precise level is identification. This means that an operator could clearly state that the camera has captured, for example, Mrs XY.

Such considerations have to be made before the installation of a surveillance system. If it is initially only required to have a broad overview of an extensive car-park, one cannot expect later to be able to identify an individual number plate.

Pixel or resolution error is a common issue, particularly in connection with new HD technology. A high-quality high-definition camera that records in 16:9 image format provides a wider field of view than could be achieved with a conventional SD camera. For example, at a petrol station it might now be possible to view three fuel pumps, whereas before it was only possible to view two. An outstanding depth of field and higher resolution than 4CIF are further benefits that, together with the zoom function, provide corresponding potential.

#### Dotty About You

These are excellent properties for an overview camera. However, they do not work with every kind of application. In order to be able to identify a face, for instance, it must be displayed in the image with a width of at least 150 pixels. This requirement is valid for both standard definition and high definition. Whereas previously similar calculations were made to choose a suitable lens, this approach is frequently neglected with HD technology. This is due to the notion that the zoom functionality could compensate for any shortfalls of the lens. However, at the end of the day, a pixel remains a pixel, and not

even the best zoom in the world can do anything about that. Thus, if the goal is to identify people, it must be ensured that the real pixel size which is needed to identify faces is actually achieved.

Another important point is the fact that an increase in the number of pixels comes at the expense of the camera's light sensitivity. Generally, during night situations a megapixel camera will produce poorer results than an SD camera – smearing effects often appear when there is motion although such effects can be prevented by choosing higher shutter speeds. One should not forget though that this will only help if there is enough ambient light. Light is also an issue to be considered by itself: if the camera is exposed to extreme lighting conditions, such as strong backlight caused by a glass facade for example, it should be ensured that the camera is capable of mastering such conditions. In such cases a high dynamic range is often more important than the number of pixels. It should also be assessed if monitoring from several angles is better than one single wide-angle perspective at HD or megapixel resolution. When installing a video system, the most suitable technology for the respective application should be chosen.

#### Taped Up

Besides selecting the camera, it is of course also important to choose a suitable recording device. Is the recorder capable of recording at a sufficiently high resolution? Does the device operate reliably and offer high failure safety? After all, what would be the point of images being permitted as evidence in court when the recorder fails at the decisive moment?

Even the best technology will be to no avail if it was incorrectly installed in the first place. Obvious really, but often forgotten: if the face of a customer who is paying at the checkout counter is to be recognized, the camera must be installed at an angle that is as low as possible relative to the face. If the camera is mounted in the ceiling, a hat or the hair parting of the customer will be

clearly recognizable. The customer's face though will be not be visible, unless he happens to look directly into the camera.

There is yet another point to be taken into account. The larger the focal distance, the larger the dead angle in front of the camera becomes. In the worst case the dead angle could mean that recordings show that suspicious activity is taking place somewhere at the back. However, at that distance the person can't be identified. As soon as the person comes closer to the camera though they stand within the dead angle of the camera and can no longer be seen at all.

#### Three Golden Rules

These are only two examples of the many errors that unfortunately occur over again in practice. Such errors could be avoided easily by clearly defining what the images will be used for prior to any purchasing decision. There are three crucial points that need to be considered when talking about the usability of video recordings in court. Firstly, the right systems must be chosen. Secondly, these systems need to be correctly installed. And thirdly, there must be evidence that the images are tamper-proof.

New technologies such as megapixel resolution, or high-definition cameras in particular, offer numerous benefits that can however only be realized if the technologies are used correctly. Before a purchasing decision is made, users need to precisely define what should be achieved by the surveillance installation and plan the system accordingly.

Security, Hall 3, Stand 805

#### ► CONTACT

 BUSINESSPARTNER

Dallmeier electronic, Regensburg, Germany  
Tel.: +49 941 8700 0 · Fax: +49 941 8700 180  
info@dallmeier.com · www.dallmeier.com

## Infrared Megapixel lens!

**M13VG288IR**

Sensor size 1/3" Focal length 2,8-8 mm F-stop F/1.2

### MEGAPIXEL RESOLUTION AT IR RANGE

IR CORRECTED UP TO **1000 nm**

HORIZONTAL ANGLE OF VIEW OVER **100°**



Hall No. 2  
Stand No. 109

Tamron Europe GmbH  
Robert Bosch Str. 9  
50769 Köln

phone: +49-(0)221-970325-0  
mail: cctv@tamron.de  
web: www.tamron.eu

**TAMRON**

## CCTV

# Virtual Space in EMEA

## Bringing Virtualization to Storage Networks

**After years of enormous success in the North American market, Pivot3 has set its sights on new market opportunities. The company is now bringing its cost savings and state-of-the-art storage technology to the European market. In this article, we speak with Lee Caswell, founder and Chief Marketing Officer of Pivot3, Dieter Kondek, Vice President EMEA, Pivot3 and Paul André de Jong, Managing Director of Secura Systems GmbH, a trusted Pivot3 partner, about storing video, industry pain-points, virtualization and their mutual plans in the European market.**

**GIT SECURITY:** Mr. Caswell, can you tell us about the company's background?

**L. Caswell:** We founded Pivot3 in 2003 on the idea that revolutionary scale-out architecture would deliver large-scale, high-bandwidth storage using off-the-shelf hardware components combined with specialized software. Although the founding members are all IT industry veterans from companies like VMware, Compaq and Adaptec, we decided to focus our efforts on the physical security market, specifically surveillance, from the very beginning.

**That means storage for video by people who understand video?**

**L. Caswell:** Exactly, and this specialization has proven to be highly welcomed by the industry. Our field sales and support teams all have strong IT and IP video background while most of our system engineers are storage experts. Furthermore, our regional sales managers have all gathered experience in the IP video industry. Because of this experience, we are a competent partner in all stages of the respective projects.

**A specialization on a market segment which paid off?**

**L. Caswell:** It certainly did, obviously the total market for storage in surveillance is not quite as big as data storage, but it's growing fast and will continue to demonstrate a high growth rate over the next five to 10 years. Today, Pivot3 is already the prime IP ISCSI SAN storage supplier



Lee Caswell, founder and Chief Marketing Officer of Pivot3

for security markets worldwide and our growth rate in this sector is outperforming competitors like HP, Dell and EMC by far.

**Mr Kondek, after the success in North America, you now are focusing on EMEA?**

**D. Kondek:** Yes and over the last six months we are getting real traction in Europe. Our partners realize that Pivot3 is a product that can decisively contribute to winning IP video projects. We have already won projects in city surveillance, prisons, public transportation, distribution centers and retail chains that add up to hundreds of terabytes already.

**What's so special about storing video?**

**D. Kondek:** Surveillance data is always unique; streams are continuous and that's why bandwidth matters a lot. Next to that you are writing for 99% of the time, with occasional reads. Video surveillance is a capacity hungry application; whereas we say that a 400GB database is already quite big – in video surveillance we are talking massive capacities with sometimes 100s of terabytes. Above all that, customers and end users expect that the streams and recordings are highly protected and that the system is always running efficiently.

**So, storage plays a very important role in an IP video system?**

**L. Caswell:** Yes, you must keep in mind that with modern IP video systems the storage and servers account for approximately 40% of the total cost of the system. Many people often don't realize this and are very surprised when I highlight the fact that the EMEA market for storage in 2009 was 189PB (189,000TB) and it's expected to grow to 947PB in 2013. The main drivers will be specific vertical markets including government, law enforcement, transportation and education, but also other segments like retail, banking, casinos and gaming. The influx of surveillance cameras in these markets will rapidly increase the need for flexible and highly scalable storage solutions.

**What do you consider to be the top industry pain points?**

**L. Caswell:** The cost for storage is rising, due to the fact that more and more cameras are being deployed. This, in combination with the use of higher resolution cameras and the wish for longer retention times, means that more and more disks are needed and as a result we need more air conditioning, more power and more rack space.



**D. Kondek:** Correct, and the new expectation is that data is always available and as the complexity of systems increases and the resistance to expensive IT redundancy in a video surveillance project is growing, many traditional resellers of video surveillance systems feel threatened by new technology and the related support and implementation costs, which drives the need for cost effective, scalable and future proof solutions.

#### What makes Pivot3 so different?

**L. Caswell:** Pivot3 is the first and only storage company offering free virtual servers on its machines. By sharing the available extra processing power, we are able to run the video management application on the same hardware as the storage

#### So the virtualization helps to save costs?

**L. Caswell:** Yes, it saves enormously. We are not only reducing the acquisition cost by 25 % with cost savings on the servers but a further 20 % by eliminating the clustered servers. Also, the operational costs are cut considerably. By eliminating the servers we achieve savings of 40 % in power and cooling, and at least 40 % in rack space. Virtual systems are far more resilient in the field and our built-in failover reduces support costs drastically. Pivot3 helps scale-out for simplicity and cost, and ensures that capacity of the storage can be expanded on the fly with live cameras. Some of the other benefits to mention are the fact that we build systems with no single point of failure and the self-healing architecture keeps the applications up and running.

#### Does this cost reduction mean loss in performance?

**D. Kondek:** Not in the least, the opposite is the case. Not only does our appliance model reduce configuration risk, the introducing of virtual servers reduces power and cost by 40%. We provide a far better performing solution by bringing integrated failover, global sparing and automatic load balancing of the video streams over all appliances in the Pivot3 array to the market. The results are staggering.

**P. A. de Jong:** This is why Secura Systems is so excited to be representing Pivot3 in DACH, Benelux and Central Europe. With Pivot3, we are able to deliver cost-effective, manageable and scalable systems, which address the pain points in today's security solutions.

#### What are your future plans in Europe?

**D. Kondek:** Over the last six months, we have been building an EMEA team with experts from both the IT and the video industries. We have regional sales managers and system engineers in place in southern Europe, the UK and Scandinavia, whereas Secura Systems is covering DACH, BENELUX and central Europe with a team of sales and support engineers who are fully integrated in the EMEA team. The EMEA team is aiming to provide the best project and configuration assistance, system design as well as technical support, training and commissioning on-site. They are backed by our team in Houston, providing lab expertise, storage configuration and camera simulator programs.

We are here to help integrators get the message across to end users and mutually win projects.

#### That means EMEA is a focus market?

**D. Kondek:** It certainly is. We have set high expectations and goals for the EMEA market and are looking forward to expanding our presence in very close cooperation with our integrator partners.

**P. A. de Jong:** Currently, we are working on localization of product datasheets, A&E specifications and technology overview in quite a few European languages and will soon be launching a range of marketing activities including webinars, road shows, partner meetings and exhibitions. The market will be hearing a lot from Pivot3 in the near future.

Gentlemen, thank you very much for this interview.

Security, Hall 2, Stand 415

#### ► CONTACT

**Paul André de Jong**

Secura Systems GmbH, Diepholz, Germany

Tel.: +49 5441 9923680 · Fax: +49 5441 9923687

paul.dejong@securasystems.de

www.securasystems.de

## The HSM SECURIO does its job so that you keep yours.

OFFICE TECHNOLOGY

Protect yourself from serious financial damage and losing your job, reputation and esteem with an HSM SECURIO document shredder. The HSM SECURIO P36 provides data security everywhere in the office and gives you that good feeling of quality "Made in Germany".

www.hsm.eu



**HSM**<sup>®</sup>

Great Products, Great People.



## INTERVIEW

# Looking Forward to a Highly Defined Future

An Interview with Sanyo's European Sales Manager David Hammond

**In March 2010 David Hammond, whose career within the electronic security industry spans over 30 years, rejoined the CCTV division of Sanyo after a four year absence. In this interview with GIT SECURITY David explains what persuaded him to take up the position of European Sales Manager for Sanyo.**

**Mr. Hammond, what are the key reasons for you rejoining Sanyo?**

**D. Hammond:** The reasons are all very positive. In many ways I was sad to leave Samsung Techwin. It is a company which has made a massive investment in the CCTV industry and has very quickly established a substantial market share. I would like to think that through my efforts I had in some way contributed towards the company achieving that success. The attraction of what Sanyo had to offer with regards to career progression, however, was just too great.

**Were you not concerned about what the future may hold for Sanyo following its acquisition by the Panasonic Corporation?**

**D. Hammond:** Not in the slightest. I would not of course have rejoined Sanyo if I did not 100% believe that it had a long term and bright future. Since becoming a subsidiary of Panasonic, Sanyo has in fact been given every possible encouragement to continue to grow and invest in the future.

Within the CCTV division, for example, we have been investing in our technical and sales teams in the UK and in mainland Europe. As a result, since I rejoined Sanyo we have recruited seasoned professionals such as Steve Green, who was previously with Dedicated Micros, to join what is already a strong sales team.

**So what is it that Sanyo is doing which you find so exciting?**



**D. Hammond:** Sanyo are committed to building a pan-European infrastructure and I am delighted to be given a leading role in achieving this. The highest levels of pre and post sales support are essential if we wish to earn customer loyalty and we need to build on our reputation for being a technology leader. In this respect Sanyo's design engineers have introduced the 'Wow' factor into every new product recently introduced. The nine cameras in the Sanyo range of real time Full HD cameras are particularly impressive and will provide Sanyo, which is already a well respected CCTV brand, with a massive opportunity to achieve substantial market share.

**At Security Essen you will highlight your new range of HD cameras. Are you confident that in the foreseeable future there will be a sizeable demand for HD cameras?**

**D. Hammond:** Absolutely yes. We are confident that the large number of people expected to visit Essen 2010 will be impressed with our Full HD technology. The market seems to have very quickly made up its mind about Full HD technology. At Ifsec 2010 and at recent Expos in Amsterdam, Lisbon and Madrid, we have witnessed excitement rather than hesitancy from installers and system integrators in respect of taking the new technology on board. This interest has

certainly been helped by the fact that the price/performance ratio of our Full HD cameras is meeting customers' expectations. It is also perhaps stimulated by the fact that CCTV system specifiers are also consumers and are therefore seeing HD quality images on their home TVs. It is also very encouraging that many of the leading developers of security management software solutions wish to integrate our protocols into their software platforms.

HD cameras can deliver 'identification' grade images which is something the industry badly needs. Far too often CCTV has attracted negative publicity because the quality of images captured by standard cameras has not been of sufficient quality for security managers or the police to identify culprits. High definition gives us the opportunity to capture images which will allow a suspect to be identified rather than just using CCTV to verify that an incident has taken place.

**Are you then just concentrating on promoting Sanyo's HD camera range and nothing else?**

**D. Hammond:** Far from it. We have many other great products in our portfolio although feedback from customers and market research has led us to believe that there is tremendous potential for Full HD cameras if the pricing is right. We are now talking to installers and system integra-



tors, who we have not dealt with before, who are hungry to learn more about Full HD camera technology.

**What is special about the Sanyo HD range?**

**D. Hammond:** Firstly, I believe we have got the price level right. Normally when a new technology is introduced, the first generation of products associated with that new technology is too expensive to be considered for the majority of applications. Whilst our Full HD cameras are slightly more expensive than standard CCTV cameras, I nevertheless consider them to be affordable for a large number of CCTV projects where the cameras' impressive functionality and performance more than justifies the extra cost. When the images are seen, the product is sold - there is nothing quite like the HD performance.

Secondly we have a major advantage over our competition in that we have a complete range of HD cameras. Collectively, the nine cameras are designed to provide a solution for virtually any project with vandal resistant domes, PTZ cameras and a zoom camera included in the range, as well as a choice of three fixed cameras with CS mounts to provide a choice of lens.

All the cameras have the capability to capture full high definition (1,920 x 1,080) sharp and crystal clear colour images at 25 frames per second and are equipped with a Dual Codec to support both the latest H.264 compression standard as well as MJPEG.

**Can you give some examples of the kind of functionality which will attract the most interest?**

**D. Hammond:** The superb image quality and excellent colour rendition are of course the most obvious but the minimisation of bandwidth requirements by using H.264 compression is also very important. Installers should also be impressed with the Auto IP Setup Utility to facilitate IP address settings. A camera connected to a network is automatically detected by the software and an IP address is set automatically. The cameras also have a Focus Assist function. Simply pointing the camera at the target and pressing the Focus Assist button results in the lens camera automatically adjusting to the optimum position.

**Do you think that everyone understands how to get the best out of this new technology?**

**D. Hammond:** No and it is clear that there is a great hunger for information on how to capitalise on the substantial benefits offered by Full HD cameras. This is why we are developing modular training courses on the new technology, all of which will be certificated and tailored to cater for the specific requirements of different types of stakeholders, i.e. end-users, consultants, installers/system integrators and distributors.

**You certainly seem highly motivated.**

**D. Hammond:** I am and so is everyone else within the Sanyo team. The future is looking very positive for our leading technologies and for all those associated with the company. I am confident that we can achieve considerable success during 2010 and beyond with the help of our growing list of loyal customers.

Security, Hall GA, Stand 129

**▶ CONTACT**

Sanyo Europe Ltd., Watford, United Kingdom  
Tel.: +44 1923 477 220 · Fax: +44 1923 477 225  
cctv@sanyo.co.uk · www.sanyo.co.uk



**DIGITAL ABSOLUTE PLUS**

DIGITAL

**Dual TECHNOLOGY Barrier**

range 200 mt.

**IMN200RS series**

State of the art combination of Microwave and IR technologies to assure maximum protection while drastically reducing false alarm rates due to uncontrollable agents.

- Detection Mode: MW + IR
- Range: 200 mt.
- Heights: 2.0 - 2.5 - 3.0 - 4.0 mt.
- Nr. of IR beams: from 2 to 8
- Nr. of microwaves: 1 / 2
- Alarm signal: Contact Relay and/or RS-485
- RS-485 output for remote programming and diagnostic





**SICURIT** ALARMITALIA®

outdoor protection  
our profession

**SICURIT Headquarter**  
Via Gadames, 91  
20151 MILANO - Italy  
T : +39.02.380.70.1  
F : +39.02.308.80.67  
E: export@sicurit.it





5-8 October 2010  
**Hall 2**  
**Stand 511A**  
in partnership with  
WARNING-OPTO



MADE IN ITALY

## ACCESS CONTROL

# Online Access Control without Wiring

All Authorizations in One Legic ID at Crane Manufacturer Wilbert

The need for a new locking system as well as an access control and time & attendance system became apparent during new building work: The Wilbert Group employs around 140 staff and specializes in the manufacture, sale, lease, assembly and servicing of tower cranes. To date, the company has already produced 150 tower cranes and sold and leased them to customers throughout Europe and in Canada.

The time & attendance and access control system had to be both convenient and compatible with the existing payroll software. There was no question of installing an online access control system that involved wiring the doors because of the size of the company's site (12,000 m<sup>2</sup>). The idea of deploying a Kaba mechatronic solution was enthusiastically received. Wilbert had over 60 components from Kaba's product port-



folio installed. In addition, all security-relevant doors were equipped with self-locking anti-panic locks.

The Cardlink concept combines the online systems with the mechatronic locking system through a Legic credential. Employees' access authorizations are written to the Legic ID via online readers. The mechatronic component of the door checks whether the credential is valid and opens the door if the employee is authorized to enter. The door requires no other additional devices or wiring of any kind. A modern update mechanism ensures that users receive modified access rights easily and quickly on an online reader and transfers these rights to their personal identification credential at individual access points.

### Key Fobs

Wilbert opted for an employee ID in the form of a key fob because such fobs are small and can be securely attached to a bunch of keys. The entire system went live when the company moved into its new premises without having to perform

any prior testing. Since then, employees validate their Legic chip at the turnstile every day and are given appropriate authorization. The employees record also their presence times with time & attendance terminals from Kaba with the same comfortable and contactless chip.

"The Legic technology combined with the Kaba Cardlink concept impressed us", says Chief Executive Franz Rudolf Wilbert. "It enabled us to improve our corporate security. Previously, every day was an open-house day, now people can only enter areas which they are authorized to access."

Security, Hall 3, Stand 407

### ► CONTACT

Legic Identsystems Ltd,  
Wetzikon, Switzerland  
Tel.: +41 44 933 6464 · Fax: +41 44 933 6465  
info@legic.com · www.legic.com





# Intrinsic safety



Hazardous areas where an explosive mixture of air and gas or vapour may be present requires electrical equipment that cannot cause an ignition – not only in normal operation but also in fault conditions. The most common method of achieving this is intrinsic safety.

orbis™ IS (Intrinsically Safe) is a range of conventional detectors which has been developed from the standard range of Orbis smoke and heat detectors, specifically for safe operation in potentially volatile environments. The range has all the benefits of the standard range and remains electrically compatible with Apollo Series 60 IS conventional detectors, but now has Marine Approval and BS EN 60079 accreditation for hazardous areas.

Orbis IS is a demonstration of Apollo's commitment to the market for high quality conventional detectors for use in small to medium size installations. For ease of installation and reliability in daily operation specify Orbis IS.



II 1G Ex ia IIC  
-40°C > Ta < +40°C (T5)  
-40°C > Ta < +60°C (T4)

**orbis**™

To find out more:  
[www.apollo-fire.co.uk/orbis-is](http://www.apollo-fire.co.uk/orbis-is)  
call us on: +44 (0)23 9249 2412  
email us at: [marketing@apollo-fire.co.uk](mailto:marketing@apollo-fire.co.uk)

**apollo**  
WORLD CLASS FIRE SOLUTIONS



## ACCESS CONTROL

# A Different Approach Worth the Effort

## Cambridge Innovation Center Upgrades Its Access Control System



**When you're located just steps away from the campus of the Massachusetts Institute of Technology (MIT), one of the most prestigious technical schools in the world, building security and access control is a subject that has to be taken seriously. Cambridge Innovation Center (CIC) is a full-fledged managed office services facility at One Broadway providing space for growing technology and life sciences companies, professional service firms and venture capitalists looking to locate in the MIT/Harvard technology cluster of the Greater Boston area.**

With offices on 8 floors of the building, it services approximately 175 companies providing a range of high quality business and technology services tailored mostly towards small start up companies employing 1-5 people. These include flexible office configurations on a monthly rental basis, a secure facility featuring computerized access control and video surveillance for protection of intellectual property, advanced telephone and voicemail services, high tech video conferencing systems, high speed (100Mb) LAN connections and more.

### The Situation

For the past 10 months CIC has been exhaustively reviewing its door access control options. Since their inception they have used a traditional card-access system, manufactured and installed by a leading US corporation which has served CIC well over the years.

But as the business has grown, they have taken new space on additional floors that was only equipped with traditional mechanical key locks on the office doors. Because these doors were not hard wired, it would have been prohibitively expensive to upgrade the doors with the same electronic access control product fitted onto other doors within the building. While they strive not to let these mechanical or what they call „hard keys“ impact on their clients' ability to move offices, they haven't been happy with the limitations this imposes. For example, if a client needs access to two offices, they need two separate keys, and if an employee leaves and

takes a key with them, they have to make the call on whether or not to change the locks.

So they started a search for a better solution. With the upcoming expansion onto the 3rd and 4th floors at One Broadway, they knew they would be adding about 200 new doors to CIC, and this prompted them to accelerate their search for an alternative electronic system to control access.

### The Challenge

Initially they considered going down the integration route, finding a new product to work with their existing system, but having looked at



CIC staff try out the new wireless locks



it closely decided the results didn't measure up and this option was rejected.

In January this year they discovered Salto Systems and found their approach to access control to be somewhat different to other providers, with door control based on a data on card system, reversing the more usual role of credential and controller. The big advantage of this is that you do not have to hard wire every door, or install cumbersome and expensive controllers in a closet somewhere. This makes this system much faster to install and less expensive. This wireless system would allow them to put electronic access control on every door. Sean Keenan, Senior Systems Administrator at CIC says "When we first started looking at the system, as a tech guy, I immediately frowned, however, on the idea that I would be carrying my credentials around on my key ring – what if it gets lost, stolen, decrypted or copied?"

You have to remember, we are just steps away from MIT where world-class hackers just wait looking for a challenge! After getting more familiar with Salto, doing a lot of research and testing with our existing wireless technology and Salto's wireless locks (think Zigbee) to ensure compatibility, and exploring its layers of security features, we began warming to it. We also learned that it is in use at Heathrow Airport and at some US military bases - places that take security seriously. So now we faced the moment of truth. Would we stay with the old, tried and true system we have run for the past decade, accepting its limitations, or go with a whole new system, despite its unfamiliarity, and redo the entire center's access control from scratch, including all our existing doors?"

### The Solution

In the end CIC took the road less traveled, and decided to rebuild the entire system. They have now embarked on that process, and couldn't be happier. And while this means a great deal of

work upgrading every door both electronic and keyed throughout the whole center (although retro-fitting a standard hard keyed door is a mere 15 minute operation), it's worth the effort.

The system they chose is the Salto XS4 wireless solution. The bi-directional technology of this system combines the advantages of both on-line and off-line solutions. Any number of doors can be wirelessly connected to the system thanks to its IEEE 802.15.4 and 2.4 GHz technology. Gateways and repeaters act as antennas, collecting and sending information from the PC via Salto SQL software, to the stand alone wireless locks (which use AES 128 encryption) and one gateway can manage several repeaters and electronic locks, minimizing infrastructure costs and maximizing flexibility.

With a single click CIC can configure or make changes to the network in real time. They can monitor the network, download audit trail information from the locks, delete users remotely and securely, collect battery status of the RF locks for maintenance and much more all from a single controlling PC and all in real-time. And thanks to its self-healing capabilities, if an individual lock should lose RF connection at any time it will automatically scan for a new connection to an alternative gateway or repeater, restoring communication and maintaining security.

"So, you may be asking, what does it mean for our clients?" Keenan continues. "Well, apart from seeing new locks on their office doors and getting new key fobs with high-tech encryption, like many of the technical systems at CIC most of the magic happens behind the scenes.

Although our eventual aim is to have Salto wireless locks on all our floors by the end of the year, the new system will appear to clients to be much like the old system, securing the lobbies and office doors while still allowing 24/7 access. One added feature on this front will be electronic access to the stairwells. After the upgrade, CIC

clients will be able to move between CIC floors without having to wait for the elevators.

We began the move over to Salto in early June, starting with a review of their system software. This then progressed to retro-fitting the new wireless locks onto 10 office and closet doors, one Uno office and one shower room on the 11<sup>th</sup> and 14<sup>th</sup> floors replacing a previous mix of hard wired electronic and mechanical keyed doors.

Over the next few months more and more of this conversion process will roll out throughout the center, with expansion onto the 3<sup>rd</sup> and 4<sup>th</sup> floors completing on Sept 1<sup>st</sup>. Installation and set-up is being managed by two Salto Service Partners. Its my understanding that we will have one of the largest concentrations of RF locks in one building in North America when we're done, with some floors operating upwards of 130 locks, so you can say that we're definitely looking forward to flexing the benefits that Salto brings to the table."

Ion Murga, Marketing Manager in the US for Salto Systems says "An effective, robust access control system is a key requirement for any building with multiple tenants. Its objectives should be to control and restrict access to authorized personnel and areas, prevent and prohibit all likely security threats from occurring and reduce the degree of vulnerability of critical assets to theft. The Salto XS4 wireless access control system achieves all these objectives. With an expanding business and an increasing number staff, clients and visitors on site every day, the number of users and doors the system can manage is unlimited, giving CIC the scalable future-proof solution they need."

Security, Hall 12, Stand 106

### ▶ CONTACT

Salto Systems, Oiarzun, Spain  
Tel.: +34 943 344 741 · Fax: +34 943 341 621  
www.saltosystems.com



## NPX4800 NPX 4800-IPD

- a new dimension in video wall control

- ) Cutting-edge switch fabric technology
- ) Almost unlimited number of inputs
- ) Hardware decoding of IP video streams with the NPX-4800-IPD
- ) Support of thousands of cameras
- ) Less power consumption, less noise emission
- ) Fully compatible with eyevis display products and software

The NPX4800 controller can be equipped with various input cards for video and graphic integration. Analog/digital video and RGB windows can be moved, scaled and placed freely on the display wall.

The core of the system is the ultra-fast PCIe Switch Fabric with a total bandwidth of 100GB/s for transmitting, network data, video, digital streams and graphic signals to each output card.



Visit us at  
Security in Essen  
5<sup>th</sup> - 8<sup>th</sup> October

## ACCESS CONTROL

# Putting the Face to the Name

## Integration of Access Control and Video Surveillance

Combining access control and digital video in a single system is easy with Bosch's new generation of access controllers. The controllers support direct integration with the company's latest IP cameras, enabling essential security functions such as video verification and video surveillance both live and via playback, all performed within a web browser and with no additional software needed.

There's no question that video verification enhances the security of access control systems. It enables, for example, the operator to immediately spot attempts at tailgating (several people trying to pass through a door on a single card), ensuring that the credential belongs to the person who is carrying it. It also aids in granting access only to authorized persons to designated areas. When a person requests entry, the cardholder's image and a live camera view automatically appear on screen for verification, giving the operator the power to grant or deny entry based on the image received on his monitor. In addition, live video can be displayed if an alarm is received from a door, if a door is held open or an unauthorized credential is presented for example, and it is also possible to view archived video associated with the alarm.

One of the easiest ways of setting up such a system is with Bosch Security Systems' Access Easy Controller (AEC) 2.1 combined with a CCTV system based around the company's new IP Camera 200 series. This is an easy-to-use, web-based access control solution that uses a built-in web server for access management. It enables a range of sophisticated security features to be



## System Solutions for Homeland Security

### Telestat - fast information from the air

- ◆ Obtaining an overview of the situation through real-time videos and high-definition images
- ◆ Fast deployability
- ◆ Easy to use: simple approval process and no flight control required
- ◆ Cost-effective solution

TELEFUNKEN Radio Communication System GmbH & Co. KG member of

HLS@tfk-racoms.com  
www.tfk-racoms.com

**Elbit Systems**

## Homeland Security

Meet us at the  
**'Security 2010' in Essen –  
Hall 7.0, Booth 325**





FITTINGS  
CAN BE  
ATTRACTIVE  
TOO.



integrated into a system, even by users with relatively little IT knowledge and access control experience. The AEC can be accessed via a standard IP network or the Internet and, once installed, the controller can be managed from any PC connected to the network or Internet using any standard web browser. It can support up to 16 readers, monitor up to 32 input points and control up to 32 output points, and with its highly intuitive graphical user interface, it's easy to set up and operate. Once integrated with video, the controller offers the advantage of enabling up to three cameras to be added per door with the operator being able to toggle between the different view points.

### Card Storage

The company's IP Camera 200 series was recently introduced as a cost-effective solution to enable small businesses and enterprises to protect and monitor their property. Ready-to-use straight from the box, the new compact cameras can operate without a DVR or PC. They start recording as soon as they are installed, and they can store several days of video footage on an SD memory card.

Cameras in the IP 200 series can also be seamlessly integrated into the AEC 2.1 system to provide a wide range of sophisticated features, such as verification of alarm-related images and guided playback of archives, without losing the system's inherent ease of use. Additional security features can be customized by the operator, such as display of photo ID and notification or alerts via email/SMS. More advanced I/O programming is also available for additional security functions such as integration of third-party intrusion systems for arming/disarming the system via a standard access credential.

### Search and Find

With the correct minimum firmware, the VSDK and ActiveX software installed, the cameras can be selected by using the camera auto detection function in the configuration menu. This auto

detects any connected IP cameras. The storage location for snapshot and exported video is then selected and installation of the access control system with digital video is then complete. Once all cameras are correctly configured with the Access Easy interface, the system gives operators the ability to easily use video images together with access control to increase the security of any premises in a faster and more convenient manner.

To perform video surveillance, the required camera is selected from a drop-down button which then delivers live images from the connected camera. It is also possible to toggle between live and playback modes in which the date and time of the required video can be entered and recorded material viewed. All events on the logbook that have an associated video image are displayed with a camera icon next to the event. To view the image, the operator can simply click on the icon. This time-saving function avoids the need to access the digital video recorder and search for images manually.

### Open Sesame

Another useful application is video verification to verify the credentials of the person who is requesting access to a door. With this function, when an entry is requested, the system will display the stored image of the person associated with the card at the time of enrollment alongside the live video. The operator is then given the choice with two buttons to grant or deny entry by opening the requested door or keeping it closed and calling for further security measures.

Security, Hall 1, Stand 140C and  
Hall 3, Stand 409

### ▶ CONTACT

Bosch Security Systems, Ottobrunn, Germany  
Tel.: +49 89 6290 1647 · Fax: +49 89 6290 281647  
emea.securitysystems@bosch.com  
www.boschsecurity.com



VISIT US  
AT SECURITY  
IN ESSEN,  
HALL 11,  
STAND 404.

### Digital SmartHandle 3062.

Our digital SmartHandle 3062 has won the red dot design award and has been nominated for the Deutscher Designpreis 2011 (German Design Award 2011). The technology is impressive too. It offers a long battery service life, can be networked directly and features a special highlight – snap-in installation. Simply attach the fitting to the door leaf, tighten the screw, and you're done! Typically SimonsVoss.

Phone: +49 89 99228-0  
www.simons-voss.com

## LOCKING SYSTEMS

# Pick the Right Lock

## Using Digital Door Furniture for Discrete Access Control



**SimonsVoss Technologies AG, based in Unterföhring near Munich launched its 3060 digital locking and organization system in 1998. Since then, the company has reinvented the traditionally mechanical field of locking technology and is now a major supplier of battery-operated electronic locking and access control systems. The digital door fitting combines intelligent access control with elegant and ergonomic design, concealing highly innovative technology within.**

Within the digital locking and access control system 3060, the Smart Handle 3062 communicates wirelessly with the identification media, and controls where and when up to 64,000 users are granted access. Authorization can be altered or access lists read out, doors remotely opened or digital locks and catches deactivated in case of danger, from any place in the world. For this, the data is transmitted over a secure network, which can be either via Ethernet, WLAN, RS485 interface or any

combination of these media. The Smart Handle 3062 can additionally be utilized as a ‚gateway‘ in a G2-based virtual SimonsVoss network.

It is particularly worth mentioning some of the functionality that can thereby be achieved. For example, the administrator can receive a message from the system when specific actions are carried out, such as the alteration of authorizations or the blocking of transponders. Event vouchers can be generated, and validation made according to specific criteria so that, for example, a transponder is automatically deactivated after a preset period of time or at a particular time and only reactivated after presentation at the gateway.

### No Visible Change

The unique aspect of the 3062 digital door fitting is that it can be mounted quickly and easily on DIN doors, without wiring and without the need to drill holes. This means that the locks can be fitted in rented property, and when the company moves or there are alterations in the company structure, they can be removed again without leaving any marks or damage. Mounting the locks is made considerably easier thanks

to a patent-pending principle whereby only a single screw must be tightened for a permanent, sturdy fastening to secure the fitting. The battery change intervals of up to 10 years also set new standards.

The Smart Handle is activated by an authorized transponder. It communicates without contact with the identification medium and thereby controls access for up to 64,000 users according to their location and time. They open the door simply by pressing the doorknob. This simple operation makes the 3062 door latch particularly suitable for installation in nursing homes and rest homes.

The Smart Handle 3062 digital door latch will be presented at the Security trade fair in Essen and is expected to be available as from Q2/2011.

**Security, Hall 11, Stand 404**

### ► CONTACT

**ONE BUSINESS PARTNER**

**Nicole Huffer**

SimonsVoss Technologies AG, Unterföhring, Germany  
Tel.: +49 89 99228 0 · Fax: +49 89 99228 222  
marketing@simons-voss.com · www.simons-voss.com



### Isolated Spots

Watching over isolated spots is now a necessity. It is in this context that the police from Molsheim (a town in the east of France) and RSI Video Technologies combined their skills and try to stop thefts. The Videofied outdoor system aims at stopping the looting of isolated spots that affects all activity sectors. These thefts are becoming expensive and have a negative impact on working conditions. "With videofied and its images of intrusion, the police intervene directly," said Jeanne-Marie Ferré, Marketing & Communication Manager. The law requires it in most countries of the world: in case of an alarm signal received by a monitoring center, it is mandatory to have visual evidence of burglary before alerting the police. Offenders can be fined in order to avoid unnecessary interventions (more than 95 % of setting off alarms are due to incorrect manipulations), but mainly to increase the effectiveness of the police, which is to be called only if clearly needed. Videofied is the only system suitable for isolated sites today, the company claims. While with conventional detection systems the intervention of a security team takes over 40 minutes on average, the visual check allows video to directly involve the police in an emergency, as provided by the law. Based in Strasbourg, the company develops solutions to the problem of security against intrusion. Already available in France by leading suppliers of security systems such as banks or insurance companies and monitoring companies, the products have been installed in with over 150,000 systems worldwide. [www.rsvideotech.com](http://www.rsvideotech.com)

### Vandal Resistant Camera

Vista has introduced the VK2-540VRD 540TVL high-resolution vandal resistant camera with H.264 compression and Power over Ethernet (PoE). Simple to use and easy to set up, it has an IP output and a standard analogue BNC output, allowing it to be used in both IP and standard coax based systems. As part of the Vip-Kit2 range, it is supplied with its own management software free of charge. PoE operation allows power to be sent over Cat5 cable, enabling existing cabling to be used rather than incurring the added cost of extra cable installation. There are a number of recording options, including manual, alarm and motion detection along with a simple search and play back feature. Smaller file sizes, and hence more efficient recording, can be achieved thanks to the H.264 format. [www.vista-cctv.com](http://www.vista-cctv.com)



### Two-wire Tire Alarm Panels

Kentec Electronics launched the Alarmsense compatible Sigma CP-A 2, 4 and 8 zone fire alarm control and indicating panels. The range is compliant with European standards BS EN54-2 and BS EN54-4. Apollo Alarmsense devices, including smoke and heat detectors, call points, base sounders, base sounder/beacons and relay units, can all be wired to the same pair of cables, with rapid system configuration for common, zonal or two-stage alarm using simple menu options on the panel. False alarm management is particularly efficient, with alarm verification via the general and local alarm facility on Alarmsense sounders and beacons, a significant feature for HMO (Houses of Multiple Occupation) applications. All control panels have an integral, mains powered battery charger and power supply compliant with the requirements of BS EN54-4. [robine@kentec.co.uk](mailto:robine@kentec.co.uk)

### C-Tec to Launch New Products at Security Essen 2010

C-TEC is set to launch a host of new products at Germany's biggest security show, Security Essen. On display will be the company's third-party VdS approved EN54-4 compliant power supplies, new additions to the company's popular analogue addressable/conventional fire alarm control panel range and the new improved Quantec nurse-call/staff attack system, which now includes features such as 'Attendance' and 'Staff Tracking'. Says Sales Director Charlotte Manley: "This year's Security Essen promises to be very exciting. C-Tec's products are selling exceptionally well in Europe and our customer base has significantly expanded. As such we anticipate an excellent return on our investment in introducing new products exclusively designed for the European market." [marketing@c-tec.co.uk](mailto:marketing@c-tec.co.uk)



Security, Hall 1, Stand 501

### Multi-site Security Management Software

Xtralis has launched Adpro Videocentral Platinum, the latest addition to its Adpro range of proactive security solutions. It is a multi-site security management software application designed to monitor video and audio from remote sites using the company's video transmission systems, including the new V3100 Hybrid Network Video and Audio Transmitter/Recorder and the Fasttrace Video and Audio Transmitter/Recorder. Modelled on the existing Videocentral Gold interface for easy transition and supporting the latest Microsoft operating systems, the software is a single-version product that supports multiple PCs and operators. It is ideal for either central monitoring station and/or command centre applications, or for a single operator or laptop user who requires only periodic site monitoring. [www.xtralis.com/multisitesecurity](http://www.xtralis.com/multisitesecurity)



### Cargo Inspection

L-3 Security & Detection Systems announced that its CX-Pallet dual-view cargo inspection system helped the Australian Customs and Border Protection Service uncover 240 kilograms of cocaine hidden in a shipment of concrete pavers. The CX-Pallet was installed at the Port Melbourne Cargo Examination Facility in June of this year. "We are pleased that our recently deployed inspection system has been effective in helping Customs and Border Protection detect illegal substances," said the company's president Thomas M. Ripp. "The CX-Pallet speeds the screening of consolidated cargo with superior imaging technology, helping customs personnel identify suspicious content more efficiently." [www.L-3com.com](http://www.L-3com.com)



# High-Definition Low-Light

## 1080p/720p 50/60fps Camera

**HD-IP CAM**

- HD 720p Multiple-streaming
- Codecs: H.264 /MPEG-4 /M-JPEG
- CVBS

**3M DSP**

**3G-SDI CAM**

- Uncompression video: 720p/1080p
- Video transmission based on coaxial cable
- Bit rate: 2.97Gb/s SMPTE 292M/424M
- One cable (Video/Audio/RS-232C/Power embedded)
- CVBS

**Megapixel Camera Module**

- Image sensors: 1.3-3M CMOS/CCD Sensor
- Built-in AFM926-EJ-S/Memory
- Digital video output: YUV 4:2:2 16 Bit (SMPTE 274M/296M)
- CVBS output: 560TV or 700 TVL (NTSC / PAL)
- Image adjustable: Peak/BLC/XDR/3D DNRA/E.S./ DC-IRIS/removable IR-Cut
- Communication: RS-232C/OSD
- Low power consumption

Booth  
2010 October 11-14  
M802

**MINTRON ENTERPRISE CO., LTD.**  
 No.123,Wu-Kung 1 Rd., Wu-Ku Industrial Park, Taipei (248), Taiwan  
 Tel : 886-2-22990277 E-mail: [service@mintron.com.tw](mailto:service@mintron.com.tw)  
 Fax: 886-2-22989375 Web : [www.mintron.com](http://www.mintron.com) Skype: mintron3601

### Security Management



### Security Management



Schille Informationssysteme GmbH  
Goseriede 4 · D-30159 Hannover  
Tel. +49(0)511/542244-0 · Fax +49(0)511/542244-22  
info@schille.com · www.schille.com  
Facility and building management and security technology, fault and hazard management systems, OPC development, video surveillance systems

### Facility Security



### Security Management

**ABUS Security-Center** 

ABUS Security-Center GmbH & Co. KG  
Linker Kreuthweg 5, D-86444 Affing  
Tel. +49 (0) 8207 / 9 59 90 - 333  
Fax +49 (0) 8207 / 9 59 90 - 100  
info.de@abus-sc.com · www.abus-sc.com  
ABUS Security-Center is one of the leading manufacturers of electronic security technology. As a full-line supplier, ABUS Security-Center consistently markets an international range of products and services for the market segments of intrusion detection and video surveillance.

### Alarm Management



### Facility Security

**DICTATOR**

Dictator Technik GmbH  
Gutenbergstr. 9 · 86356 Neusäß  
Tel. +49(0)821/24673-0 · Fax +49(0)821/24673-90  
info@dictator.de · www.dictator.de  
Drive units, hold open systems and smoke detectors, door control solutions

### Security Management

**advancis**  
SOFTWARE & SERVICES

Advancis Software & Services GmbH  
Monzastraße 2 · D-63225 Langen  
Tel.: +49 (6103) 80735-0 · Fax: +49 (6103) 80735-11  
info@advancis.de · www.advancis.de  
WinGuard – Integral system for security and building management, control and visualization, alarm management, video management, communication

### Alarm Management

**DAITEM**

ATRAL-SECAL GmbH  
Service Daitem  
Thaddenstr. 4 · D-69469 Weinheim  
Tel. +49(0)6201/6005-0 · Fax +49(0)6201/6005-15  
info@daitem.de · www.daitem.de  
Radio-controlled burglary alarm systems, radio-controlled fire warning devices, distribution via security suppliers

### Facility Security

**GEZE**

GEZE GmbH  
Reinhold-Vöster-Str. 21-29 · D-71229 Leonberg  
Tel. +49(0)7152/203-0 · Fax +49(0)7152/203-310  
vertrieb.services.de@geze.com · www.geze.com  
Automatic door systems, security systems, security locks

### Security Management

LevelOne is a trademark of Digital Data Group 

Digital Data Communications GmbH  
Zeche-Norm-Straße 25 · D-44319 Dortmund  
Tel. +49 (0) 231-9075-222 · Fax +49 (0) 231-9075-184  
sales@level-one.de · www.level-one.de  
LevelOne provides full service – even when it comes to security: A broad range of high quality IP-products, combined with expertise in projects, assure reliable security solutions in all dimensions.

### Alarm Management

**DIGISOUND**

Digisound Electronic GmbH  
Oststraße 54 · 22844 Norderstedt  
Tel. +49(0)40/526869-0 · Fax +49(0)40/526869-13  
info@digisound.de · www.digisound.de  
Acoustic buzzers, piezo-electric sounders, electronic beacons, speakers, and transducers

### Facility Security

**Simons Voss technologies**

SimonsVoss Technologies AG  
Feringastr. 4 · D-85774 Unterföhring  
Tel. +49(0)89/99228-180 · Fax +49(0)89/99228-222  
marketing@simons-voss.de · www.simons-voss.de  
Digital locking and organisation systems with optional access control and time recording

### Security Management

**funkwerk**   
plettac

Funkwerk plettac electronic GmbH  
Würzburger Straße 150 · D-90766 Fürth  
Tel. 0911/75884-0 · Fax 0911/75884-220  
info@plettac-electronics.de  
www.cctv-systeme.com  
CCTV, system solution, system integration, video monitoring security, building management

### Alarm Management

**TAS**  
TELEKOMMUNIKATION  
SICHERHEITSTECHNIK  
GEBÄUDEMANAGEMENT  
DATENTECHNIK

TAS Telefonbau  
A. Schwabe GmbH & Co. KG  
Langmaar 25  
D-41238 Mönchengladbach  
Tel. +49 (0) 2166 858 0 · Fax: +49 (0) 2166 858 150  
info@tas.de · www.tas.de  
Manufacture and development of: alarm and conference units, VoIP- or ISDN emergency technology, alarm transmission systems

### Video Technology



### Security Management

**Honeywell**

Honeywell Security Group  
Novar GmbH  
Johannes-Mauthe-Straße 14 · 72458 Albstadt  
Tel.: +49(0)74 31/8 01-0 · Fax: +49(0)74 31/8 01-12 20  
www.honeywell.com/security/de  
E-Mail: info.security.de@honeywell.com  
Biometrics, video surveillance systems, access control, time recording

### Alarm Management

**tetronik**

tetronik GmbH  
Angewandte Elektronik und Nachrichtentechnik  
Silberbachstr. 10 · D-65232 Taunusstein  
Tel. +49-6128-963-1 · Fax +49-6128-963-499  
info@tetronik.com · www.tetronik.com  
broadcasts and alarms, telephone conferences, personal security measures with location tracking and visualisation, one number services and group calls, announcement and open listening services, telephony access services for host systems

### Video Technology

**ABUS Security-Center** 

ABUS Security-Center GmbH & Co. KG  
Linker Kreuthweg 5, D-86444 Affing  
Tel. +49 (0) 8207 / 9 59 90 - 333  
Fax +49 (0) 8207 / 9 59 90 - 100  
info.de@abus-sc.com · www.abus-sc.com  
ABUS Security-Center is one of the leading manufacturers of electronic security technology. As a full-line supplier, ABUS Security-Center consistently markets an international range of products and services for the market segments of intrusion detection and video surveillance.



**aimetis**

Aimetis GmbH  
Am Prime Parc 7 · D-65479 Raunheim  
Tel. +49 (0) 6142 20798 60 · Fax +49 (0) 6142 20798 89  
info@aimetis.com · www.aimetis.com  
Aimetis Symphony™ is award-winning intelligent video surveillance software that offers a single, innovative, open IP video platform for video management, video analytics, system integration and alarm management.

**DYNACOLOR**  
always watching

DynaColor, INC.  
No. 116, Jou Tz Street, Neihu, Taipei 114, Taiwan  
Tel. +886 2 2659-8898 · Fax: +886 2 2659-8868  
info@dynacolor.com.tw · www.dynacolor.com.tw  
Manufacturer of digital surveillance products covering HD/SD speed dome cameras, Full HD/HD WDR IP cameras & H.264 Hybrid D1 Real-time DVRs

**HeiTel**  
DIGITALVIDEO

HeiTel Digital Video GmbH  
Stuthagen 25 · D-24113 Molfsee/Kiel (Germany)  
Tel. +49(0)4347/903-0 · Fax +49(0)4347/903-400  
info@heitel.com · www.heitel.com  
Digital Video Transmission and Recording, Video Management, Monitoring Station Integration

**AXIS**  
COMMUNICATIONS

Axis Communications GmbH  
Lilienthalstraße 25 · D-85399 Hallbergmoos  
Tel. +49 (0)811 55508-0 · Fax +49 (0)811 55508-69  
info-de@axis.com · www.axis.com  
Network video equipment – the AXIS IP-Surveillance allows remote access video management

**eneo**

Eneo is a registered trade mark of VIDEOR E. Hartig GmbH, Rödermark. Distribution via authorized dealers and installers.  
info@eneo-security.com · www.eneo-security.com  
Products and solutions for video security applications

**logiware**

logiware gmbh  
Alfred-Mozer-Str. 42 · D-48527 Nordhorn  
Tel. 05921/7139920 · Fax 05921/7139929  
info@logiware.de · www.go1984.de  
Software, video transmission systems, security, video, video surveillance systems, digital video surveillance, networking

**bwa**  
endless video coverage

BWA Technology GmbH  
Johann-Krane-Weg 37 · D-48149 Münster  
Tel.: +49(0)251/289199-0 · Fax: +49(0)251/289199-29  
info@bwatech.com · www.mybwa.com  
Video analytics and high-efficient, compact H.264/MPEG4 solutions

**Be Part of the Section**  
**GIT BUSINESSPARTNER**  
The Purchasing Section for direct contact  
**Just send a mail to**  
**heiko.baumgartner@wiley.com**  
**We will be glad to advise you!**

**milestone**

Milestone Systems Germany  
Harald Zander, Country Manager  
Eltviller Str. 5, 65197 Wiesbaden  
Tel. +49 (0) 611 168 5597  
Mobile +49 (0) 176 62479674  
www.milestonesys.de  
Milestone Systems is the leading global developer of open platform IP video management software. XProtect™ is a powerful surveillance solution that is easy to manage and supports the widest choice in network hardware and integrations with other business systems.

**Convision**

Convision Systems GmbH  
Gablonzstraße 9 · D-38114 Braunschweig  
Tel. +49(0)531/26450 - 0 · Fax +49(0)531/26450-10  
info@convision.com · www.convision.com  
Remote video transmission with long term and event driven recording. Live video image transmission, alarm messages or status reports can be send by Email, SMS or FTP. Display via standard internet browser.

**Everfocus Electronics AG**

Albert-Einstein-Str. 1 · 46446 Emmerich  
Tel. +49(0)2822/9394-0 · Fax +49(0)02822/9394-95  
info@everfocus.de · www.everfocus.de  
Digital video technology, video remote surveillance, video surveillance

**MINTRON**

MINTRON ENTERPRISE CO. LTD.  
No. 123, Wu-Kung 1 Rd., Wu-Ku Industrial Park, Taipei 248, Taiwan  
Tel. +886 2 22990277 · Fax +886 2 22989375  
service@mintron.com.tw · www.mintron.com  
Skype: mintron3601  
Manufacturer of extensive range CCD cameras and board type cameras. OEM & ODM projects are welcomed.

**Dallmeier**

Dallmeier electronic GmbH & Co. KG  
Cranachweg 1 · 93051 Regensburg  
Tel. +49(0)941/8700-0 · Fax +49(0)941/8700-180  
info@dallmeier.com · www.dallmeier.com  
Video: digital storage systems, image transmission, available through specialized retailers

**eyevis**  
PERFECT VISUAL SOLUTIONS

eyevis GmbH  
Hundschleestr. 23 · D-72766 Reutlingen  
Tel. +49(0)7121/43303-0 · Fax +49(0)7121/43303-22  
info@eyevis.de · www.eyevis.de  
Large surface displays of security information in control rooms

**MOBOTIX**  
Security-Vision-Systems

MOBOTIX AG  
Security-Vision-Systems  
Kaiserstrasse · D-67722 Langmeil  
Tel. +49 (0) 6302/9816-0 · Fax +49 (0) 6302/9816-190  
info@mobotix.com · www.mobotix.com  
HiRes Video Solutions – high resolution, digital & cost effective recording

**DEKOM**  
VISIONS AND SOLUTIONS

DEKOM Video Security & Network GmbH  
Hoheluftchaussee 108 · D-20253 Hamburg  
Tel. +49(0)40/4711213-0 · Fax +49(0)40/4711213-33  
dekom@dekom.de · www.dekom.de  
Offices in Cologne/Erkelenz, Stuttgart, Munich, Bremen, Schönewörde/Magdeburg and Berlin.  
Future-oriented video monitoring systems with digital recording facility and transmission in LAN, WAN and ISDN networks

**Genetec**

Genetec  
2280 Alfred-Nobel Blvd  
Suite 400, Saint-Laurent · Quebec, H4S 2A4, Canada  
Tel. +1/514 332-4000 · Fax: +1/514 332-1692  
info@genetec.com · www.genetec.com  
IP Security Solutions for Video Surveillance, Access Control and Licence Plate Recognition

**MONACOR**  
INTERNATIONAL

MONACOR INTERNATIONAL  
Zum Falsch 36 · 28307 Bremen  
Tel. +49(0)421/4865-0 · Fax +49(0)421/488415  
info@monacor.de · www.monacor.com  
Video monitoring components and systems

Video Technology



opto-system-technik  
Video-Vertriebsgesellschaft mbH  
Planiger Straße 34 · D-55545 Bad Kreuznach  
Tel. +49(0)671/4830-10 · Fax +49(0)671/4830-11  
info@opto-system-technik.de  
www.opto-system-technik.de  
Distributor of SONY, SANYO, Pelco,  
Dedicated Micros and EverFocus

Video Technology



VTQ Videotronik GmbH  
Grüne Straße 2 · D-06268 Querfurt  
Tel. +49 (0) 34771-5 10 · Fax +49 (0) 34771-2 20 44  
main@vtq.de · www.vtq.de  
systems for digital and analogue wireless video,  
audio and data transmission, COFDM modulation,  
MPEG2 compression, directional radio systems,  
Diversity systems

Time + Access



deister electronic GmbH  
Hermann-Bahlsen-Str. 11  
D-30890 Barsinghausen  
Tel. +49(0)5105/516-01 · Fax +49(0)5105/516-217  
info@deister-gmbh.de · www.deister.com  
access control; vehicle identification;  
biometric verification; guard tour systems;  
storing and management of keys and valuables

Video Technology



PENTAX Europe GmbH  
Security Systems Division  
Julius-Vosseler-Str. 104 · D-22527 Hamburg  
Tel. +49(0)40/561 92-109 · Fax +49(0)40/561 92-334  
ssd@pentax.de · www.pentax.de  
CCTV lenses for video surveillance, image proces-  
sing, accessories for CCTV lenses

Be Part of the Section



Just send a mail to  
[heiko.baumgartner@wiley.com](mailto:heiko.baumgartner@wiley.com)  
We will be glad to advise you!

Zeit + Zutritt



DigiMem Deutschland Ltd & Co KG  
Büro Wiesbaden: Didierstraße 7 · D-65203 Wiesbaden  
Tel: +49 (0)611 710 9949 · Fax: +49 (0)611 710 9952  
david@digimem.eu · www.digimem.eu  
DigiMem is the appointed agency of Datakey Electronics  
(USA) and provides full bi-lingual sales and service sup-  
port for German, Swiss and Austrian customers. Supply  
of Datakey Keys and Tokens, accessories and periphery to  
OEMs. Support with the integration of these components  
into an application to ensure a turnkey system.

Video Technology



SANYO VIDEO Vertrieb AG  
An der Strusbek 31 · 22926 Ahrensburg · Germany  
Tel. +49 4102 4798 0 · Fax +49 4102 4798 10  
info@santec-video.com · www.santec-video.com  
Video monitoring technology · Video-over-IP  
Outdoor IR sensors · Planning and Services

Biometrics



Time + Access



FEIG ELECTRONIC GMBH  
Lange Straße 4 · 35781 Weilburg  
Tel. +49(0)6471/3109-44 · Fax +49(0)6471/3109-99  
obid@feig.de · www.feig.de  
Electronic locking systems, identification, access  
control, access road control

Video Technology



viasys Intelligent Video GmbH  
Koselstraße 20, D-60318 Frankfurt am Main  
Tel. +49 (0)69/7191 388 – 0  
Fax +49 (0)69/7191 388 – 66  
jourd@viasys-iv.com · www.viasys-iv.com  
Intelligent video sensors (3D, direction, sensitivity),  
reliable alarms, especially outdoors, connection to  
Alert Centre

Biometrics



Ident Technologies GmbH  
Rudower Chaussee 29 · D-12489 Berlin  
Tel. +49(0)30/63922568 · Fax +49(0)30/63922569  
info@identtechnologies.de · www.identtechnologies.de  
We create biometric Systems, to make our life  
easier – the fingerprint will be our key.

Time + Access



Gantner Electronic GmbH  
Montafonerstraße 8 · A-6780 Schruns  
Tel. +43 5556 73784-542 · Fax +43 5556 73784-8000  
info@gantner.com · www.gantner.com  
access control solutions/biometrics,  
time management, data capture, locking systems

Video Technology



VICON Deutschland GmbH  
Kornstieg 3 · D-24537 Neumünster  
Phone: +49(0)4321/879-0 · Fax +49(0)4321/879-97  
info@vicon-cctv.de · www.vicon-cctv.de  
VICON as one of the world's leading independ-  
ent manufacturers of CCTV equipment, offers a  
complete portfolio of the most advanced video  
management products.

Time + Access



Time + Access



Hinn Kft.  
Postfach 257 · Síkvölgy hrsz.0778.  
H-2800 Tatabánya  
Tel. 0036-34-512-302 · Fax 0036-34-512-308  
hinn@hinn.de · www.hinn.eu  
numberplate recognition, barrier- and gate-control,  
smart anpr modules, parking automat, access  
control, video picture processing and analysis, high  
end video converter

Video Technology



VIDEOR E. Hartig GmbH  
Carl-Zeiss-Str. 8 · 63322 Rödermark/Germany  
Tel. +49(0)6074/888-300 · Fax +49(0)6074/888-100  
security@videor.com · www.videor.com  
Distribution of complete product ranges for video  
security and video networking

Time + Access



Cichon+Stolberg GmbH  
Wankelstraße 47-49, 50996 Köln  
Tel. +49(0)2236/397-200 · Fax +49(0)2236/61144  
info@cryptin.de · www.cryptin.de  
Operational data collection, time recording,  
access control

Time + Access



ISGUS GmbH  
Oberdorferstr. 18-22  
78054 Villingen-Schwenningen  
Tel. +49(0)7720/393-0 · +49(0)7720/393-184  
info@isgus.de · www.isgus.de  
Operational data capture, personnel scheduling,  
time management, access control



**Time + Access**



**LEGIC**  
innovation in ID technology

LEGIC Ident systems Ltd  
Binzackerstrasse 41 · CH-8620 Wetzikon  
Switzerland  
Phone +41 44 933 64 64 · Fax +41 44 933 64 65  
www.legic.com · info@legic.com  
Designer and manufacturer of 13.56 MHz  
contactless smart card technology (read/write chip  
sets, security modules and transponder chips)

**Time + Access**



**wanzl**  
Zutrittskontrollen

Wanzl Metallwarenfabrik GmbH  
Bubeshheimer Str. 4 · 89340 Leipheim · Germany  
Tel. +49(0)8221/729-6416  
Fax +49(0)8221/729-90416  
zutrittskontrollen@wanzl.de  
www.wanzl-zutrittskontrollen.com  
Personal guidance systems, barriers, security  
turnstiles, electronic entrance systems

**Fire Protection**



**HEKATRON**  
Ihr Partner für Brandschutz

Hekatron Vertriebs GmbH  
Brühlmatten 9 · 79295 Sulzburg  
Tel. +49(0)7634/500-0 · Fax +49(0)7634/6419  
info@hekatron.de · www.hekatron.de  
Fire alarm systems, Smoke switch systems,  
Smoke alarms, Safety linkage systems

**Time + Access**



**MIDITEC**  
SECURITY SYSTEMS

MIDITEC Datensysteme GmbH  
Anne-Conway-Str. 5 · D-28359 Bremen  
Tel. +49(0)421-175 81-0  
Fax +49(0)421-175 81-30  
info@miditec.de · www.miditec.de  
hardware and software for access control, visitor  
administration, time recording

**Fire Protection**



**Kidde**  
A UTC Fire & Security Company

Kidde Brand- und Explosionsschutz GmbH  
Harkortstraße 3 · 40880 Ratingen  
Tel. +49(0)2102/5790-0 · Fax +49(0)2102/5790-109  
info@kidde.de · www.kidde.de  
Fire detection and extinguishing technology ·  
high sensitive smoke detection · fire protection  
systems for server cabinets and IT rooms ·  
explosion suppression systems · Explosion venting

**Fire Protection**



**NOTIFIER**  
by Honeywell

Notifier Sicherheitssysteme GmbH  
Berliner Str. 91 · D-40880 Ratingen  
Tel. +49(0)2102/70069-0 · Fax +49(0)2102/70069-44  
info@notifier.de · www.notifier.de  
fire alarm systems, early fire detection

**Time + Access**



**pcs**

PCS Systemtechnik GmbH  
Pfälzer-Wald-Straße 36 · 81539 München  
Tel. +49(0)89/68004-550 · Fax +49(0)89/68004-555  
intus@pcs.com · www.pcs.com  
time recording, access control, BDE/MDE, biometric,  
video, SAP, Infor-Baan

**Fire Protection**



**C-TEC**

C-TEC (Compuionics Limited)  
Stephens Way, Wigan, WN3 6PH United Kingdom  
Tel. +44(0)1942/403810 · Fax +44(0)1942/829867  
sales@c-tec.co.uk · www.c-tec.co.uk  
Fire Panels, Fire Alarm Accessories, Voice Alarm  
Systems, Fire Telephone Systems, Call Systems,  
Power Supplies

**Fire Protection**



**STÖBICH**  
FIRE PROTECTION  
Investment for your Protection

Stöbich Brandschutz GmbH  
Pracherstieg 6 · 38644 Goslar · Germany  
Tel.: +49 (0) 53 21 / 57 08 - 0  
Fax: +49 (0) 53 21 / 57 08 - 991  
info@stoebich.com · www.stoebich.com  
• Textile fire and smoke protection closures  
• Flexible and static smoke barriers  
• Conveyor system closures  
• Control units and 400-volt-emergency backup systems  
• Fire protection hoods for electric devices

**Time + Access**



**phg**  
Die richtige Verbindung

phg Peter Hengstler GmbH + Co. KG  
Dauchinger Str. 12 · D-78652 Deißlingen  
Tel. +49(0)7420/89-0 · Fax +49(0)7420/89-59  
datentechnik@phg.de · www.phg.de  
RFID components for access control, timekeeping, factory  
data collection, canteen data, leisure applications, surface-  
mounted devices, flush-mounting components, biometrics,  
identification media and accessories

**Be Part of the Section**



**GIT BUSINESSPARTNER**  
The Purchasing Section for direct contact

**Just send a mail to**  
**heiko.baumgartner@wiley.com**

**We will be glad to advise you!**

**Fire Protection**



**Teckentrup**  
Türen · Tore · Zargen

Teckentrup GmbH & Co.KG  
Tel. +49 (0) 5246/504-0  
Fax +49 (0) 5246/504-30  
www.teckentrup.biz · info@teckentrup.biz  
Safety doors, fire protection doors, noise control  
doors, smoke protection doors, fire protection gates

**Time + Access**



**primion**  
Integrated Security Technology

primion Technology AG  
Steinbeisstraße 2-4 · D-72510 Stetten a.K.M.  
Tel. +49(0)7573/952-0 · Fax +49(0)7573/92034  
info@primion.de · www.primion.de  
Time management, access control and  
management, staff deployment planning,  
graphic alarm management, SAP communications  
solutions, pass and ID card production, Biometrics

**Fire Protection**



**JOO**  
detectomat

detectomat GmbH  
An der Strusbek 5 · D-22926 Ahrensburg  
Tel. +49(0)4102/2114-60  
Fax +49(0)4102/2114-670  
info@detectomat.de · www.detectomat.de  
Fire alarms, Fire warning systems, Fire protection,  
security systems

**Fire Protection**



**ESSER**  
by Honeywell

Novar GmbH a Honeywell Company  
Dieselstraße 2 · D-41469 Neuss  
Tel. +49(0)2137/17-600 · Fax +49(0)2137/17-286  
info@esser-systems.de · www.esser-systems.de  
Fire alarm systems, security systems

**Time + Access**



**traka**

TRAKA-KeyManagement  
Leibnizstr. 3 · 53498 Bad Breisig  
Tel. 02633/200 360 · Fax 02633/200 361  
info@traka.de · www.traka.de  
Network-based key management to satisfy the  
strictest security requirements.

**Fire Protection**



**WAGNER**

WAGNER Group GmbH  
Schleswigstraße 1-5 · 30853 Langenhagen  
Tel. +49(0)511/97383-0 · Fax +49(0)511/97383-140  
info@wagner.de · www.wagner.de  
Hamburg · Berlin · Leipzig · Hannover  
Mülheim/R. · Frankfurt · Stuttgart · München  
Fire alarm systems and extinguishing technology,  
fire prevention, integral security

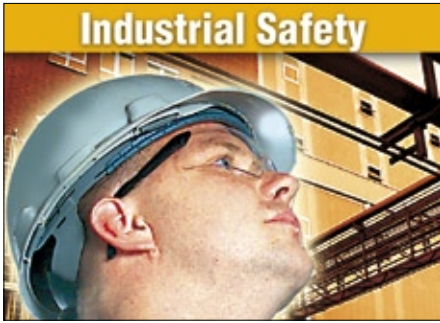

**Industrial Safety**

Evac+Chair International Ltd  
Tel +44 (0)121-706-6744  
www.evacchair.co.uk · info@evacchair.co.uk





European Training Division  
c/o ESE International BV, DG Veldhoven  
Tel. +31 (0)402553700  
Tel. +49 (0)6238 984 6810 (Germany)  
info@ese-int.nl  
Evac+Chair Training Solutions

**Hazardous Goods**



DÜPERTHAL Sicherheitstechnik GmbH & Co. KG  
Mainparkstr. 6-10 · 63801 Kleinostheim  
Tel. 0 60 27 / 403-0 · Fax 0 60 27 / 403-121  
info@dueperthal.com · www.dueperthal.com  
Fire protection rooms, hazardous materials storage,  
safety cabinets, environmental safety, fire protection

**Plant Safety**

More than safety. 

**EUCHNER**

EUCHNER GmbH + Co.  
Kohlhammerstraße 16  
D-70771 Leinfelden-Echterdingen  
Tel. +49(0)711/7597-0 · Fax +49(0)711/753316  
www.euchner.de · info@euchner.de  
Automation, safe and secure operation of machines,  
safety systems

**Be Part of the Section**

**GIT BUSINESSPARTNER**  
The Purchasing Section for direct contact

**Just send a mail to**  
**heiko.baumgartner@wiley.com**

**We will be glad to advise you!**

**Hazardous Goods**



Köttermann GmbH & Co KG  
Industriestr. 2-10 · 31311 Uetze/Hänigsen  
Tel. +49(0)5147/976-0 · Fax +49(0)5147/976-844  
systemlabor@koettermann.de  
www.koettermann.com  
Hood equipment, laboratory furnishings, media  
connections (supply and disposal)

**Plant Safety**



Pepperl+Fuchs GmbH  
Lilienthalstraße 200 · 68307 Mannheim  
Tel. 0621/776-1111 · Fax 0621/776-27-1111  
fa-info@de.pepperl-fuchs.com  
www.pepperl-fuchs.com  
Security sensors, inductive, capacitive, opto-  
electronic and ultrasonic sensors, vision sensors,  
identification systems, interface modules



**Dear Readers,**  
**Who is Who in Security:**  
BUSINESSPARTNER is the purchasing section of qualified companies for direct contact. Under the supplier's logo you will find the company name, telephone number, fax, e-mail, web address and the core competence.

**BUSINESSPARTNER on the internet:**  
**www.PRO-4-PRO.com/security.** There you will find all companies as well – with links to their websites. You belong to the most qualified suppliers as well and set great store by 20,000 opinion leaders reaching with each print issue?



COMPANY	PAGE	COMPANY	PAGE	COMPANY	PAGE
Abus Security-Center	45	Fujinon Europe	Outside Back Cover	Prymos	12
ADT Security	16	G4S Security Services	6	Rassegne	26, 34
AG Neovo Technology	14	Genetec	6	RSI	69
Apollo Fire Detectors	63	Geutebrück	24, 46	S. Siedle & Söhne	17
Arecont Vision	5	HDcctv Alliance	36	Salto Systems	44, 64
Assa Abloy Sicherheitstechnik	17	Hekatron	13	Samsung Techwin	9, 14, 44, 45, 48
Avigilon	45	HSM	59	Sanyo Europe	60
Axis Communications	15, Inside Front Cover	iCognize	17	Georg Schlegel	10
AxxonSoft	15	IndigoVision	55	K.A. Schmersal	10
Basler	15, 41, 44, 50	Ing.- Büro Rosin	18	Secura Systems	7, 40, 58
Baumer IVO	10	Interflex Datensysteme	16	Securiton	13
Bosch	7, 12, 16, 19, 46, 47, 66	IQinVision	44	SeeTec	14, 46, Front Cover
C-Tec	6, 13, 29, 69	Jerra Soft	33	Senstar	6
Capital Safety	18	Kentec Electronics	69	Sick	10, 30, Front Cover
CEM Systems	43	Kötter	18	Sicurit	49, 61
Communication Networks	44	Krealux	12	Siemens	16, 27, 46, 48
Compur Monitors	19	L-3	69	SimonsVoss	17, 67, 68
Contrinex	10	Legic	62	Sony	52
Dallmeier electronic	15, 37, 44, 56	March Networks	6	SpanSet	19
Deister electronic	3	Milestone Systems	14	Stöbich Brandschutz	13, 28
Detectomat	53	Mintron Enterprise	69	Tamron	57
Drägerwerk	18	Nedap	45, 47	Telefunken	20, 66
Duran Group	19	Nice	7	UTC Fire & Security	17
Enecsys	12	Norbain	6, 69	Uvex	19
Epoc Messe Frankfurt	11	Novar Esser by Honeywell	12	Viasys	7
EverFocus Electronics	15, 47	Panasonic	15, 23, 35	Videor E. Hartig	47
Eyevis	22, 65	Pelco	6	Vivotek	43
Feig Electronic	16	Pepperl + Fuchs	10	Wilbert Group	62
FFT Future Fibre Technologies	6	Pivot3	14, 46	Xtralis Phy	69
FireDos	13	Pixim	32	Zweibrüder Optoelectronics	18

## IMPRINT

### Published by

G.I.T. VERLAG Publishing Ltd.  
Roesslerstrasse 90  
64293 Darmstadt · GERMANY  
Tel: +49 (0) 6151 8090 0  
Fax: +49 (0) 6151 8090 144  
info@gitverlag.com · www.gitverlag.com

### Managing Directors

- Dr. Michael Schön
- Bijan Ghawami

### Publishing Directors

- Dr. Heiko Baumgartner  
Tel.: +49 (0) 61 51/80 90 137  
heiko.baumgartner@wiley.com

### • Steffen Ebert

- Tel.: +49 (0) 61 51/80 90 130  
steffen.ebert@wiley.com

### Sales Managers

- Regina Berg-Jauernig  
Tel.: +49 (0) 61 51/80 90 149  
regina.berg-jauernig@wiley.com
- Katina Leondaris  
Tel.: +49 (0) 61 51/80 90 107  
katina.leondaris@wiley.com
- Dr. Michael Leising  
Tel.: +49 (0) 36 03/89 31 12
- Manfred Höring  
Tel.: +49 (0)61 59/50 55

### Editorial

- Matthias Erler  
Tel.: +49 (0) 6723/9 94 99 82  
matthias.erler@wiley.com

### Editorial Assistant

- Nina Wehle  
Tel.: +49 (0) 61 51/80 90 214  
nina.wehle@wiley.com

### Production

- Christiane Potthast
- Andi Kettenbach (Layout)
- Claudia Vogel (Sales Administrator)

### European Representatives

- Dave Harvett, Direct Media  
Tel: +44 (0) 121 705 2120  
daveharvett@btconnect.com
- Oliver Haines, Impressive Marketing  
Tel: +44 (0) 1743 369611  
impressive.marketing@virgin.net

### Bank Account

Commerzbank AG Darmstadt, Germany  
Account-No. 01.715.501 00  
(Routing No. 508 800 50)

GIT SECURITY is published 6 times per year.

### Subscription 2010

6 double-issues 72.00 €, single copy 14.50 € plus postage. Pupils and Students receive a discount of 50 % at sight of a valid certificate. Subscription orders valid until cancelled, notices 6 weeks before end of the year. Subscription orders can be revoked within 1 week in writing. Dispatch complaints are possible only within 4 weeks after publishing date.

The publishing house is granted the exclusive right, with regard to space, time and content to use the works/ editorial contributions in unchanged or edited form for any and all purposes any number of times itself, or to transfer the rights for the use of other organizations in which it holds partnership interests, as well as to third parties. This right of use relates to print as well as electronic media, including the Internet, as well as databases/data carriers of any kind.

All names, symbols etc. mentioned and/or printed in this issue may be registered trademarks of their respective owners.

Printrun: 20,000 (1st quarter 2009)

### Cover Page Layout

Elli Palzer · elke.palzer@wiley.com

### Printed by

pva Druck und Mediendienstleistungen GmbH  
D-76829 Landau/Pfalz

Printed in Germany  
ISSN 2190-4367



**Long range for  
better security.**

**NEW D60x16.7SR4D-V41**

f = 16.7 ~ 1000 mm (1x)

f = 33.4 ~ 2000 mm (2x)



Please visit us in Essen  
Security, Hall 2.0 Booth 232  
October 5–8, 2010



[www.fujinon.de](http://www.fujinon.de)

Medical TV **CCTV** Machine Vision Binoculars



**MP**<sup>MEGA</sup>  
PIXELS

With a resolution of 2 megapixels and a 60x optical zoom the Fujinon D60x16.7SR4D-V41 offers new and innovative perspectives in security. This fast tele-zoom lens delivers high-resolution pictures in HD quality and – thanks to the 2x extender – covers focal lengths from 16.7 mm all the way up to 2000mm. All these features combined make this

lens the first choice for long distance surveillance, i.e. at airports, harbours or border crossings. Thanks to Fujinon's day/night technology, even the smallest details can clearly be seen and identified over long distances around the clock. This means that your surveillance system will provide better security than ever before. Fujinon. To see more is to know more.