

79 824

Volume 7

March 2011

GIT

EMEA Edition

SECURITY

MAGAZINE FOR SAFETY AND SECURITY

2



Perimeter Protection

Homeland Security

Security for the Public Sector

Fire Detection

Airport Security

COVER: Milestone



milestone

The Open Platform Company

GIT VERLAG

A Wiley Company

The WiseNet2 DSP chipset with Full HD

Capturing every detail



iPOLiS **FULL HD** **ONVIF**
Driving network video through global standardisation

WiseNet II

H.264 Compression

Smart Codec

Up to 3 megapixel (2048 x 1536) and Full HD (1920 x 1080p) resolutions supported

Wide Dynamic Range

Samsung Super Noise Reduction

Net-i viewing software

Hybrid dual Ethernet and BNC outputs

Built in SD card slot

Power over Ethernet (PoE)

Progressive Scan

Full 1080p High Definition (HD) has arrived with the SNB-7000

The SNB-7000 is the first of a new generation of iPOLiS megapixel cameras featuring the Samsung WiseNet2 DSP chipset and capable of delivering Full HD (1080p) resolution images.

The WiseNet2 DSP chipset brings a host of advanced functionality to your security application whilst minimising bandwidth requirements. For example, the inclusion

of Samsung's Smart Codec allows you to highlight critical areas within a scene which can then be transmitted at a higher frame rate than the rest. When coupled with high level H.264 compression and the option to simultaneously stream a variety of resolutions, including Full HD (16:9 format) and up to 3MP (4:3 format) images, the user is put firmly in control of how images are managed.

Wide Dynamic Range delivers a well balanced image in scenes with high light and dark contrasts whilst third generation Samsung Super Noise Reduction (SSNR III) eliminates

image noise in low light conditions to greatly improve image quality and reduce bandwidth and recording space requirements.

Offering seamless integration with Samsung's range of standalone network video recorders, NET-i recording software and license-free NET-i viewing software, the SNB-7000 is also fully ONVIF compliant and compatible with a host of leading third-party video management platforms.



IFSEC 2011

16-19 May 2011
 NEC Birmingham, UK

SAMSUNG CITY | 5/D130

T +44 (0)1932 455 308
E STEsecurity@samsung.com
W samsungsecurity.com

Samsung Techwin Europe Ltd. Samsung House,
 1000 Hillwood Drive, Chertsey, Surrey, KT16 0PS, UK



Think Outside the Box

When you had a first look at our front cover, you may have asked yourself what surfing has to do with safety and security. A closer look at our cover story explains everything: The usage of video surveillance for the safeguarding of beaches is a clever thing. The idea is a good example for thinking out of the box, but the company who invented the system did not stop here. Watching the world's coastlines with high-tech eyes for safety reasons was not enough. They use the system also to inform surfers about the conditions on the ground and to help them to have more fun with their sports. People living in houses close to the coastline benefit also from information and data about possible dangers delivered by the system.

There are other examples where the use of equipment for its traditional purpose can be extended. In the retail business the use of video surveillance cameras to protect retail shops is standard, but by using intelligent cameras or the appropriate software you can collect valuable information about how many people come to a store and which areas are most frequently visited. To think outside of the box here helps you to get more value out

of your investment. If you plan to install surveillance cameras, why not invest some more money into intelligent systems that provide you with video analytics tools like virtual trip wires and deliver you not only a standard CCTV application but also a modern alarm system.

We have shown in several articles how thermal cameras can be helpful tools for video surveillance and to protect perimeters. But again: Think out of the box. The same technology can be used for fire protection. The article in this issue illustrates how thanks to their ability to measure temperatures in a non-contact mode,

they can also easily be used for fire prevention. They can detect hot spots and prevent them from turning into a fire.

When you take some time to have a look at this issue you will easily find more ideas and new product developments that help you with your daily business. Within and outside of the box.

Enjoy reading this issue!

Heiko Baumgartner

www.GIT-SECURITY.com

REGISTER NOW for our
free NEWSLETTER

My Access to my Business.



**LEGIC advant[®]
4000**
Reader chip series

- Multi standard
- Low power
- Upgradable

NEW

**Any service I can imagine,
any security level I desire.**

**All on one chip. On the
credential of my choice.**

Contactless smart card
technology: www.legic.com

LEGIC[®]
innovation in ID technology

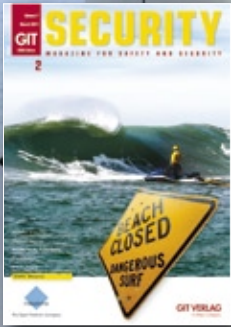

26

SECURITY

Watching Coastlines Via the Cloud

Coastalwatch Safeguards Shorelines and Popular Beaches with Hosted Milestone Video

10

INTERVIEW

2011: A Cornerstone in Samsung's Security Business

An Interview with Lucas Lee, from Samsung Techwin Europe

16

AIRPORT SECURITY

Hands Up!

A Close Look at People Screening Products – Part 2

20

MANAGEMENT SOLUTIONS

Intuitive Control

Rolling Multiple Management Systems into One Human Interface

EDITOR'S NOTE

Think outside the box
Heiko Baumgartner

MANAGEMENT

EVENT

Share Experience and Gain Knowledge
Counter Terror Expo 2011 in London

INTERVIEW

2011: A Cornerstone in Samsung's Security Business
An Interview with Lucas Lee, the New Managing Director for Samsung Techwin Europe

SECURITY FOR CHEMICAL INDUSTRIES

Tailwind with a Parachute
Security Solutions for the Chemical and Pharmaceutical Industries

AIRPORT SECURITY

3

Hands Up!

A Close Look at People Screening Products – Part 2

16

SECURITY

8

PERIMETER PROTECTION

The Improved Garden Fence
A Video Surveillance Upgrade Reduces Losses

18

MANAGEMENT SOLUTIONS

Intuitive Control
Rolling Multiple Management Systems into One Human Interface

10

20

SECURITY FOR PUBLIC SECTOR

Going Keyless on Campus at Westminster
Increased Security and Ease of Accessibility in a Central London College

12

22

Passed the Test

Walsall Academy Upgrades to a Powerful Hybrid Surveillance System

24

COVER STORY

Watching Coastlines Via the Cloud
Coastalwatch Safeguards Shorelines and Popular Beaches with Hosted Milestone Video

26

Stadium Safety and Security Is Custom-made

How to Meet the Security Challenges of Sports Stadiums and Entertainment Facilities

28

ACCESS CONTROL

Getting Hip
Considering the Transition from Analog to IP-based Surveillance

30

CAMERA TEST

Test the Best!
In Focus: Bosch NDN-498

32

In Focus: Ganz ZN-DWNT 350VPE

33

CCTV

The Most Secured Building in the Country
High Security in the Palmares Technologies Building

35



36

SECURITY FOR HOTELS AND CASINOS

Surefire Winners
Germany's Most Modern Casino – Also Right Up-to-date in Security Technology



38

CCTV

Small, Smart, Green
How hard- and Software Interact in an Optimal Way – our Interview with Dieter Dallmeier



44

FIRE DETECTION

Sun without the Burn
Modern Fire Detection Technology Provides Safety in Solar Valley

Small, Smart, Green

How hard- and Software Interact in an Optimal Way – our Interview with Dieter Dallmeier

38

SECURITY FOR HOTELS AND CASINOS

Surefire Winners
Germany's Most Modern Casino – Also Right Up-to-date in Security Technology

36

FIRE PROTECTION

FIRE PROTECTION

Hot, Hotter, Hottest

Thermal Imaging Camera Detects Potential Fires at a Very Early Stage

42

FIRE DETECTION

Sun without the Burn

Modern Fire Detection Technology Provides Safety in Solar Valley

44

SECTIONS

News	6
Security Products	34, 40
Fire Protection Products	43
Business Partner	46
Company Index/Imprint	51

Touch



me!

The new system management console **Pilot** – intuitive operation, intelligent touch-keys, modular components for right and left handers and and and. **Pilot** – looks good, feels good – Touch it! www.geutebrueck.com

GEUTEBRÜCK
Competence in Video Security

Beograd Airport Integrates Biometric eGate Solution

Since 22nd December 2009 Serbia is officially a pre-accession country for the European Union (EU). An important step to reach is aim is the setup of a state-of-the-art ID infrastructure with latest technology and a highest level of security. After the introduction of new ID cards and ePassports, the first electronic border-crossing gate, called e-Gate, was opened this week at Beograd Airport by the Serbian Ministry of the Interior, Mr. Ivica Dačić. By implementing eGate, Serbia starts a test phase for fully automatic border control processes at their airports. Muehlbauer Group, who delivered already the turnkey solutions for the countrywide ID card and e-Passport project in 2007 and 2008, supplied the gate. The gate itself is one of the first e-Gates worldwide, able to read-out biometric fingerprints, which are secured by the European EAC (extend access control) standard. Serbian citizens can use this gate with their new passport to pass the border control without presenting their ID document to a border official.

wolfgang.wanner@muehlbauer.de

EU Standard 3 Approval for L-3 Explosives Detection System

L-3 Security & Detection Systems announced that its Examiner XLB explosives detection system (EDS) has passed the European Union Commission Regulation Standard 3 for Aviation Safety under the European Civil Aviation Conference (ECAC) Common Evaluation Programme of Security Equipment (CEP). The system was successfully tested by the Service Technique de l'Aviation Civile (STAC), the engineering department of France's aviation regulatory agency. The detection system is the first high-speed CT EDS to achieve EU Standard 3 approval under the new CEP and delivers operational throughput greater than 1,200 bags per hour.



"The Examiner XLB is the highest-performing in-line CT EDS available and the only EU Standard 3 system with sufficient throughput for European Level 1 operation," said Thomas M. Ripp, the company's president. "We continue to invest in the Examiner platform to meet current and future EU standards."

www.L-3com.com/sds

Sypris and Cassidian Form International Strategic Alliance

Sypris Electronics has signed a Technology Information Exchange Agreement (TIEA) with Cassidian, formerly known as EADS Defence & Security. The TIEA will enable the global leverage of mutual capabilities in several critical information assurance areas, including key management, secure communications, and cyber security. Specifically, the TIEA between Sypris Electronics and Cassidian allows the Companies to expand their market reach for existing information assurance hardware and software solutions, by utilizing new domestic and international sales channels. This agreement gives both companies an opportunity to round out their respective portfolios as they relate to global information assurance. "For years, Sypris and Cassidian have protected the most classified data and networks in the world," stated John Walsh, President of Sypris Electronics. "This agreement allows access to best-in-class technologies, which will help both organizations to launch new secure, robust, and comprehensive security solutions that will benefit the U.S. Government, International Ministries of Defence, and aerospace and defense contractors worldwide." Doug McGinn, VP of Security Solutions at Cassidian, said: „This relationship provides a unique opportunity for our companies to work together and leverage our products and capabilities to address the growing need for information security across the global cyber domain."

communications@cassidian.com

Apollo Signs up for National Defence

Apollo fire detection technology has been chosen to protect a major Australian Army base; Blacktown 200 Man Camp at Robertson Barracks near Darwin, Australia. The contract for the fire detection was awarded to Ampac Technologies. Blacktown 200 Man Camp forms part of Robertson Barracks in Australia's Northern Territory. Built in 1995, the Barracks are home to the 1st Brigade and the 1st Aviation Regiment. The 1st Brigade is the Australian army's light armored brigade, consisting of more than 3400 civilian and military personnel. The 5,000 m² Blacktown camp required a fire detection system that could reliably protect personnel occupying its large number of accommodation rooms, amenities and common rooms. As the camp includes sleeping accommodation, it was important to minimize false alarms. Ampac supplied a fire detection system based around its Firefinder 10 loop panel, incorporating 270 Apollo XP95 smoke and heat detectors and 220 integrated sounders. The fire system is configured into zones made up of eight or 16 rooms. In the event of an emergency, each zone and will sound individually and not cascade, whilst the amenities and common rooms are also zoned and sound individually.



www.apollo-fire.com

Gunnebo: New Security Group Executive Team

Mats Johansson (left) has been appointed SVP Operations, responsible for Gunnebo's global industrial platform and includes the responsibility for all production, logistics, purchasing, research and development, and environmental and quality work in the Group. He is currently Country Manager Gunnebo China, based in Shanghai, which is a position he will also keep going forward. He has years of experience in production as well as within research and development from companies such as Fagerhult, IMI Plc and Uponor. Tomas Wängberg (right) was Appointed SVP Developing Businesses. He has been a member of the Group Executive Team since 2009 in his positions as SVP Business Area Secure Storage and SVP Operations. Since February 10, he will have the positions SVP Business Area Secure Storage and SVP Developing Businesses, the latter including overall responsibility for the three units comprising Developing Businesses: Gateway, Perimeter Protection and SafePay.



www.gunnebo.com

Fluidmesh and Lensec Enter Technology Partnership

Fluidmesh Networks and Lensec have entered into a technology partnership. With their combined technologies the companies want to provide security integrators with an enhanced surveillance solution. Fluidmesh is an innovator in wireless systems and offers solutions spanning point-to-point, point-to-multipoint, and mesh networks. Lensec is renowned for its advanced software systems and custom integration services with easy-to-use web-based tools. The company's flagship software product, Perspective VMS, is a Smart Client solution for Integrated Security Management delivering surveillance, collaboration, and post-event forensic analysis. Cosimo Malesci, vice president of channel sales & marketing for Fluidmesh, notes that "Lensec's Perspective VMS is exceedingly innovative software. Its platform represents the next evolution of smart-client video monitoring and investigative software and it works beautifully with Fluidmesh technology. Together, we can provide customers with superior wireless solutions for their video surveillance installations."

www.fluidmesh.com

Bosch Loudspeakers at Tüdemsas Railway Machinery

Established in 1939, Tüdemsas (Turkish Railway Machines Industry Inc.) repairs freight and passenger wagons and manufactures freight wagons and spare parts. Its factory in Sivas, Turkey has a total area of 287,467 m² with an additional indoor area of 96,000 m². The factory employs 1,500 people, making it one



of the biggest industrial groups for the international railway market in the Adriatic Region and the Middle East. Between January and April 2010, solutions supplier and Bosch dealer Entegre Electronics from Istanbul designed and installed a public address and evacuation system at Tüdemsas, based around 50 Hemi-directional Loudspeakers from Bosch. The loudspeakers were installed in three buildings and cover around 50,000 m². The public address and evacuation system is controlled and managed from the factory's head office and security center. Business calls and emergency announcements can be made from both locations. The security center uses call stations with keypads. For the head office Entegre Electronics designed PC-based call stations with a graphical user interface that enable on-screen zone selection and both pre-recorded messages and live speech in the selected areas.

www.boschsecurity.com

Brickcom IP Cameras Integrated with Milestone XProtect

Brickcom Corporation announced the complete integration of a wide range of their IP camera series with Milestone X-Protect open platform IP video management software. Customers will now be able to integrate the clear definition video from Brickcom IP cameras with the high quality of the IP video management software. With the Milestone X-Protect Device Pack 5.2 that was released at the end of December 2010, users are now able to operate wired and wireless models of Brickcom's Cube, Fixed Box, and Fixed Dome IP cameras with their Milestone X-Protect Enterprise, Professional, Essential, Go, and Corporate systems. The Brickcom Cube, Fixed Box, and Fixed Dome series are equipped with high-resolution sensors and H.264 video compression to deliver the highest quality video and efficiency. With a wide range of features including two-way audio support and Power over Ethernet, Brickcom IP cameras are also easy to install.

www.milestonesys.com

Panasonic Strengthens Irish Security Solutions Team

Panasonic System Networks Europe announced the appointment of John Phelan as Panasonic Ireland Area Sales Manager. He brings to Panasonic an 11-year history in Security Installation management coupled with industry driven determination and comprehensive security qualifications. Phelan's initial focus will be on the development of the company's Security group within dealerships, specifiers, end users and installers. Evolving from an education in Business Management and IT, John moved into the security distribution business with Liam Phelan in 1999. Subsequent years in the ever growing Phelan Security provided John with huge experience working with major manufacturers, including Panasonic, and across all areas of the security industry. Recognizing that the market for IP was growing, John decided to embark on a series of educational programs with the aim of developing expertise in all areas of IP and networking; Gaining Cisco's CCNA and Comptia's Network Plus qualifications. John was one of the early pioneers of IP into the Irish market, and it was then that he decided the future of CCTV was in IP technology and High Definition video.

www.panasonic.co.uk/cctv



CBC Boosts Customer Support

Leading surveillance solutions provider CBC (Europe) has created a new Customer Support Manager role, providing a dedicated one-stop link between its customers and a wide range of support functions. With this move the company wants to ensure that buyers of brands including Ganz and Computar – including installers, end users, and consultants – will continue to get the best possible help with their requirements, ranging from quotations, to order queries and technical questions. Filling this new post, the company has recruited David Cooper, who brings wide-ranging customer support experience to the role. "David's appointment is yet further proof of our commitment to our customers," says John Downie, National Sales & Marketing Manager for CBC (Europe).

www.cbucuk.com

Nedap AVI: New Business Development Manager Russia and Eastern Europe

Nedap AVI announced the further strengthening of its team through the appointment of Edwin Siemerink as Business Development Manager for the Russian and East European markets. Edwin Siemerink (43) joined the company in December 2010. He is no stranger to the security world having set-up his own security business in 2002 specializing in alarms for people and objects. "Our focus is now on achieving significant growth in a number of target regions worldwide – Russia and Eastern Europe being one of these regions. With a dedicated sales representative for this market, we are now able to explore opportunities and offer our clients tailored solutions to suit their individual needs," comments Maarten Mijwaart, General Manager, Nedap AVI.

www.nedapavi.com



TSA Certifies Morpho Explosives Detection Solution

Morpho Detection announced its CTX 9800 DSI explosives detection system (EDS) has been certified by the Transportation Security Administration (TSA) in a high-speed configuration that processes in excess of 40 percent more bags than its fastest previously-certified system while continuing to provide high-resolution 3D imaging with the innovative data acquisition system, Clarity. The system offers operators the possibility of reduced operational costs through simplification of baggage handling infrastructure, reduced maintenance requirements and fewer manual alarm resolutions, while speeding more cleared bags to aircraft faster. Dennis Cooke, president and CEO, Morpho Detection: "Approval of this new, faster CTX 9800 offers airports the flexibility to meet competing demands of customer requirements, space and budget while controlling operational costs."

steve.hill@morphodetection.com

Sicherheitsexpo 2011 Growing Rapidly

The 8th Sicherheitsexpo 2011 at ICM, International Conference Center Munich from July 6th to July 7th 2011 is almost fully booked. Only a few spaces are left of the exhibition space of 5,500 square meters. The exhibition will be the most important trade fair of security technology in Germany 2011. The number of exhibitors will increase of about 30 percent to a total of approximately 150. The event's program covers fire protection and alarm facilities; video surveillance and entrance control systems; mechatronic security doors, windows and security glasses; perimeter protection; IT- and network security programs. The target group of the trade fair includes security managers from police, fire brigades, industry, transport, wholesale and banks; security services and resellers; facility managers, security consultants, insurances and construction companies.

www.SicherheitsExpo.de

EVENT

Share Experience and Gain Knowledge

Counter Terror Expo 2011 in London

Counter Terror Expo 2011 will be held within the Grand Hall of London Olympia from 19–20 April 2011. The annual event for professionals tasked with the complex role of addressing the challenging terrorist menace, takes place against the backdrop of an increasingly potent threat to public safety. With the intelligence community signalling an intent or desire amongst extremist groups to target crowded places as well as the international transport network, the two day Counter Terror Expo 2011 event sits at the epicentre of the global effort to disrupt or deter such attacks.

Established with the intent to deliver an environment in which professionals within the critically important counter terrorism arena can come together to share experience and gain knowledge, the event has grown to be a truly key gathering of the leading experts in the field from within government, military, the security services, law enforcement, and academia worldwide.

Counter Terror Expo features a highly relevant centrepiece conference designed to deliver insight, analysis and perspective to current threats. Counter Terror Expo 2011 offers the chance to see over 400 exhibiting companies and hundreds of products dedicated to counter terrorism and the specialist security arenas. The large-scale programme of free-to-attend educational sessions and high-level conferences complement the exhibition and ensures that Counter Terror Expo offers something for everyone. Visitors can meet an array of companies and learn about which products and services can assist in countering the global terror threat. Full details on all the Counter Terror Expo exhibitors can be found at www.counterterrorexp.com/exh.

The Counter Terrorism and Specialist Security Industry Awards

Organised by BDEC and headline sponsored by Counter Terror Expo, the awards will run on the 19th of April at the Royal Garden Hotel in Kensington, and the awards will applaud excellence and achievement. For more information on entering or attending the awards, please visit www.ctssawards.com.

Workshops

An extensive and highly specialised programme of workshops has been developed to offer an in-depth examination of specific issues and provide a focused forum for debate, and the showcase exhibition is one of the largest of its kind anywhere.

Extended Conference Programme

EU Counter-Terrorism Coordinator Gilles de Kerchove, made a prescient call for better sharing of information to stop potentially dangerous travellers in August. "What is worrying us the most is extremists entering Europe, people who



were born here or who have one of our member states' passports, who can therefore slip under the police and intelligence radar," he told the euronews television channel at the time. He added that while Europe has agreements in place for tracking financial transactions, it really must have a similar system in place to collect information on passenger movements.

- "Preventing & Combating Global Terrorism – 10 years on from 9/11," is the principal Counter Terror Expo 2011 conference theme exploring many of the issues that these two events have exposed publicly. Gilles de Kerchove's comment came in the wake of the US government and others warning citizens of the possibility of terrorist attacks in numerous European countries. Travellers were warned of the threat to transport networks and public spaces and told to be on their guard. The warning has been renewed, albeit in lower key fashion, following receipt of intelligence described as credible from Iraqi government sources in the aftermath of the events in Stockholm. Protection for public spaces and mass transit systems, present the counter-terrorism and law enforcement communities with an enormous challenge. This conundrum has been explored in depth over a long period of time and the risk based approach remains the only operationally viable and publicly acceptable solution, but supported by advanced surveillance and target hardening techniques that enhance safety but don't impede on the every day lives of the public.
- "Achieving Homeland Security In The Face Of The Terrorist Threat" is a core Counter Terror Expo 2011 theme examining strategies adopted in the United Kingdom and the United States of America. Other key conference themes focus in on the primary methods adopted to deliver the maximum public protection in public spaces and across the transport networks. The year to date has also been dominated by the near successful attempt

by Al-Qaeda in the Arabian Peninsula (AQAP) to down two cargo flights over the United States eastern seaboard with two powerful Improvised Explosive Devices (IEDs) concealed in airfreight. Both were being transhipped from the Yemen. The device discovered at East Midlands airport in the United Kingdom had already flown on two cargo aircraft, whilst the one found at Dubai airport in the United Arab Emirates had been shipped there as belly-hold cargo on two passenger jets.

- AQAP has become notorious during the past 18 months, for their audacious left of field attacks primarily against the international transport networks. In attempting to transship powerful explosive devices through the airfreight network, they were exploiting long known weaknesses in the security regime and could very easily have succeeded in their ultimate goal. It is instructive that the device discovered at East Midlands airport, was only identified as a credible and potent threat following a second examination prompted by additional information from overseas. This fact has prompted some searching questions about the effectiveness of regionally deployed explosive detection capability, when faced with carefully packaged and concealed threats. The Counter Terror Expo 2011 "EOD & IEDD" seminar brings valuable insight to the detection and deactivation and disposal of such dangerous weapons, through major presentations of the latest technologies to counter and contain such threats.

Counter Terror Expo's centrepiece conference is a multi-stream event featuring a mix of one and two day conferences and will cover six main areas. Details of the streams are shown below and the detailed programmes and speaker details can be found at www.counterterrorexpo.com/confprog.

▶ CONTACT

www.counterterrorexpo.com



large lenses.

ULISSE PLUS

The housing dimensions have been studied to easily fit medium-sized zoom lenses.

www.videotec.com

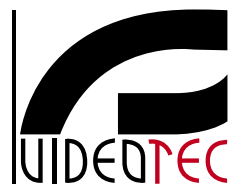

CCTV PRODUCTS
www.videotec.com

INTERVIEW

2011: A Cornerstone in Samsung's Security Business

An Interview with Lucas Lee, the New Managing Director for Samsung Techwin Europe

At the beginning of 2010 Samsung Techwin took over responsibility for the supply and support for both Samsung Techwin and Samsung Electronics electronic security product ranges. During 2010 Samsung worked hard to make the internal merger a success.

GIT SECURITY had the opportunity to ask Lucas Lee, the new Managing Director for Samsung Techwin Europe, about the progress they have made and their plans for the future.

GIT SECURITY: Mr. Lee, you have already worked within Samsung Techwin's professional security division before you were appointed as Managing Director of Samsung Techwin Europe Ltd. How was your start and how do you evaluate Samsung's position in the security industry?

L. Lee: I have actually been working for Samsung Techwin for over 15 years, and prior to the Security Solutions division being set up in 2008 I was working for the consumer camera business. Before this time security equipment was a product line we were involved in, but it was at a very modest scale compared to what we see today. When the security solutions division was formed I was made responsible for overseas sales and marketing, that is everything outside of Korea. Our focus was to become a full solutions provider and we focussed on using our R&D and manufacturing expertise to broaden our product portfolio into new areas such as DVRs, speed domes and iPOLiS network products – all of which were very well received in the market place. Then, more recently following the transfer of Samsung Electronics security business to that of Samsung Techwin, we have introduced Access Control, Door Entry and Intruder Detection products allowing us realise our goal of delivering complete security solutions. In terms of our position in the market place I believe we are



Lucas Lee, Managing Director for Samsung Techwin Europe

unrivalled in being able to deliver what the customer wants using the most advanced technology, which offers enhanced benefits over what our competitors can offer and better overall value. We listen very carefully to our customers and have the expertise to bring solutions to market very quickly – we are constantly improving and setting the benchmark for others to follow.

I can imagine that 2010 was a very busy year for Samsung. What has been achieved after the announcement of the internal merger and the plans for a combined product push last year?

L. Lee: Yes, a lot happened during 2010. Our security solutions team more than doubled in size globally and we introduced around 170 new products into a "single Samsung" portfolio following the transfer. As I mentioned earlier, we also introduced new business areas such as Access Control where we hadn't had an offering before so there has been a lot of work behind the scenes in ensuring we have the right people

and processes to support that kind of technology. I am pleased to say that we are already seeing major successes and as a single Samsung we have the resource and focus to achieve our goal of becoming the number one security brand.

With good success Samsung was putting a lot of R&D efforts into the development of analogue products in the past. Will that continue or will you shift your focus more to IP products in the future?

L. Lee: We are driven by the demands of our customers and, whilst keeping a leading position in analogue by focusing more on vertical applications, IP clearly offers a big opportunity for us. We can definitely say that 2011 will be the year of the network in terms of our product development. With Samsung having world leading expertise in both networks and security, we are well placed to ensure our next generation IP security solutions offer exactly what are customers want.

Last year at your Vision Day conference and the big trade fairs you were presenting Samsungs new access control products to the market. Will you continue to broaden your offering for this segment?

L. Lee: Absolutely yes. We have a full roadmap for our range of access control products this year as we look to bolster our offering. Access control plays an important part in our plans in developing total security solutions and the integration between video and access control in particular is something that we believe will be one of our major successes this year. We have successfully recruited Access Control specialists in product management, technical and sales to support our activity too.

Excellent products have always been a good basis for business, but customers tend to ask for more e.g. Full service packages, technical support, 24/7 service, etc. How do you cope with these demands?

L. Lee: We have always believed that we cannot be successful by providing only the best products and solutions alone, but we need to back it up with the best support packages too. We have had in place for some time a full three-year warranty across our product portfolio, pan-European service centres with a five-day repair turnaround promise in the event that something does go wrong and we are currently bolstering our technical support teams across Europe to ensure that the vast majority of our customers will have a local language contact to speak to about specific technical issues. We are also looking at new ways to service customers. Being a global business we can benefit from the resources we have across the world and we are currently building integrated global technical support systems to provide 24-hour coverage.

To sum up, what can we expect from Samsung in 2011?

L. Lee: I think better service, even better products and world-class solutions that not only improve the safety and security of people, but also deliver other business benefits. We will also be looking to add to our team, including the recruitment of quality assurance staff and additional Business Development Managers throughout Europe to ensure our products and solutions are brought to the attention of the widest possible audience. This year Samsung will place a cornerstone in its security business to become a leading total security solutions provider utilizing the benefits of business integration, leading digital technology and our strong brand power. It will definitely be an exciting year for us!

► CONTACT

Samsung Techwin Europe, Chertsey, UK
Tel.: +44 1932 455 308 · Fax: +44 1932 455 325
STSecurity@samsung.com

Samsung Vision Day 2011

Following a tradition, Samsung Techwin was inviting its partners to the annual Vision Day conference this year to give them the opportunity to discover firsthand what strategy Samsung has and what products are in the pipeline. This year the conference took place in Malta on March 3rd and 4th. The delegates used the opportunity to be among the first to see and have hands-on demonstrations of many of the new products to be launched this year.

During the conference Samsung made clear that in 2011 the company will put a strong focus on IP & Network solutions business and is looking to continue to increase its market share rapidly across Europe. "Integration is key", was mentioned in several presentations and speeches and Samsung aims to expand their "pull" marketing activity to reach more end-users, system integrators and installers across all territories and support each with their specific needs and requirements. As mentioned in the interview above, their new Managing Director Lucas Lee knows how important it is to expand the support and sales functions and to bolster the technical support and business development.



Yoonho Ha opens the Samsung Vision Day 2011



Also in 2011 Samsung will have a very active product introduction roadmap year, including the introduction of TSM-2000 (the Total Security Management solution), new robots (including the STAR mobile unit) and a host of IP/Network products and products from new business areas such as Access Control.

SECURITY FOR CHEMICAL INDUSTRIES

Tailwind with a Parachute

Security Solutions for the Chemical and Pharmaceutical Industries



Heiner Jerofsky
CID officer (ret'd)

The chemical and pharmaceutical industries have survived the commercial and financial crisis well. These companies are enjoying a strong tailwind behind their business and, through the strength of their innovations, have proven to be one of the workhorses of economic growth. The current prognosis for this year reckons with an increase of German chemical production of around 11 percent. The total turnover of the industry grew during 2010 by some 18 percent. The pharmaceutical industry in general, and above all the group of researching pharmaceutical companies, also show a stable economic development in the current business cycle. However, danger can lurk in many corners for these companies. Such sensitive systems and processes can be well protected and secured with the help of modern security solutions or emergency ‚parachutes‘. GIT SECURITY demonstrates suitable concepts and technology.

Intention and Situation

Handling chemicals and medicines demands a fundamentally higher safety standard than in other branches of industry. In spite of this, there are frequent events that cause loss, outages and operational stoppages and also cause damage to corporate image. It is increasingly important to protect the whole operation against theft, sabotage and attacks by using suitable safety and security concepts. The product palette of large organizations stretches from oil and gas through chemicals, plastics and finishing products up to pesticides, fine chemicals and important pharmaceutical products. Experts know that the ‚immobilization‘ of an important technical system, such as the energy supply, a high rack warehouse, a laboratory, the IT or a steam cracker, can lead to

delivery difficulties for numerous products and thereby cause significant financial damage.

Such core industries are the motor of our economy and simultaneously – according to the current criminal statistics – also a potential target for saboteurs, terrorists and other criminals. The EMEA region has long been a member of the ‚worldwide danger zone‘. This is no longer just an ‚abstract‘ threat, as the terrorist danger had long been rated. At the end of last year several terror warnings have been issued because attacks were considered to be possible in Europe. The security measures at airports and railway stations were increased drastically. This can happen anywhere as the Islamic extremist fighters know just how vulnerable our community is and change their strategies at will. There-

fore only coherent and flexible security concepts help to protect our important industries.

Analysis and Risks

A security analysis must be regularly carried out to evaluate the weak points and potential dangers for the company and its people that takes into account current risks and security hazards. This appraisal of the status quo should try to cover all security risks (realistic dangers and recognized weak points) according to the type of production, infrastructure, location of the company and the sensitivity of the production processes.

It is all about estimating the criminal damage caused by property crime, fraud, misappropriation of company funds, corruption, industrial espionage, competitive infringements, product piracy,



© af photo/fotolia.com

sabotage, product blackmail, bomb threats and felonies with a terrorist motivation. The threat arises from many very different sources and the risks for each company are constantly changing. To make such an evaluation it is necessary to draw on the statistics and experience of insurers, the police and also security service providers, and to be advised by (external) security specialists. Criteria are the likelihood of an event and the extent of the potential damage. Therefore, the higher the risk and its probability, the more urgent the need for action. It must also be decided whether the risks threaten the company's existence or rather would have no significant effect on the functioning of the operation. This type of report forms the basis for adapting the security concept.

Aims and Principles

The point of the exercise is quite simple: the highest security with the lowest (cost) effort! The vulnerabilities, threats and risks are minimized by technical, staff or organizational measures according to a list of priorities resulting from the security analysis. This, together with the security goals given by the company management, should contain primarily:

- the preservation of health of the employees and visitors,
- the protection of company equipment and know-how and thereby

- the commercial capability, the production capacity and supply capability of the company.

It is self-evident that the security concept must conform to all legal requirements. It takes into account the complete interaction of all security measures to date and should structure them as follows:

- perimeter protection (route and construction),
- personnel and vehicle access,
- protection of particularly endangered areas, buildings and systems,
- organization and equipment of the company security operation,
- danger warning systems and communications technology,
- measures for the prevention and clarification of crimes.

Perimeter Protection and Mechanics

The first and simultaneously one of the most important protective measures is consistent perimeter protection with sufficient distance from endangered buildings and systems. The simple formula for protection of buildings and systems is: first secure outside, then inside – first secure mechanically, then electronically. Fencing must of course be of the same quality right round the entire compound. Good open field security already protects objects

INNOVATION MOVES ON...

IFSEC IS EUROPE'S FIRST OPPORTUNITY TO SEE NEW SECURITY PRODUCTS BROUGHT TO LIFE

**ACCESS CONTROL | CCTV | INTRUDER ALARMS | IP/NETWORK SECURITY
PUBLIC SECURITY | SECURITY SOLUTIONS**

THE INTERNATIONAL SECURITY EVENT
IFSEC is part of the Protection & Management Series, uniting **security** with **fire**, **safety** and **facilities management** professionals.

REGISTER FOR FREE ENTRY AT
WWW.IFSEC.CO.UK
REGISTRATION CODE
GSMA

IFSEC 2011
16-19 May 2011
NEC Birmingham, UK

SUPPORTED BY

bsia
British Security Industry Association

London First

ADS

ASIS

UK GOVERNMENT

CERTIFIED BY

US COMMERCIAL SERVICE
U.S. Department of State

OFFICIAL MEDIA PARTNER

info4 security

ORGANISED BY

UBM Live

at the outset. Security measures start already at the fence with classic mechanical access components such as gates, doors, barriers, turnstiles, barriers or bollards. These significantly increase the resistance time value. External enclosure of an area either with a fence or a wall provides:

- protection against intentional or unintentional trespass over the compound boundary,
- protection against rapid, intentional and forceful entrance over the compound boundary,
- a reinforced location for the property owner, security personnel or users against intrusion or punishable actions by persons who have gained illegal entry and
- a documented and thereby legally valid compound boundary.

Boundaries should be made straight and clearly visible wherever possible. The ground should be level and without plant growth on both sides of the fence. The entire boundary should also be walkable inside and outside, with unhindered sight and be well lit. It is obvious that fencing alone cannot provide sustainable protection against unlawful entry. Effective outdoor security takes into account landscaping, plant growth, lighting as well as the allocation and usage of buildings and systems.

Depending upon the security requirements, additional access control, vehicle barriers or similar may be necessary. There are many good fencing systems on the market with different heights and material strengths to meet very different security requirements, such as those made of double wire panels, flat bar panels, extruded metal, steel or wire mesh, metal grid panels or polycarbonate. As a rule, fences for industrial or commercial purposes should have a minimum height of 2.2m and possibly also be equipped with Y-form deflectors and rolled barbed wire as protection against climbing over and crawling under the fence. They must also fit artistically and visually in the neighborhood and be adapted to the general appearance of the whole compound. Local regulations and the neighbors must be considered of course. Some of the largest chemical and pharmaceutical factories lie directly adjacent to rivers, and a fence toward the riverbank is often not considered necessary. Instead, it is attempted to close this security hole with movement detectors and video surveillance. However, such open flanks without barriers are gaping holes in the security system. If unauthorized persons encroach, it is often very difficult to get security staff to the scene quickly (that is, before any damage can be done).

Apart from the constructional characteristics of buildings, mechanical protection also includes the doors, windows and other ways in. Here the most important factors are the actual resistance time value and the physical characteristics required for other reasons, such as thermal insulation, resistance to thrown objects, resistance to fire and/or sun protection. The market has everything on offer to satisfy the highest individual

demands, such as security foils like Profilon from Haferkamp to protect against eavesdropping in the management suite, or ballistic-reducing glass, frames and false wall systems from Sitec for computer centers or laboratories.

Electronics and Intervention

In particular in the chemical and pharmaceutical industries, technical security systems must be integrated in a (company-internal) security center – comparable to an expanded emergency and service center – for reasons of economics and simplicity of handling. All security-relevant information that is relevant for danger alerts and the resultant reaction arrives at this point. All these systems are linked and monitored:

- time management and access control systems,
- perimeter detection systems,
- mechatronic locking components,
- video surveillance systems,
- environmental building systems,
- communication technology,
- documentation technology,
- intrusion, attack and fire alarm systems,
- condition monitoring and fault reporting systems.

Such integrated systems are offered by leading manufacturers and have already proven themselves in practice. Quick diagnosis is possible through the combination of standardized automation and security technology – also over great distances – with short reaction and intervention times in 24-hour operation. Of course, this gives emergency, service and response staff a demanding role.

Security Personnel and Training

In large firms and industrial parks the security service is carried out by their own employees or by high-quality external service providers. The required security targets are met with a corresponding concept and implemented with integrated technology. However, it is also obvious for all other, smaller sites that only qualified staff are applied (with a qualification for protection and security). The job of the employees in the company security team includes in particular:

- operation of an emergency call and service center
- assignment of intervention forces
- patrolling and status checks
- vehicle and personnel checks
- surveillance of spaces and buildings
- access control, visitor hospitality
- reception and VIP service
- protection of people and events
- assistance with meetings and large events
- investigation and clarification of crimes
- preventative defense against eavesdropping
- key and access control
- ID card administration.

Philosophy and Public Relations

Corporate security in large companies includes the planning and control of the security of the

company, that is, classic security team tasks. This management responsibility also includes the protection of industrial systems against attack and manipulation by unauthorized people. Also in the list of strategic aims of a security team are, amongst others:

- security planning for different scenarios,
- the creation of security concepts and aims,
- assignment of responsibility, staff assignment and checks.

Security does not belong to the core competency of a company in the chemical or pharmaceutical industry. All the measures to be carried out should be accompanied by a consistent security philosophy that makes it clear to all employees that the reputation of the company, its commercial growth and job security can only be ensured by stable solutions. This is in the first instance a motivational and communications problem and is a task for internal public relations. The internal PR thereby communicates security information to all employees as part of its corporate communication. All of them must absorb the security philosophy and apply it convincingly themselves.

Prognosis and Route

Long-term security prognoses are similar to looking to the stars for answers. Current and short-term developments and estimates for the security of the chemicals and pharmaceuticals industries however assume the following security situation:

- we live in a safe region (!),
- the police are successful in law enforcement and crime prevention,
- total criminality is reducing slightly and crime solving slightly improving,
- product piracy and industrial espionage is increasing (big grey area),
- the industry has already done a lot to protect its people and equipment,
- the danger of terrorist acts has significantly increased,
- the so-called hard targets – (like embassies, consulates, industrial installations and infrastructure for example) and soft targets (like large events and gatherings) are and remain a weak point in our civilization,
- measured and graded security solutions must be met in good time and with a look to the current situation for important targets as well as for key and core industries.

Therefore, up-to-date company security requires a quick and professional response to changes in internal and external security (flexible response). Also in the future, a regular security analysis and the continuous updating of the security concepts by company-external security experts and/or the police is the right way to attain optimum security and thereby to protect the commercial success of the company. It is important not to forget the parachute while the industry is flying high!

Brickcom

Expert in Wireless IP Surveillance

N Serie Superior Night Vision



FB-130N Series / FB-300N Series Coming Soon OB-130N Series

- > Sony Exmor CMOS sensor and ISP
- > 3MP, Full HD, HD resolution
- > Superior Night Vision
- > Unique Profile setting for variable environment
- > MPEG-4, MJPEG and H.264 Triple Codec Compression
- > Local Storage Support (SD or micro SD)

- > POE Support (802.3af compliant or high Power)
- > Removable IR-Cut Filter for Day and Night Function
- > 802.11 a/b/g/n Compliance Wireless Connectivity (Option)
- > WPS Function for Easy Wireless Network Setup (Option)
- > Build-in 3G SIM Slot (GOB-130N only)
- > Smart Focus Support (OB-130N series)

secutech APRIL 20-22, 2011 **Booth J125~136**

A member of  

AIRPORT SECURITY

Hands Up!

A Close Look At People Screening Products – Part 2

Part two of our article on body scanners looks at them through the eyes of those who are being scanned. These devices have been given various nicknames in different languages, not all of them complimentary. But despite loud objections from religious as well as human rights groups and even constitutional lawyers to the presentation of the human body on a screen, almost all passengers when asked are, in fact, in favor of the machines.

Hardened business travelers are quite accustomed to waiting in line to be 'frisked' before entering the air side of airports. These frequent flyers tolerate the long lines at peak hours with pragmatism and patience and are the best prepared passengers before going through the metal detecting archway, having previously removed all metal objects from their person and placed them in the bin that runs through the hand baggage x-ray scanner. The hand-held metal scanner and pat-down frisking process for them is then very quick.

You Can Keep Your Hat On

In x-ray and mm-wave scanning systems, the person is simply required to raise their arms above their head to enable the scanner to 'see'

the whole body. It is therefore easy to understand why certain religious and human rights groups immediately objected to the introduction of such machines that present what they assume to be a detailed picture of the person to a complete stranger.

Manufacturers have already quite easily overcome this objection in two ways: firstly they have effectively dumbed down the original high-resolution 'virtual striptease' of the body form, and facial features can no longer be recognized. This does not reduce the machine's sensitivity to suspect items at all, but simply removes detail from the body image, although surgical alterations or attachments and piercings will still be visible. Areas of the body marked by the analyst for traditional hands-on frisking are displayed to security staff on a neutral diagram.

Secondly, object recognition software is being trialed – similar to that already successfully used in CCTV systems – that obviates the need for anyone to look at the original scan results. Algorithms will identify suspect items and automatically indicate areas of the body which should be more thoroughly inspected. Although early systems were capable of storing images – and some still are for training and evaluation purposes – operators assure us that the newest machines do not have any storage capacity that allows image output and they can therefore not be misused.

Hot Or Not

It is easy to understand the average person's objections to being subjected to any sort of in-

visible rays. Science fiction series and even the humble microwave oven have demonstrated over the years that such rays are deadly. But the intensity is the deciding factor and, while it is hard for manufacturers to quickly prove that there is no known danger in being scanned by either type of machine, help is at hand from the American National Standards Institute (ANSI) with ANSI 43.17 which addresses x-ray scanners for security purposes and with which all such personnel scanners comply.

A lot of misinformation is circulating around the Internet and manufacturers are constantly having to defend their technology. In December 2010, for example, Steven Smith, President of Tek84, found it necessary to write to Rush Holt of the US house of Representatives to counter what he considers to be incorrect third-party information. The debate centers around comparisons between medical and security x-ray scanning, specifically about how deeply the x-rays penetrate into the body as well as the radiation dose on the upper skin layers. His reasoning is that the entire x-ray dose in fact penetrates deep into the body, distributing the effect over a much larger volume. The scanner image, however, is created from the backscatter arising from the first few millimeters of the body, predominantly the skin tissue. The radiation exposure is therefore not concentrated on any given area of skin.

Manufacturers also try to make easily understandable comparisons for the less technically-minded passenger. For example, The Rapiscan Secure 1000, currently the most widely used device, scans with a dose of less than 10 µREM.

Sitting in front of a CRT television for one hour would subject you to around ten times the exposure. During an average two-hour flight above the natural filtering effect of the lower atmosphere you would receive around 100 times the naturally occurring x-rays than being scanned just once. One security scan delivers less than 0.2 % the dose of a medical chest x-ray. Fear of the unknown can be countered with facts like these.

It has been noted during trials, by the way, that the emotive word „radiation“ should not be used on any nearby signs or explanatory leaflets due its negative connotations with Chernobyl and atomic warheads, whereas the word „x-ray“ is perfectly acceptable thanks to its positive medical benefit even though the radiation dose is many thousands of times higher than a single body scan.

Spreading the Word

The American Transportation Security Administration (TSA) is taking a firm stance on enforcing passenger scanning. By the end of 2010, around 500 systems will be in mandatory daily use at US airports. As increasing numbers of passengers are going through body scanners and finding the experience quite acceptable, word-of-mouth is ensuring that initial resistance to these systems is fading fast. In fact, four out of five

passengers prefer to be scanned by a machine than have a total stranger pat them down – still a slightly humiliating experience, even for frequent flyers.

Although there are still pressure groups who coordinate their efforts to have the ‚porno scanners‘ banned, reassuring words from manufacturers, government agencies and the media as well as demonstrations of the ‚fuzzy‘ body images that are actually produced are all helping to improve the acceptance of these systems. A continued program of education will help to overcome the often ill-informed and exaggerated opinions held by opponents of such scanners. With further development, shorter scan times will be possible and that will mean shorter lines after check-in before going air-side. That is something the airport operators, security staff and passengers alike will come to greatly appreciate.

Part 1 of this article was published in GIT SECURITY 1/2011. You will find Part 1 of the article also on www.GIT-SECURITY.com

► www.git-security.com/topstories/security/airport-security-hands

► CONTACT

Whole Body Imaging Manufacturers:

AS&E
„Smartcheck“
Tel.: +1 978 262 8700 · www.as-e.com

Brijot Imaging Systems Inc.
„GEN2“
Tel.: +1 407 641 4370
www.brijot.com · info@brijot.com

L3 Security & Detection Systems.
„Provision“
Tel.: +1 781 939 3800 · www.sds.l-3.com.com

Qinetiq
„Borderwatch“ and „SPO-20“
Tel.: +44 8700 100942 · www.qinetiq.com

Rapiscan
„Secure 1000“ and „Wavescan 200“
Tel.: +44 870 7774301
www.rapiscansystems.com

Smiths Heimann GmbH
„eqo“ and „B-Scan“
Tel.: +49 611 94120
www.smithsdetection.com
germany.info@smithsdetection.com

Tek84
„Ait84“
Amit Verma (Director of Government Affairs)
Tel.: +1 858 676 5382 Ext. 103
www.tek84.com · amit.verma@tek84.com

Ultimate precision with
Dual Ray Technology

125  **Bosch**
Years 1886–2011

Automatic Fire Detector 420 Series

Intelligent detection. Superior protection.

Protection for every requirement. Bosch has extended its range of detectors equipped with Intelligent Signal Processing (ISP) technology, adding three new variants with Dual Ray Technology. The 420 Series now detects fires faster and more accurately than ever, while minimizing false alarms in every environment. The series covers every Test Fire (TF) category of which the FAP-DO 420 variant is a cost-effective solution to detect Test fire TF1, even without the combination of other sensors. www.boschsecurity.com



BOSCH
Invented for life

PERIMETER PROTECTION

The Improved Garden Fence

A Video Surveillance Upgrade Reduces Losses

The owner management of Mr. Smith, a company that manufactures and sells gardening tools, is in the fourth generation. Young visitors of the discotheque in the neighboring industrial area have been climbing over the wire mesh fence at night and products exhibited outside are often damaged or even completely destroyed. Inside, there are irregularities at the checkouts too. This is why Mr. Smith Junior decided to improve and extend the video surveillance system.

Although Mr. Smith Senior had already taken preventive measures during his time as Managing Director, when his business contents insurance company canceled the contract because of too many claims, Mr. Smith Junior made the decision that something must change. The friendly lady from another insurance company told him that his insurance costs would be much lower – in comparison to his old insurance – if he installs a suitable video surveillance system. According to statistics, this measure would reduce the number of burglaries and hence also lower the insurance risk. He would therefore kill several birds with one stone.

The company also successfully exports its goods to European countries. His customs specialist informed him that there are new requirements to be met by export companies, if they want to retain their status as an Authorized Economic Operator (AEO) in the future. One of the criteria for receiving the AEO certificate is the recording of material flow of incoming goods, to warehousing, to production and through to distribution. Here an intelligent video surveillance system is an optimum solution because there is then no need to hire more staff for the tracking of the products.

Here Today, Gone Tomorrow

Father's preventive measures had included the installation of three analog cameras outdoors and one camera behind the cashier, the data being recorded for years on a digital recorder, but the investment had not yet paid off because the existing cameras were not sufficient for complete control. Two branches of the company are located in the north and the south of the home state respectively where circumstances are about the same. One branch was equipped with



just one camera. The other branch was equipped quite well with eleven cameras but even those images were not very valuable.

The management had noticed quite often that many more of the smaller containers of engine oil had been sold than were actually in stock. On the other hand, the more expensive packages were regularly missing from the retail shelves, although according to cash entries they should not yet have been sold. Other local businessmen told similar stories: cashiers set the price of a cheaper product manually, take the full price of the purchased product from the customer and were lining their own pockets with the difference. The management had no proof

of this because the videos did not show what prices were set by the cashiers while selling a product.

Enhancements

To get a second opinion and to have a better basis for decision-making, Mr. Smith Junior instructed an Axon certified partner from the area to have a first-hand look at the difficulties. He noted that the existing cameras were good and also the positioning was quite good too. However, the wrong lenses had been chosen as they were too wide-angle. A huge area could be recorded but, in the case of an alarm, there was no usable material because the records were not

detailed enough. The Axxon partner also had a solution for the problem with the cash desk accounting.

The outdoor area complement was enlarged from three to eight cameras. This made it possible to use camera lenses with smaller angles, and the resultant image quality left no doubt about the recorded events. Some new and clearly visible signs were fixed on the fence to make potential thieves aware of the video surveillance. This measure not only met legal regulations but also has a continuous dissuasive effect.

The warehouse and the production area also now have video surveillance so that all finished and unfinished products are under constant observation. The products are registered into the system with an external integrated bar-code recognition software and the data stored. This enables management to always have a current inventory available.

In Sync

Because there are three branches of the company, the Axxon partner advised Mr. Smith Junior to use the larger software variant of Axxonsoft called Intellect 4.8. This software can be enlarged to an unlimited amount of cameras, and all types can be integrated and easily managed within the system. One server was placed in each branch that communicates with each of the oth-

ers. The client was installed in the head office, enabling management to access all the cameras installed in all the branches. To prevent frequent false alarms, the software is programmed so that an alarm is only given if an object comes over the fence from outside, enabling customers to move freely within the sales areas to look at the products. All movements at night trigger an alarm of course.

The Axxon partner advised Mr. Smith to expand the software with the "pos" module for the checkouts. Every price entered into the keyboard of the cash register is synchronized with the video recording. Thereafter, management can have a look at any event when, for example, the price of a smaller package has been entered and then have a look at the corresponding picture. It is then possible to establish if the smaller package has changed hands or whether one of the more expensive packages has gone over the counter.

Order Restored

The operation of the Axxon Intellect 4.8 is very simple, even for those not so familiar with computers, thanks to an intuitive interface. All essential elements are directly reachable and a single mouse click gives access to the individual records. A list of incidents shows what happened most recently. The selection of cameras from

the position plan simplifies handling greatly. If needed, the system can even inform via e-mail or SMS, and live images can be viewed on suitable mobile devices.

After informing the cashiers about the new checkout software, there has not been any difference between the nominal and actual inventory. Also the boundary fence is still intact after half a year. There is a small dent where someone has tried to climb over – as can be clearly seen on the video for this moment – but the intruder was deterred when the light was turned on as an automatic reaction of the software to such an event. Whether Mr. Smith receives the AEO certificate depends on the result of the official authorization process. But, in any event, certification will not fail because of the incorrect registration of material flow within the company.

► CONTACT

AxxonSoft GmbH, Wiesbaden, Germany
Tel.: +49 611 1575140 · Fax: +49 611 1575141
johanna.flohr@axxonsoft.com · www.axxonsoft.com



DIGITAL ABSOLUTE PLUS

DIGITAL

Dual TECHNOLOGY Barrier

range 200 mt.

IMN200RS series

State of the art combination of Microwave and IR technologies to assure maximum protection while drastically reducing false alarm rates due to uncontrollable agents.

- Detection Mode: MW + IR
- Range: 200 mt.
- Heights: 2.0 - 2.5 - 3.0 - 4.0 mt.
- Nr. of IR beams: from 2 to 8
- Nr. of microwaves: 1 / 2
- Alarm signal: Contact Relay and/or RS-485
- RS-485 output for remote programming and diagnostic







ALARMITALIA®

outdoor protection
our profession

SICURIT Headquarter
Via Gadames, 91 Milan - Italy
T : +39.02.380.70.1
F : +39.02.308.80.67
I : www.sicurit.com
E : export@sicurit.it



MADE IN ITALY



© Dash - Fotolia

PERIMETER PROTECTION

Intuitive Control

Rolling Multiple Management Systems into One Human Interface

As different security systems are added and grow over time, a confusing mix of separate control systems each with their own proprietary method of displaying information to the operator can be the result. When quick reactions are called for, or simply to avoid incorrect operation of these essential systems, it is essential that information is displayed and objects represented in a uniform and easily understandable form. This is one of the motives for Scurit to develop an icon-based user interface.

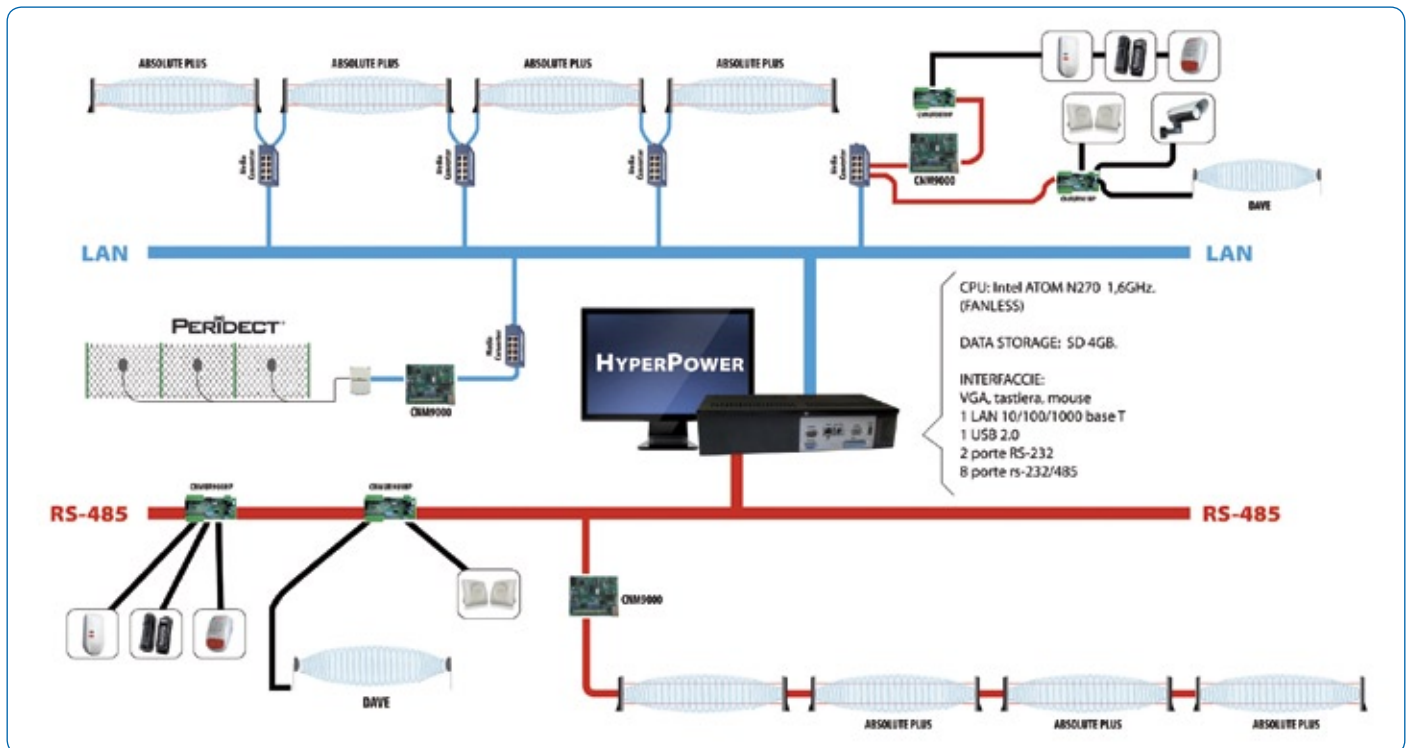

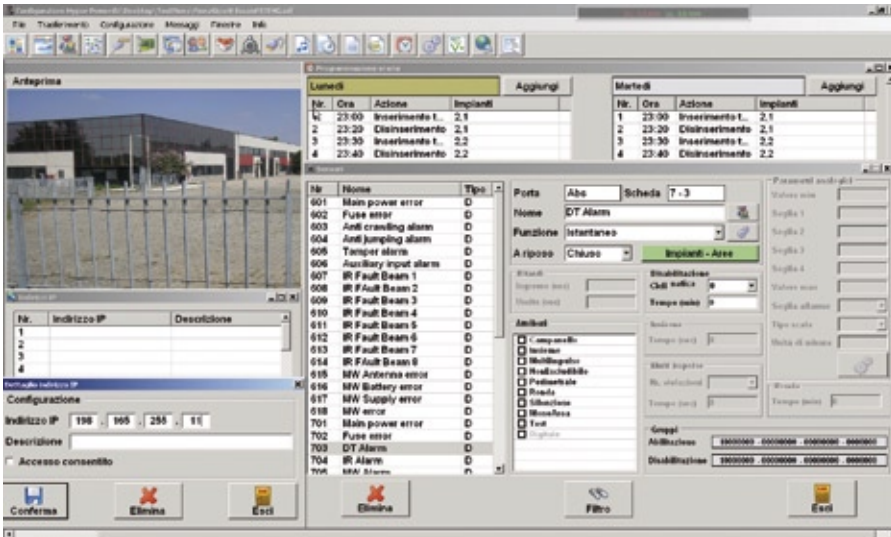

The display of the system is created in graphic mode using site maps that immediately make the status of the system apparent.

Sicurit's new security monitoring and control system handles incoming alarms and presents these in the most 'human' way possible. The Hyperpower Industrial Multi-system Management Control Unit (HPCU) is a modular and programmable multi-system control unit suitable for any industrial integrated application. Being programmable, it is highly flexible in its application and is ideal for the supervision of complex perimeter security systems. It has been developed for the supervision and control of different systems within one unique management interface, and is equipped with high security peripherals which make use of a proprietary multi-point bus.

The HPCU already allows the full integration and management of Sicurit's own dual technology barriers from the Absolute Plus range as well as the Peridect pin-point fence perimeter detection system. But not only the company's own products are considered: also other alarm signals and input from third party manufacturers can be connected too. The number of remote interfaces can be configured as required by adding the appropriate expansion boards. In total, the system can accept over 3,000 different inputs via RS-485 together with a host of TCP/IP inputs or outputs over the Gigabit Ethernet port, only limited by the number of available IP addresses.

Status in Color

The display of the system is created in graphic mode using site maps that immediately make the status of the systems apparent. Icons are placed accordingly that assume different colors and shapes depending on the status of the object that they represent (inputs, outputs, locations etc.). Through the icons, the operator can send commands to the system (control areas or exits, position cameras, request video images etc.) taking all the actions necessary to manage the entire system. They can easily arm or disarm

selected areas, grant levels of access and set timed access to specific zones as well as configure user groups.

As well as recording the alarm events coming from the field, all actions by any of the registered operators on the supervision terminal (computer) are logged, allowing a subsequent analysis of everything that has happened on the system (alarms, operator reactions to alarms, images from the alarmed area etc.). The HPCU also informs the operator about any possible failure or anomaly of the Absolute Plus dual technology barriers. All this work is handled in the central control unit by a fanless industrial PC in a 2U 19" rack enclosure that coordinates all the various interfaces. A power supply of either 12 VDC or 230 VAC ensures continuous 24/7 operation.

Leading^A
the way in
Megapixel
video

Cutting-Edge
Innovations

Superior
Performance

Broadest
Selection of
Megapixel
Cameras



Arecont Vision
megapixel technology...
beyond imagination

+44 (14) 4085 8054
ArecontVision.com

made in the USA

► CONTACT

Sebastiano Vento
Sicurit Alarmitalia Spa, Milano
Tel.: +39 0238070317 · Fax: +39 023088067
sebastiano.vento@sicurit.it · www.sicurit.it

SECURITY FOR PUBLIC SECTOR

Going Keyless on Campus at Westminster

Increased Security and Ease of Accessibility in a Central London College

The City of Westminster College in the heart of London is well into an ambitious program of redevelopment and refurbishment that, since January 2011, has been able to start supporting their education and training programs with state-of-the-art facilities.

The main element of the program is the comprehensive redevelopment of the College's former Paddington Green site to provide a state-of-the-art new main campus. It opened in January 2011, and now offers an outstanding teaching and learning environment within an exceptional seven-storey building that is a flagship for Further Education in London and the region. At £102 million, the ambitious scheme is the highest value single site redevelopment agreed by the Learning and Skills Council (now replaced by the Young People's Learning Agency and the Skills Funding Agency) and their 86 % grant is one of the largest financial contributions to the project.

The new campus has been designed by award-winning international architect's Schmidt Hammer Lassen, who have been responsible for a number of outstanding, innovative public and private buildings in Norway, Sweden, Greenland and China, as well as in their homeland in Denmark. Set in the center of North Westminster, the new campus features a large atrium at the heart

of the building, with accessible roof terraces. It provides state-of-the-art facilities including specialist science labs, a large sports hall and a wide range of workshops, as well as offering community access to new facilities such as a 150-seat theater and a public café overlooking St Mary's Gardens.

The College offers around 250 full and part-time courses to over 7,000 students each year so to make the new building a success much though had to be given to the design and implementation of a robust security plan that would allow for free flow of traffic throughout the building while safely and securely controlling who could access what, where and when.

To do this the College approached GES Security Services with a remit to provide a cutting edge solution for the security within the College. This proved to be quite a challenge for the company's design and estimating team, as Sales Manager Stephen Hastings explains.

Future Strategy

"There is no doubt that the design of the new building on the Paddington Green site is fantastic. The use of glass is extensive and the fresh modern look and wide open spaces will create a wonderful learning environment for the students. But for us the challenge was how to effectively provide a multi-faceted security solution that



would not only complement the aesthetics of the building, but also meet and exceed the high level objectives expected by the College.

After a considerable period researching the available applications and products that we thought may be suitable for City of Westminster College, and working closely with the in-house facilities manager who would run the eventual system, we were able to present a security strategy that was both technologically advanced and highly cost effective. Its key aims were to utilize the impressive IT infrastructure of the building for the CCTV element, as distributed IP systems are becoming more popular with new build projects due to their minimal cabling costs compared with traditional analog systems, incorporate a traditional intruder alarm system and provide an almost keyless building with regards to the access control solution. This would not only deliver convenience of use and security for students and staff alike, but also reduce costs and increase efficiency whilst simultaneously providing a future-proof system that could grow to meet any future requirements of the college."

Cameras and Alarms

For its CCTV solution, the College wanted a flexible, scalable package that could keep pace with its growing operations while maintaining the highest level of security. The system specified by GES Security Services was a network solution using control center software. This provided the scalability and ease of use that was needed as well as image compression and transmission technology.

The 85 cameras on the system feed recordings directly into NVRs and through the use of their activity controlled frame rate will maximize the storage capacity and minimize the bandwidth usage. The move to IP has saved space and reduced infrastructure and maintenance costs as the internal network cameras will use the Power over Ethernet (PoE) capability of the IT Infrastructure. In contrast to this, the intruder alarm system will be installed using its own cable infrastructure, which will provide a stable platform suitable for the building.

Access Control Overview

To achieve the aim of creating an almost totally keyless environment for the Paddington Green site, the access control system selected was the Salto Virtual Network system (SVN). Stephen Hastings says "We chose this system over all others because of its unique ability to distribute card holder and system information to access controlled doors that are not cabled to any controller, which is made possible by using the card to upload and download information between on-line and off-line doors. Of the 264 access controlled doors in the new building only 21 are on-line, negating the need for power and containment at each door. This makes for a system that is not only effective but also considerably reduces the cost of ownership per door when compared with standard on-line systems."

Management of students, staff and visitors is crucial for the College and this would be the key application for the new access control system. The College's vision is to have a true multi-application smart card environment totally removing the need for traditional keys, where as required cards can be enabled for photo ID, cashless vending, canteen, library, on demand printing, use of lockers and more. To accomplish this, a highly secure and flexible access control system has been designed using off-line XS4 E9450 handle sets and locks and a mix of on-line WRM9000 wall reader units utilizing the power of the Salto Virtual Network (SVN).

This system allows the XS4 units to read, receive and write information via the College's student and staff ID cards. Since most access related information is kept encrypted on these cards, the wall readers are able to update and receive information from the cards at any time. So not only is the system easy to use, but its clever functionality also provides 90% of the benefits of a fully on line access control system at the cost of a stand alone system.

The 'smart' ID cards build up 'on-card' audit trails through normal use giving the College complete control over access and enabling the movement of students, staff and visitors to be tracked through both the off-line and on-line parts of the system if required. This enables a complete access profile of each individual to be established and updated as necessary at the up date wall readers. It can also program keys to allow access to specific rooms or areas within the College for selected periods only, with the doors auto locking at pre-specified times as required. And if key security is breached due to the loss of a key card, it can be instantly deleted from the system without the need or cost of re-keying or changing locks – saving the College time and money.

High-satisfaction Technology

The City of Westminster College is a very forward thinking environment and, with the incorporation of the latest CCTV, alarm and access control technology into their new campus facilities, they have taken the necessary steps to ensure they will be able to achieve far reaching and long lasting control over their security requirements.

Key operational benefits met by the technology include a more flexible and reliable system for a lower total cost of ownership, the benefits of an almost totally keyless environment and thanks to its Salto SVN system, the ability to manage up to 64,000 users and doors in a single system if required, making the college a secure and accessible environment for all its users.

► CONTACT

Carlos Elosegui
Salto Systems Ltd., Oiartzun, Spain
Tel.: +34 943 344741
c.elosegui@saltosystems.com
www.saltosystems.com

The World's First Open
HD Surveillance Platform

www.avigilon.com



AVIGILON
THE BEST EVIDENCE™



“Superior image clarity combined with the system's advanced management features for fast and easy video recording and playback make Avigilon today's ultimate choice in HD surveillance.”

Airberg

SECURITY FOR PUBLIC SECTOR

Passed the Test

Walsall Academy Upgrades to a Powerful Hybrid Surveillance System

Built in 2003, Walsall Academy in Bloxwich, West Midlands is a state-of-the-art educational facility that offers 1,150 secondary students the opportunity to specialize in science, technology and performing arts along with a wide range of academic and work-related courses. The Academy recently upgraded to the Avigilon HD Surveillance System to better protect its high value areas and safeguard staff and students.

Walsall Academy instills a positive culture focused on providing a calm and purposeful yet challenging learning environment where high standards and traditional values of good behavior, honesty, and mutual respect are the hallmarks. The Office for Standards in Education, Children's Services and Skills (OFSTED) was established in 2007 to ensure the highest standards in care and education for children, young people, and students of all ages across the United Kingdom. In recent years, student safety has become a top priority for OFSTED inspectors, who carry out hundreds of reports and regulatory visits each week.

Walsall Academy's overall effectiveness has been graded outstanding, not only for excellence in academic achievement, but also because of its students' exemplary behavior, due in large part to the Academy's ability to manage student behavior firmly but fairly. "Having a reliable, high quality surveillance system to monitor hot spots across the campus has played a significant role in our ability to not only protect our high value areas – such as our technology and music suites – but also to ensure our students' safety, well-being, and good conduct," explained Adrian Bowater, Director of Finance at The Walsall Academy. "We are proud to have achieved such high standards in student behavior."

Surveillance Grows as Needs Evolve

A 189,000 square foot two-storey facility, Walsall Academy installed a basic analog-based surveillance system when it was first built but found that the image quality and management features could not always meet their needs. "As

we identify new areas that require coverage, our needs have naturally evolved and will no doubt continue to do so over time," explained Bowater. Limited by a fairly tight budget, the Academy was not in a position to replace its existing analog system entirely, but wanted to improve its system performance and investigative success.

To achieve his performance goals, Bowater chose to upgrade the Academy's software for better results and turned to the experts at Technical Services (Shropshire) Ltd., a local provider of surveillance system design, installation, and service, who recommended Avigilon. "To make better use of our existing cameras, we chose to upgrade to a video management software (NVMS) platform to enhance system management and dramatically improve image quality, leading to more effective investigations and greater conflict resolution."

Administrators now seamlessly manage the Academy's hybrid surveillance system using Avigilon Control Center Enterprise NVMS with HD Stream Management and installed Avigilon HD cameras to monitor main entrances and parking lots for reliable license plate recognition, and to cover corridors, cloak rooms, and technology suites for greater image detail and facial recognition. Walsall Academy also installed analog video encoders from the same manufacturer to boost the performance of its existing analog-based cameras which are located throughout the interior of the school. The manufacturer's network video recorder (NVR) was added to store up to 18 days of continuous surveillance video - a big improvement over its previous system, which could only store seven days of footage. "We now have fuller coverage of the facility so we can track who is on site to ensure the utmost security at any time of the day or night," said Bowater. The surveillance system operates 24x7 and is monitored live by administrators during the day and remotely by key staff if necessary.

Early Success Improves Behavior

"The surveillance system is critical to our ability to track students' behavior and reduce horse-play and petty theft," explained Bowater. With the Academy's previous system, particularly in high traffic areas, Bowater would not always be able to identify a student involved in a misdeed. "Now, when we add new cameras, we find that the problems move to other areas that aren't

**OUR
ANNIVERSARY
ISSUE
2011**

Issue 6/2011 – June +++ Editorial till
2.5.11 +++ Adverts till 30.5.11 +++
Release on 16.6.11 +++

GIT SICHERHEIT
MAGAZIN FÜR SAFETY UND SECURITY



2011
20 years
GIT SICHERHEIT

GIT VERLAG
A Wiley Company



currently being monitored – a mark of the system's success in helping to reduce student misbehavior in key areas." As budget permits, the Academy will expand the system to cover all hot spots.

According to Bowater, "Avigilon Control Center Enterprise offers great flexibility to dramatically improve our ability to research difficult situations, significantly boosting our overall investigative success." Without a full-time security staff, school administrators manage the surveillance system, so ease-of-use was another top priority. "This software is not only highly effective, it is also very user friendly," said Bowater. "The school's previous analog-based surveillance system was simply not as intuitive, requiring a certain level of expertise to manage it." With support and training from local partner BFI Optilas Ltd., school administrators were quickly up and running on the Avigilon HD Surveillance System - and achieving remarkable results. "Previously, we only had two technical staff members who could work the old analog-based system but with this one we were quickly able to expand the team to share the load," he added.

Closing Cases

With advanced features to improve performance and manageability, Avigilon Control Cent-

er not only saves the Academy time, it also dramatically improves investigative success. "Using the product's advanced search capabilities, we can find specific footage in a third of the time, significantly expediting investigations," added Bowater. The school can also quickly and easily export video and photos to give to local police officers who have occasionally relied on the Academy's surveillance system in their own investigations.

Like most educational institutions around the world, Walsall Academy must find innovative solutions to advance the educational experience while working within fairly tight budgets. With this in mind, the Academy chose this solution because it leverages the school's fixed assets while significantly improving overall system performance. "Because our analog cameras are not that old we did not feel the need to replace them entirely, but at the same time we didn't want to run two separate systems," said Bowater. By installing analog video encoders, Walsall Academy can actually achieve better results with its analog cameras without the expense of having to remove them and install cabling for all new cameras. "We were able to expand our coverage and improve image quality for the same cost of adding more analog cameras by deploying the Avigilon system."

Ripple Effect

The original challenge was to protect high value areas across campus and safeguard students to ensure their safety and good behavior. A key tool in the Academy's plan to maintain excellent student behavior, the surveillance system has helped Walsall Academy create a safe and enjoyable environment for students and staff. "With this system now in place, our students know that we can achieve better quality footage if incidents do occur, which has caused a ripple effect across the student body to improve overall conduct," concluded Bowater. "You can almost feel the difference."

CONTACT

Heather Drugge

Avigilon, Vancouver, Canada

Tel.: +1 604 868 1309

heather.drugge@avigilon.com · www.avigilon.com

VISUAL DISPLAY SOLUTIONS FOR COMMAND & CONTROL - MADE IN GERMANY

Professional Narrow Bezel LCD Screens for Video Walls

) EYE-LCD4600-SN – The Original Proven Design

46" Diagonal / 1366 x 768 Pixel / Active-to-Active: 7.3 mm

) EYE-LCD5500-USN-LHD – New Version with LED Backlight

55" Diagonal / 1920 x 1080 Pixel / Active-to-Active: 5.7 mm

) EYE-LCD6000-SN – New Version with LED Backlight

60" Diagonal / 1366 x 768 Pixel / Active-to-Active: 6.5 mm

... and many more products for sophisticated control room applications: DLP® cubes, graphic controllers, wall management software and accessories.

) **eyevis GmbH**, Hundsschleestr. 23, 72766 Reutlingen/Germany

Tel.: +49 (0) 7121 43303-0, Fax: +49 (0) 7121 43303-22, www.eyevis.com, info@eyevis.de



IFSEC2011 Hall 4
16. - 19. May 2010
Stand D145

eyevis
PERFECT VISUAL SOLUTIONS



COVER STORY

Watching Coastlines Via the Cloud

Coastalwatch Safeguards Shorelines and Popular Beaches with Hosted Milestone Video

When you picture some of the world's most beautiful beaches, you're no doubt envisioning long, curving expanses of white sand, clear blue waters and the soundscape of rolling waves and warm gentle breezes rustling through the palm trees overhead. What may be missing from your mental scenario are the hidden dangers – powerful currents capable of sweeping an unassuming swimmer or surfer out to sea, or massive waves that can wreak havoc on everything in their path, not to mention dangers caused by the slower erosion of coastlines and other environmental hazards affecting humans and animals.

Born from its founders' love of nature and seeking to provide fellow surfers with real-time wave and water conditions, Coastalwatch is an innovative Australian company that has the world's coastlines under its high-tech eyes with networks of private and publicly owned surveillance cameras. Employing a set of sophisticated analytics they have developed themselves, Coastalwatch services international surf life saving and coastal management needs by delivering live and recorded video and information on beaches around the globe via its CoastalCOMS division. CoastalCOMS monitors several beaches along Australia's Gold Coast, as well as coastal areas in western and southern U.S., Hawaii, and Denmark, too.

Integrated Solutions Using the Milestone SDK

As a main component of the CoastalCOMS monitoring platform, the company is using Milestone XProtect video management software to provide live video surveillance and critical real-time data to marine safety and coastal management officials. CoastalCOMS' analytics software and multi-national network of hosted coastal cameras are also used for the collection of real-time beach and surf-zone data, such as wave height

and wave period analysis, vessel monitoring and counting, people counting on beaches, as well as tracking changes in the shoreline and general beach state.

With access to over a hundred Coastalwatch-owned cameras on the ground in Australia and many more private or municipally owned cameras in the U.S and abroad, CoastalCOMS uses XProtect to centrally view and control cameras globally, layering in the ability to extract data for environmental monitoring, public education, tourism and recreational usage.

"XProtect software allows us to create 'networks' of coastal cameras on the fly, patterning and sourcing video from both new and existing beach cameras according to each customer's needs. We then process the video in real time for different groups based on their reporting needs and workflows," says Tim Chandler, President/CEO of CoastalCOMS. "Integrated into our solution using the Milestone SDK, XProtect makes it possible for us efficiently source video, then provision access to the video and cameras so only the right people can view the video and information at the right times."

With the XProtect API, CoastalCOMS-enabled cameras can automatically re-position

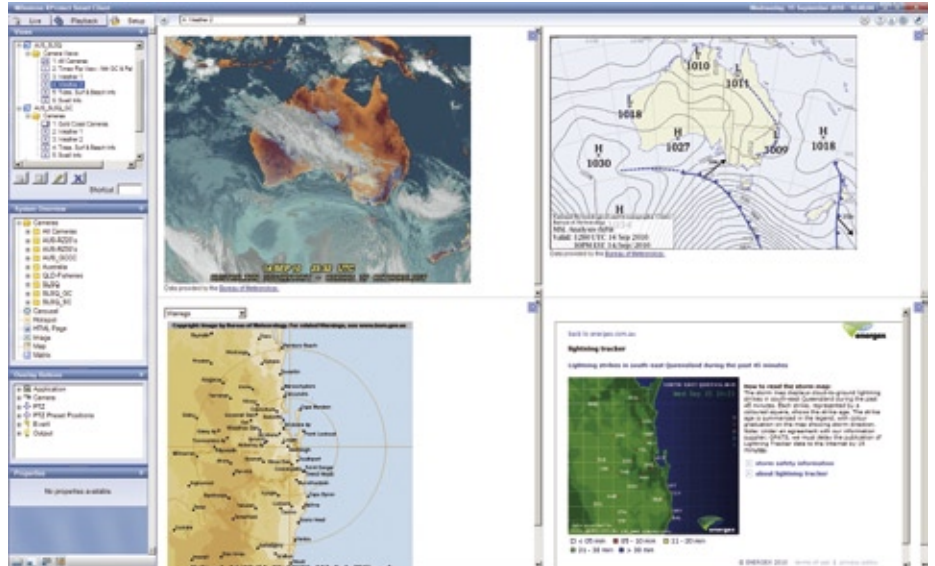

Coastalwatch's analytics and weather system info integrated into Milestone's XProtect Smart Client

themselves based on alerts from external sensors or data feeds, such as a status change in an emergency management system, a Weather Service warning or alert, or a measured change that happens in front of the camera.

"By integrating external sensors and data feeds into our core platform, we don't even have to press a button to drive cameras based on environmental change," Chandler adds. "This provides our customers with unprecedented abilities to gather information and images to better understand conditions and coordinate responses in changing beach environments around the world."

People Counting, Wave Measurements and Shoreline Changes

Different combinations of the imagery and information are used by such customers as the City and County of Honolulu Hawaii's Ocean Safety Division, where CoastalCOMS assists surf lifeguards with hosted surveillance platforms capable of wave height analysis and people counting. The City of Galveston, Texas, also chose CoastalCOMS for surveillance of remote beaches because it increased the ability to measure the amount of shoreline change as a result of hurricanes.

Video streams from a CoastalCOMS camera network being used by Surf Life Saving Queensland are also available to the public on Coastalwatch.com, which provides live video images, wave height and swell information, daily surf reports and other news to the international surfing community. When authorities need to take manual control of the cameras during a lifesaving incident, integration with CoastalCOMS XProtect solution allows the live images and HD video on the media site to be cut off and replaced with other media content so as not to broadcast the command and control activities of lifesavers and marine safety to the public.

Coastalwatch uses mostly Sony cameras in their own network and the networks they in-

stall for clients. Their current solutions include a blend of Sony RZ25s with SNTX101s in place, a huge install base of Sony RZ50s, and a growing number of the newer HD lines including the SNCRH164 HD domes and the bullet style SNCCH180 HD cams. Coastalwatch has been a Sony partner for years in Asia/Pacific/Australia working with Sony engineering out of Japan. "We can attest to how great the Sony optics and imaging are, as well as to the importance of their PTZ cameras' 'return-to-preset' accuracies and overall encoding abilities for what we do," Chandler reports.

Watching Earth Via the Cloud

The company is now scheduling cameras and reading video for processing directly from the Milestone database through an integration with the CoastalCOMS cloud platform.

"We rely 100% on the economies and extensibility of cloud computing, and I believe our experience operating Milestone in the Amazon cloud is a key differentiating factor for us in the surveillance marketplace. Using our hosted platform we've deployed 3G/4G mobile surveillance units with Hawaiian guards, using a Sony SNC RZ50N camera that automatically reports to the cloud when turned on, notifying lifeguards and IT Support when the cameras are deployed on the beach. Notably, this unit also has a VoIP loud hailer for communication of warnings to the beach-going public. The fact that these units are movable means cameras can be deployed when and where they are needed, automatically giving "remote eyes" to lifeguards in areas of concern via our hosted Milestone XProtect platforms," explains Chandler.

Surf Life Saving Denmark last year installed a high definition CoastalCOMS camera at Hvide Sande Beach in West Denmark as a pilot project. The HD camera is in use to support lifesaving efforts by providing decision support at this busy German tourist destination. The video from this system is managed via the CoastalCOMS hosted

Milestone cloud presence in the UK, and can be serviced jointly by both US and Australian offices. Since most of the infrastructure normally deployed on location is instead deployed in the cloud, the only resource they need in Denmark for this solution is a local person for simple break fixes on the field hardware. The added abilities of CoastalCOMS' wave and environmental data processing for the lifesavers will be useful for both public safety and tourism.

Award Winning Solution

In January, Coastalwatch was awarded the 2011 Pioneer Award at the Australian Surfing Hall of Fame Awards for CoastalCOMS WavePak processing technology. The annual award is given to a person, group, or organization that through the application of an idea and/or commitment to a project have broken new ground while contributing to the enhancement and innovation of the sport of surfing in the prior year.

Specifically designed to capture information about the powerful and unpredictable ocean environment, CoastalCOMS analytics dynamically measure individual waves as well as periods of wave movement, examining the shore and waterlines to determine the areas of change and identify hazards.

"Rips form based on the dynamic changes in coastal environments, and rips are a major cause of death by drowning. Monitoring beaches and proactively identifying dangerous conditions helps first responders identify hazards and manage risk on remote, public beaches," concludes Chandler.

► CONTACT

Courtney Dillon Pedersen

Milestone Systems, Brøndby, Denmark
Tel.: +45 88 300 300 · Fax: +45 88 300 301
sales@milestonesys.com · www.milestonesys.com

CoastalCOMS
www.coastalcoms.com



SECURITY FOR PUBLIC SECTOR

Stadium Safety and Security Is Custom-made

How to Meet the Security Challenges of Sports Stadiums and Entertainment Facilities

It is inevitable that safety and security problems will arise when many people come together in a confined space.

This is especially true for sports stadiums, where emotions often run high. The range of incidents that organizers and security personnel have to be prepared for extends from pick-pocketing and aggressive behavior – often under the influence of alcohol – through to fire and bomb threats. In addition, the supporters of two different teams frequently have to be physically separated in stadiums, because violent “fans” not only endanger themselves, but can also trigger mass panic in extreme cases.

Safeguarding work often begins a long time before the event itself. Police officers accompany soccer fans who are known to be violent on the journey to away games. Border controls have even been reinstated for international tournaments within the Schengen area. The goal is to take preventive action in the build-up to the event and to avoid foreseeable security incidents at the venue.

Video Surveillance as a Valuable Tool

While measures such as these prior to the event are always very specific, depend on the current situation and are of a predominantly organizational character, safety and security at stadiums themselves are usually based on the same fundamental principles. Stadium operators generally require comprehensive video surveillance systems allowing them to efficiently monitor all areas and activities. This enables them to immediately detect fires, emergencies and threats. Video systems also help to detect potentially

hostile groups at an early stage to curb the risk of riots and violence. Further, they can include outside cameras to continuously monitor groups approaching, entering or leaving the stadium.

In the event of a fire or other emergency event, it is vital to maximize safety by evacuating the stadium. Therefore escape routes must be established, marked and kept free – another area where video surveillance can come in useful. As a panic is often even more dangerous than the event that triggered it, clear announcements are of utmost importance to support coordinated evacuation and to keep everything under control. Modular public address and voice evacuation systems are therefore required which allow operators to make announcements in certain zones only or everywhere at once. Professional audio equipment such as the Dynacord or Electro-Voice brands from Bosch can often serve other purposes as well – many modern sports stadiums are designed to also host concerts and other cultural events. Such systems are widely used in Olympic and world cup stadiums as well as in large indoor venues.

False Alarms Are Not an Option

Fire breaking out within or near a stadium is a major threat. It is essential to quickly detect, locate and verify a fire in order to contain it and protect people and property. However, false alarms must be avoided at almost any cost. They might trigger an unnecessary and costly evacuation and – in a worst case scenario – even lead to panic. Fire panels and detectors must therefore apply multiple intelligent criteria to ensure

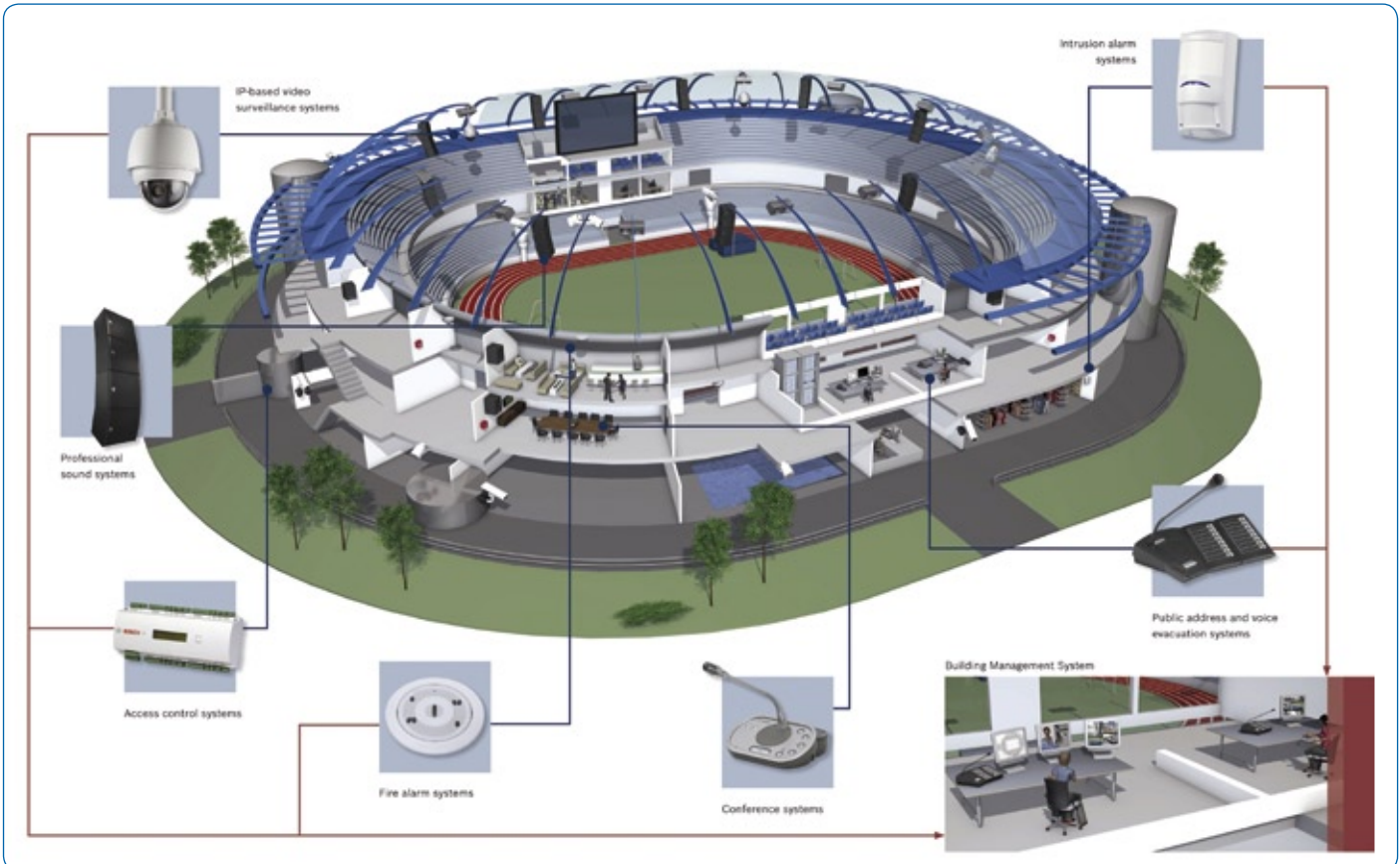

A venue the size of a stadium inevitably has multiple security, safety, communication and building automation systems installed. So there is a considerable need to efficiently manage them all.

fast, reliable detection under a variety of conditions. Modular systems like Bosch's Modular Fire Panel 5000 Series maximizes flexibility, e.g. for future expansion as in the Loftus Versfeld Stadium in Pretoria, the home of the Vodacom Bulls Rugby Team and one of the venues of the 2010 Soccer World Cup. One fire panel had been installed during construction of the stadium itself, while three more panels were added later in a second section of the complex. All panels are networked and operated as a single system, allowing flexible configurations with central management and operations.

While the main purpose of a stadium is to host as many spectators as possible, not all facilities should be accessible to everybody. A large sports stadium is typically divided into public and non-public areas, each with specific security requirements. The public areas include the arena seating, parking garage, access roads, entrances and corridors, restaurants, and food and beverage corners. Non-public areas include the changing rooms, offices, press center and other facilities such as treatment rooms and business lounges. Furthermore stadiums often house additional businesses like offices and shops. Most of these non-public areas require intrusion detection and access control systems to make sure that only authorized individuals are able to get in. These systems again can work hand in hand with video surveillance which enables early detection of suspicious behavior such as loitering or walking in off-limits areas. A "forensic search"

function enables fast retrieval of relevant video sequences.

Integration

While the planner's focus was previously on the pure functionality of the individual safety and security systems, integration of these individual systems is now viewed as a matter of great importance. For example, fire protection and evacuation are now so closely linked that the advantages of integration with a common, centralized control center are evident. But the inclusion of video surveillance, for example, in this control center can also increase safety and security considerably. Potential fire hazards and blocked emergency exits can then be recognized at an early stage. Those in charge of operations are thus able to manage an evacuation in great detail based on the general situation at the time. In serious cases, this "real-time capacity" resulting from the integration of video surveillance can save many lives. With its Building Integration System, Bosch even goes one step further and provides a single web-based control point for monitoring all security, safety and building management systems. It seamlessly integrates fire and intrusion alarms, evacuation, access control, CCTV and building automation systems in a single platform.

However, it is not always possible to ensure such close integration of all components, if only because tenders should be requested for the individual areas independently of one another, for

business or political reasons. This was the case, for instance, in most of the stadiums in South Africa that hosted the World Cup. In such circumstances, the use of standard technologies gains particular importance, as this is the only way to ensure the real integration of video, fire protection and evacuation systems. The use of Ethernet and IP-based solutions is advisable here in any case to allow a uniform infrastructure to be implemented and the individual components to be combined in a unified control center such as the Building Integration System.

While it is true that all stadiums have fundamentally similar safety and security requirements, no two events are really the same. Even in large stadiums, it makes a difference – with all due respect – whether the visitors are Wolverhampton Wanderers or the mighty Real Madrid, not to mention local groupings. In every individual case, safety and security are thus predominantly matters of organization and planning. However, if the fundamental technical components are in place based on the use of standard technologies, problems can be solved much more easily – and implemented more efficiently.

► CONTACT

Bosch Security Systems, Grasbrunn, Germany
Tel.: +49 89 6290 1647 · Fax: +49 89 6290 281647
emea.securitysystems@bosch.com
www.boschsecurity.com



ACCESS CONTROL

Getting Hip

Considering the Transition from Analog to IP-based Surveillance

When it comes to new security installations, Internet protocol (IP)-based systems are growing in prevalence as viable options alongside traditional analog-based approaches. IP is here to stay and it offers a myriad of benefits. But navigating the road to IP requires careful consideration of many factors, from network infrastructure to physical security needs. Jeremy Kimber, Commercial Operational Marketing Leader EMEA at Honeywell Security explains how one can rationalize and navigate a move from analog to IP, especially in the light of tight budgets, undecided industry standards and increased scrutiny on new expenditures.

The answer is complex, although one thing is certain: IP migration is not a matter of if – it is simply a matter of when. Overall, industry research shows that the video surveillance market is approaching a tipping point, where the volume and revenue of IP units will soon surpass analog-based systems. And, as the market moves toward this point, the price difference will fall, and the capabilities and benefits of IP will only continue to grow.

For quite some time, the proprietary nature of IP systems has been a primary barrier to IP adoption, but the tide is changing. In the past year, two industry groups – the Physical Security Interoperability Alliance (PSIA) and the Open Network Video Interface Forum (ONVIF) – have each emerged with the first versions of their IP system specifications. These specifications offer many potential benefits. In the case of PSIA, for example, the industry group's standard aims to establish a primary protocol architecture not only for communication and compatibility between IP-based cameras, but also with access, intrusion and building controls.

Choice of Features

Although market preference is for one agreed-upon standard, this industry development helps further build the case for IP adoption by making it easier than before and laying a solid foundation for shifting to IP-based systems. In light of this inevitable shift, beginning a migration to IP-based systems is a necessary way to future-proof an organization and prepare for when IP will be the dominant form of video. To what degree one should migrate to IP, however, is a question with many possible answers.

The way to most effectively implement IP depends on the needs of an organization and the depth to which an organization is willing to go with an installation. As such, one must consider several factors when considering IP. In terms of pure pricing, the difference between analog and IP is noticeable, with IP carrying a price premium in today's market. IP cameras offer many feature advantages though, such as higher resolution images, multiple inputs, relay output and two-way audio, among others – features that can't be supported by analog video. IP also enables intelligent video capabilities built right into a camera, such as motion detection or people counting features.

IP migration is not necessarily an either-or situation, however. It's not simply a matter of deciding whether an organization should make the full switch to IP or not. In some cases, IP can wait. For example, if an organization is completely analog-based and plans to install around this system occasionally, with infrequent upgrades, then sticking with analog might make sense for the time being. But hybrid solutions, which include a mix of IP and analog-based technology, are one way to begin migrating systems to IP. In many cases, organizations can leverage existing network infrastructure and cabling to install IP-based systems, so the instal-

lation cost can actually be lower than expected due to less cabling.

New Skills

In addition to lower costs, migrations can also be simpler than initial expectations due to the IT infrastructure and expertise in place for the vast majority of organizations today. If an organization has solid IT capabilities and knowledge in place, this network familiarity will make installing IP systems fairly smooth. Overall, whether an organization is looking to make a complete switch to IP or considering a hybrid approach, network accessibility is critical.

In making the transition to IP, it is also critical for organizations to bridge any gaps that may exist between IT and physical security departments and to ensure both sides are involved in all decisions and developments associated with IP installations. IP introduces new components and considerations for security personnel, including networking, which entails a new skill set not typically required of traditional security groups. Additionally, the traditional security aspect is something IT personnel are not as well versed in. Thus, buy-in and involvement from both sides – from planning and implementing to keeping the system up and running – is critical for IP migrations.

Once an organization decides to take on an IP migration, the benefits become apparent. Moving to the network world provides greater storage freedom, since conventional IT types of storage systems are also capable of storing video. IP-based systems offer “edge intelligence,” and in addition to advanced recording and analytics, this provides simple physical benefits, as well. These cameras reduce the amount of cabling and storage space typically required by their analog counterparts. Because the cameras have edge devices and recording solutions, no cabling is needed for routing back to encoders and DVRs. Pushing functionality out to the cameras helps simply ease the physical space problem commonly encountered with traditional analog-based systems.



Cable Saving

Consider the case of PTZ cameras, for example. IP-based PTZ cameras offer advantages over analog versions for several reasons. These cameras are complex systems, and in order to install an analog dome, one would have to run analog, serial and power cables. With IP-based cameras, however, there is no need for different data and video cables. Thus, in addition to benefits including more integration and control capabilities, IP-based cameras can also help alleviate space issues.

In addition to taking up less space, IP-based systems are also good options to consider for situations involving remote access and security. A recent customer example proves just how beneficial IP can be. The company is comprised of many geographically dispersed sites, and it sought to improve the physical security of these locations. To do so, the company installed a hybrid camera solution that combines with access control and intrusion. The system processes analog camera input, stores that data locally and then provides a network interface that allows company personnel to remotely access camera units to quickly verify alarms.

Of course, whenever systems run on a network, organizations must make it a point to ensure the right precautions are in place to keep

systems secure and running smoothly, and IP is no exception. Having the right people in place with the necessary network knowledge – such as proper segmentation of the network to prevent network bottlenecks that can threaten system performance – is critical for IP-based systems. These individuals should be well versed in how to properly manage devices over a network, as well.

Good Old-fashioned Locks

When it comes to system security, both IP and analog-based systems each have their own sets of requirements. Because IP systems are housed on a network, the same IT security technology and considerations must be applied. Incidentally, the threat of security breaches for either type of system often comes down to a question of physical security. Individuals can easily hack into analog systems, for example, by simply cutting cables and installing the proper connectors in order to get a video feed. Also, if a location lacks proper physical security, network-based systems are also vulnerable, no matter how much network security is in place. For example, one classic hacking case involved a person simply picking a facility's locks and then stealing passwords, which enabled him to easily access an IP-based telephone network.

Overall, organizations must apply a complete and thorough approach to securing systems, regardless of their analog and IP-based components. The same is true when considering IP. One must take a look at an IP-based approach from all angles, and consider how and where to apply it to meet an organization's needs. Whether an organization is simply looking to dip its toe in the IP pool and install one camera, or it's looking to make the full analog-to-IP switch, realized value can be gleaned from each scenario when IP is applied correctly, carefully and strategically.



► CONTACT

Jeremy Kimber

Honeywell Security, Bracknell, UK

Tel.: +44 1344 656 989

jeremy.kimber@honeywell.com

www.honeywell.com/security/emea/systems

In Focus: Bosch NDN-498

The Bosch NDN-498 FlexiDome2X day/night IP camera is a CCD full image camera in a compact, very robust and vandalism-protected housing. The cameras have a 1/3 inch CCD chip and a 20-bit DSP with 2X dynamic that help to provide a wider dynamic range and sharper, more detailed images with exceptional color reproduction. FlexiDome2X IP cameras have integrated video movement recognition and can be fitted with an additional processor for video image analysis.



CAMERA TEST

Performance

Performance at 1000 Lux

During the test the camera delivered a generally good and balanced image under good lighting conditions. Colors were clear and without any tint. Slight weaknesses were visible in the contrast, with dark areas of the image in general tending to be too light. Moving and static objects are reproduced sharply and cleanly.

Performance at less than 1000 Lux

With sinking light levels in the test, the contrast reduced slightly, the colors were somewhat weaker, the image remained clear however. Even under poor lighting conditions the image rate remained fluid, moving objects were relatively sharp and detailed and there were hardly any artifacts to be seen. The camera has an automatic day/night switchover although it still provides color information at 0.5 Lux. The colors are only reproduced very weakly at this level of light but the picture stays clear and sharp.

Performance in backlight situations

The camera needs about 2 seconds when confronted with sudden backlight in a dark environment before providing a stable image. In total, the recovery time is around 3 seconds. The CCD sensor allows some smearing that appears in the form of a vertical stripe in the picture. Around 250 Lux the camera needs a comparatively long time (c. 5 seconds), to correctly compensate for the effect of backlight.

Evaluation of bandwidth usage

The camera was tested under H.264 with maximum definition. The bandwidth required at c. 0.5 Lux and also under backlight conditions remained relatively constant at an average of 4 MB/s. Under worse lighting conditions (under 0.5 Lux) the data rate also reduces. The highest level measured was 4.73 MB/s.

Technical data for the camera test

Manufacturer	Bosch
Model	NDN-498
Firmware version	01500411
*Distance from test chart	0.7 m
Objective used	2.8 mm – 10 mm
*Set focal length	c. 6 mm
*Compression method	H.264
*Resolution	704 x 576
Compression	50 %
*Set stream bandwidth	unlimited
Measured frame rate	24 fps
Average measured bandwidth	3.35 MBit/s

The camera was integrated into the test system with the "default" settings and correspondingly modified with the test criteria listed above

Assessment with differing illumination conditions

Criteria Lux values	1000 Lux	100 Lux	10 Lux	0,5 Lux	0 Lux + BL1*
Colours	2.5	2.5	2.5	3	b/w
Contrast	2.5	2.5	2.5	3	–
Sharpness	2.5	2.5	3	3	2
Motion sharpness	2	2	2.5	3	2.5
Image noise	2	2	2.5	3	2
Compensation time for backlight	–	–	–	–	2.5
Backlight characteristics	–	–	–	–	–

Assessment according to the following grades: 1 (excellent), 2 (good), 3 (average), 4 (satisfactory), 5 (limited), 6 (poor)

*Average value.

Summary

The vandalism-protected PoE dome camera with day/night switchover impressed during the test with a good and balanced image quality, even under weak lighting. As well as two H.264 image streams, the camera can also simultaneously deliver an MJPEG stream. It is therefore possible to use different streams for live viewing, archiving and video analysis.

NEW SERIES:

Test the best!

Two Impressive Dome Cameras – a Comparison

Together with Seetec, GIT SICHERHEIT has tested both current and new video cameras in the test lab of the Hardware Competence Centers of Seetec under controlled conditions. The Hardware Competence Center was formed because manufacturer's own data and the features of network cameras were often established under different conditions and were not reliable facts when put into practice. These results provide a valid basis for the planning of IP video projectors and help to prevent unpleasant surprises. Video sequences are created for the tests under various defined light situations and then evaluated. Both movement in the picture and night or backlight situations are taken into account.

Performance

Performance at 1000 Lux

Under good lighting conditions the camera provides a generally balanced image. The colors were reproduced neutrally and without any tint, although the saturation was sometimes too low. The contrast is good, but there are some weaknesses in the focus. Details in the background can be blurred and compression effects can be seen in moving objects in the form of blocks (pixelation). Moving objects are shown without any smearing.

Performance at less than 1000 Lux

The camera reacts quickly to changes in light, it delivers a largely good contrast image and color quality and focus do not change significantly by sinking light levels down to around 10 Lux. The image rate remains fluid, moving objects are correctly reproduced and mostly without any smearing. At 2 Lux and below the image sharpness reduces once more and there is an obvious loss of detail, also with moving objects. There is however no image noise. The camera has an automatic day/night switchover, but still delivers color information with acceptable contrast also under weak lighting.

Performance in backlight situations

The camera provides a stable image after about 2.5 seconds when confronted with sudden backlight in a dark environment. Background details are still visible even under poor general illumination. There is no smearing effect but significant reflections can be seen. The spill from a backlight source is comparatively small and under good lighting conditions is limited to the area of the light source.

Performance in use: bandwidth measurement

The camera was tested under H.264 with maximum resolution. The bandwidth usage lies on average at 1.73 MB/s. The reducing sharpness under 2 Lux can be explained by a much lower data rate in this range. A maximum of 2.58 MB/s is reached against a backlight source.



In Focus: Ganz ZN-DWNT 350VPE

A member of the GANZ IP range of H.264 IP Mini domes, the ZN-DWNT350VPE Wide Dynamic Range camera is available throughout Europe through CBC. The range includes Vandal resistant dome cameras in colour, true day/night and Wide dynamic range options. Built to IP67 standards using a robust metal housing or polycarbonate on the internal options, the camera offers resistance to weather and vandalism. The cameras feature a combination of high-resolution video images and a low data rate. They are equipped with a sensitive 1/3" CCD sensor providing 550TVL. In addition, the variable lenses of the day/night versions are infrared compensated to minimize focusing errors when used under IR light. Optional onboard Video Analytics is available on the entire range.

CAMERA TEST



Technical data for the camera test

Manufacturer	Ganz
Model	ZN-DWNT 350VPE
Firmware version	1.02.03
*Distance from test chart	0.6 m
Objective used	2.8 mm – 10.5 mm F1.2 DC auto Iris
*Set focal length	c. 7 mm
*Compression method	H.264
*Resolution	704 x 576
Compression	ca. 50 %
*Set stream bandwidth	unlimited
Measured frame rate	24 fps
Average measured bandwidth	1.73 MBit/s

The camera was integrated into the test system with the "default" settings and correspondingly modified with the test criteria listed above

Assessment with differing illumination conditions

Criteria Lux values	1000 Lux	100 Lux	10 Lux	0,5 Lux	0 Lux + BL1*
Colours	3	3	3	3,5	b/w
Contrast	2,5	2,5	2,5	3,5	–
Sharpness	3	3	3	3,5	3,5
Motion sharpness	2	2	2,5	3	3
Image noise	2	2	2,5	3	3
Compensation time for backlight	–	–	–	–	2,5
Backlight characteristics	–	–	–	–	3

Assessment according to the following grades: 1 (excellent), 2 (good), 3 (average), 4 (satisfactory), 5 (limited), 6 (poor)

*It is possible to achieve improved picture quality by adjusting various parameters on the camera itself.

Summary

The dust and splashproof PoE dome camera with day/night switchover was impressive during the test with its good recovery and clear presentation of moving objects. It has an I/O port and an audio input/output. The camera supports video analysis functions from twist protection to the recognition of deposited or removed objects (optional). The camera corresponds to the ONVIF specification.

Entry Level 4-Channel H.264 DVR

Samsung has introduced an entry level 4-channel Digital Video Recorder (DVR) for small retail, of-



ice and domestic environments. The compact SRD-450 is equipped with a range of features including the ability to record high quality CIF video in real time across all channels, with the options to record up to 4-CIF over selected channels, and single channel audio recording. The DVR also provides users with the option to remotely view live or recorded video over the Internet via a browser, even on a smart phone, and thanks to the utilization of 'network-friendly' H.264 compression; the DVR makes the most of available bandwidth to display quick and clear video. The use of H.264 compression also maximizes the amount of video which can be stored on the SRD-450's expandable 500 GB internal hard disk drive. To further make best use of the internal hard disk drive, the recorder can be programmed to only record if activity is detected by its Motion Detection feature, whilst recorded video of any important incidents can be easily backed up via a USB output using an easy to operate search facility.

STESecurity@samsung.com

Readers and Biometric Access Control for China

Sebury Technology and Switzerland based Legic Identsystems have announced a license partnership. This will result in access control solutions and biometric readers for the Chinese market. Sebury is now able to provide state-of-the-art and flexible security solutions, which meet the ever-growing demand for high-end access control readers in China. Sebury Technology's reading devices are installed in time and attendance recording systems as well as in biometric applications. "The collaboration with Legic allows us to satisfy the demanding needs of our customers offering a technology that complies with advanced security standards," says Alick Wang, General Manager of Sebury Technology. "We strive to strengthen our worldwide business activities and are convinced that the partnership will support us to establish sustainably in global markets."

info@legic.com

Multi-application Campus Card for Chinese University

Tianjin Polytechnic University (TJPU) has decided on a partnership with Switzerland based Legic Identsystems. Its School of Computer Science and Software Engineering will now be able to upgrade more than 3000 POS terminals to the latest Legic Advant technology and to develop new terminals and access control readers for the whole campus. By integrating different elements of university life, the institute benefits from increased security, flexibility and service for students and staff. Tianjin Polytechnic University has already been using the technology to manage payment processes and access control on the campus. With the partnership agreement, TJPU now can trade on the migration to the cost-efficient technology, which also meets advanced requirements in terms of security. It enables an easy integration of different solutions but also allows for the customizable adaptation to new or modified applications.

info@legic.com

Handling Alarms Mobile

Genetec's Security Center Mobile app is available. This new feature of the manufacturer's unified security platform, the Security Center, enables operators to connect back to their platform over any IP wireless network with Blackberry and Apple devices. It further boosts operational efficiency by offering operators and security guards the ability to remotely monitor and control different aspects of their video surveillance and access control systems while on the move. Jimmy Palatsoukas, Senior Product Manager: "Security personnel never know when an emergency call will come in, or when a critical situation will arise. Security Center Mobile lets them handle real-time alarm notifications from their mobile devices, offering an expeditious response in any situation."

Klnington@genetec.com

Clean, Safe, Efficient

Inergen Plus from Total Walther is an extinguishing system that fights fire effectively, safely and in an environmentally friendly way, leaving no residues. Developed from the field-proven Inergen inert gas extinguishing system it offers a new constant pressure regulation feature, giving it greater operational reliability and fire suppression efficiency whilst simultaneously allowing customers to save on installation and infrastructure-related costs. The new gaseous extinguishing system works on the principle of oxygen displacement using Inergen – an extinguishing agent comprising three naturally occurring inert gases: nitrogen, argon and carbon dioxide. In case of an alarm, the connected Fast 2000 fire detection and control system will, after visual and audible signals, activate a primed control gas cylinder, which opens the valves of the extinguishing agent cylinders pneumatically and, at the same time, supplies control pressure to the individual pressure control valves on the cylinders. The pressure control valves are activated by adjustable control pressure, which can be set to either 25, 40 or a maximum of 60 bar, according to the pipe network pressure required, and reduce the 300 bar cylinder pressure accordingly. The extinguishing gas is able to flow through the manifold and into the nozzle pipe network at a constant rate and pressure. This prevents any short-term pressure peaks at the start of the extinguishing process. As a result, the pipe diameter and wall thickness and the purging pressure release surfaces can be sized more economically.

www.totalwalther.de

The Smallest High-Resolution LPR Camera

Genetec has launched the AutoVu SharpX, the world's smallest high-resolution license plate recognition (LPR) camera. Until now, law enforcement agencies looking to invest in advanced LPR tech-



nology were forced to compromise between size, reading performance and value. LPR cameras with superior read rates are typically large, attracting vandals and often occluding the light bar. Until now, smaller LPR cameras have not read as well, often requiring agencies to install multiple units to obtain adequate performance. The new AutoVu SharpX, designed specifically for mobile law enforcement applications, eliminates the need for compromise. Standing at just 1.65 inches tall, the AutoVu SharpX is the smallest specialized high-resolution LPR camera on the market today. The AutoVu SharpX achieves the industry's highest plate capture rates by providing two to three times higher resolution than other solutions. Higher resolution per plate image means better accuracy and improved readability in bad weather, with dirty or obstructed plates, or at difficult angles. More than that, the AutoVu SharpX is capable of reading up to differential speeds over 200 MPH (320 km/h), across three lanes of traffic.

www.genetec.com

Video Trickle Feature

Genetec announced the availability of the Omnicast Video Trickle feature. This feature significantly enhances the flexibility of video archiving and optimizes bandwidth usage during peak and off-peak hours. The manufacturer leveraged the edge-recording capabilities of IP cameras and encoders of selected vendors to develop a feature that not only records and stores video on the edge, but that also allows segments of video to be hand-selected for long-term storage on Omnicast's Archiver. The Video Trickle feature is available in version 4.7 of Genetec's video surveillance solution, Omnicast. "Reliability is one of the most important aspects of video surveillance for many customers," says Francis Lachance, Product Manager at the company. "Our aim was to further enhance the reliability of video surveillance and video archiving. We worked closely with our partners' engineers to leverage each other's expertise and innovative technologies and are very happy with the result."

Klnington@genetec.com

CCTV

The Most Secured Building in the Country

High Security in the Palmares Technologies Building

In the West African country of Benin stands the Palmares Technologies Building, the most secured building in the country. A provider of high security systems and identification solutions for the Benin government and other West African countries, Palmares Technologies itself demanded an advanced security solution for both interior and exterior building protection. According to the motto "Security and safety first," Palmares Technologies was looking for the highest security level solution with the lowest maintenance constraints. Reliability was also a primary concern in a region with harsh environmental conditions.

A joint Schneider Electric-Pelco effort, involving Gregoire Viasnoff and Jean François Riutort of the Schneider Electric Project & Engineering Center (PEC) EMEA, and Najah Benzina and Ali Abdelkader from Pelco Africa, supplied a complete integrated solution. "We used the extensive Pelco product line associated with the low current Schneider Electric offer in order to provide a complete and cost-effective solution that was compliant with all the customer



requirements," explained Viasnoff. In the end, the installation included a Pelco Endura system, Sarix HD cameras, Esprit and Esprit Thermal Imaging positioning systems, and Spectra IV dome systems. Cameras and video analytics were configured to offer the most comprehensive security system possible for the Palmares Technologies Building. The Endura solution is complemented by two control rooms fitted with Pelco LCD display monitors, APC UPS, Sarel Cabinet and Infra + wires, all integrated and commissioned by Schneider Electric Project & Engineering Center.

Video, Thermal Imaging and Intrusion Detection

Many different facets of security went into this high profile installation, ranging from thermal video and analytics to intrusion detection and monitoring systems so as to immediately identify

who is entering and exiting the building. Also deployed is what is referred to as a 'gateway' system that allows the Palmares Technologies CEO to view up to four simultaneous video streams remotely from anywhere in the world over any Internet connection. The result is his ability to have complete situational awareness over his building complex. The system is operated around the clock by dedicated security professionals allowing for immediate action if a situation presents itself.

"It is no surprise that Palmares Technologies, a very strong player in the West African security market, selected Pelco, because of its high image quality, extended product line and robust IP solution," explains G.Viasnoff. With this great success, Palmares Technologies and Schneider Electric are now proposing to secure other high profile public buildings in Benin and West Africa, such as the International Conference Center of Cotonou, the Cotonou Harbour, the International Airport of Cotonou, the city of Cotonou and the presidency of the Republic of Benin with complete end-to-end Pelco solutions.

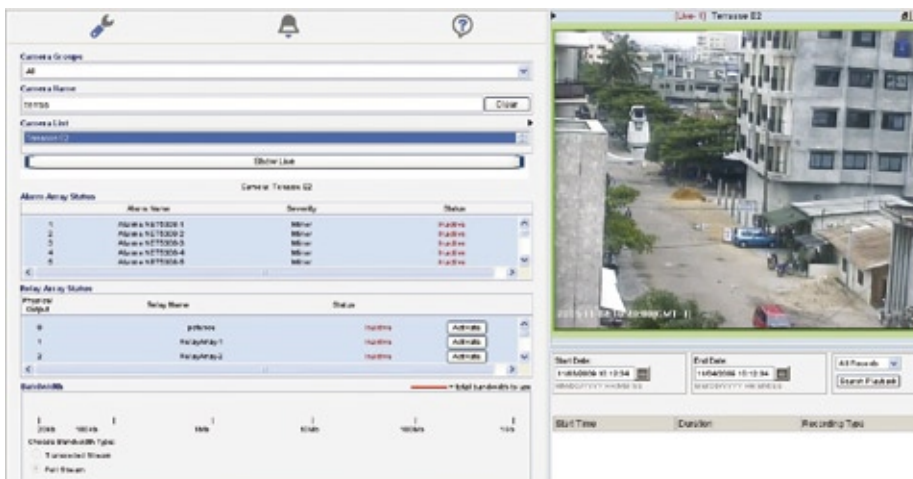

▶ CONTACT

Erin Murray

Pelco, Clovis, CA, USA

Tel.: +1 559 292-1981 · Fax: +1 559 943782

www.pelco.com



SECURITY FOR HOTELS AND CASINOS

Surefire Winners

Germany's Most Modern Casino – Also Right Up-to-date in Security Technology

The City Palais in Duisburg has been one of the lighthouse projects in the modernized city center since opening in 2007. As well as a very varied choice of gastronomy and shopping, a top class casino attracts visitors to Duisburg. The Westspiel Group is the operator and, not only in the Casino Duisburg, has demanded the highest quality of furnishing and design but also the best gaming technology and security equipment. Video surveillance, building management, alarm management and fire protection are all combined in a contemporary security concept.

Seven Casinos, Three Branches, 1.5 Million Visitors Annually

The Westspiel Group provides the framework for gaming and culinary delight in seven casinos countrywide as well as at three branches located in Aachen, Berlin, Bremen, Bad Oeynhausen, Dortmund-Hohensyburg, Duisburg and Erfurt. The Casino Duisburg is a hyper modern gaming house with 18 tables for American Roulette, eight Blackjack tables, four Poker tables and 24 multi-roulette clients that draw many visitors from the local community and further afield as well as from abroad. With c. 700,000 visitors annually, it is the busiest casino in the region and is

also leading the way in security technology. The concepts that have been proven here are being successively introduced at other company locations.

The newly-formed Security Unit is responsible for the integrated security concept that combines all the aspects of security, alarms and building services. Naturally all security measures serve in the first instance to protect the company and visitors from attacks and fraud. The rapid and quiet settling of disputes at the gaming tables is just as important for the Westspiel Group as the positive image effect from their pro-active approach and their transparent communication on the subject of security. "We want to be market-leader in matters of security", is the motto here.

Video Surveillance Forms the Basis

As in every gaming house, video surveillance cameras provide the backbone of the security concept also in the Casino Duisburg. Guests play at 30 tables and 354 gambling machines in the rooms of the casino that cover a total of 8,100m². A comprehensive system was required to cover this area that covers the gaming areas as well as the administrative floors. It was no easy task for the Panasonic Premier Integrator ACC always to install the cameras so that they could fulfill their duty without negatively affecting the exclusive internal architecture. As the casino works closely together with the local police it was also necessary to ensure that they would have the optimum opportunity for investigation and could obtain conclusive recordings.

In general, cameras are used in the slot machine casino on the first floor for surveillance of each of the 354 machines. In the classical gaming room on the second floor two cameras cover each gaming table. Some dome cameras add to the surveillance of the whole area. A particular challenge in every casino is the requirement for very high quality image material. Very high quality pictures are particularly important at the nerve points. High definition Panasonic WV-SP306 IP cameras from the new Ipro series are used for quick and unequivocal settling of disputes at the gaming tables and at the cash desks. The correct location of the cameras is absolutely vital here: on the video recording the casino administration must be able to check every chip spent because there are many different chips, each with a different Euro value. A detailed documentation of the playing cards is also critical at the poker table. Regulations dictate that the cameras must be mounted absolutely vertically and may not be angled so that irregularities may be efficiently monitored without showing the faces of the guests. Accurate color reproduction and HD resolution were the deciding factors for the choice of Panasonic Ipro cameras because the value of a chip can be checked and confirmed in the recorded material – for example if a player is of the opinion that he bet a different amount than that used by the Croupier to calculate the winnings. The high definition of some slightly offset cameras meanwhile also permits the height of a pile of chips and therefore also the number of chips played to be established and documented.



The HD cameras provide highly detailed images of the gaming tables



The security measures are hardly noticeable

The surveillance system must also provide an overview of the entrance area, due to the prohibition of the use of biometric readers, to be able to control access of the casino's customers. The reception and the entrances to the gaming machine casino and classical games are observed so as to enable security personnel can immediately recognize suspicious behavior.

Flexible Solution from High Quality Infrastructure

A great deal of importance was placed on an up-to-date data transmission system and a flexible memory solution right from the beginning. In the original proposition, ACC specified a total of 242 analog cameras. In the meantime, the most critical points have been equipped with the latest IP cameras and all cameras incorporated into a complete hybrid solution. Barox, a company specialized in cabling services, installed the optical fiber based signal transmission system that will also be able to handle increased bandwidth demands in future. A total of 61 WJ-HD716 digital video recorders from Panasonic were specified to record video signals in the initial installation that would enable the casino management to save the recorded material for the legally required minimum of up to seven days. This has since been enhanced by 23 IP-capable WJ-ND400 Panasonic network recorders.

In the Control Room: Everything Under Control

The operators of the Casino Duisburg are particularly proud of the highly modern control room

in which all security-related data come together and from where up to four people can watch what's happening around the clock: not only the data from the video surveillance but also the signals from the access control system, the building management and any alarms (manually triggered alarm switches, fire alarms or intruder alarms) arrive in this room.

Signal and data management takes place with the help of the Winguard software from Advancis. A big advantage here is the synchronization of the video images with other events within the building, such as the data from the access control system or any triggered alarms for example, which causes the image of the corresponding camera to immediately appear on the management system monitor. But from the point of view of the operators, the linking of the building's systems also brings direct commercial benefits. The reduction to just one system for management means less acquisition costs, lower operating costs, less space needed for monitors, PCs, servers or racks, and less training and work for the operators. With the help of the Winguard system, the content of each of the monitors can be individually adjusted and recently an optimization to reduce the transmission bandwidth has reduced the server CPU load.

All security-relevant information is shown in the control room on a large Eyevis wall and numerous Eizo monitors that are controlled by the Panasonic WV-CU650 system controller. The operating personnel has praised above all the easy and intuitive control and,

because of the easy operation, can concentrate on their prime job of supervision.

The opinion of those responsible in the Security Unit at Westspiel is very positive. The powerful surveillance system guarantees that the Casino Duisburg can ensure security and fairness for its guests when playing and unrestricted enjoyment of the unique atmosphere. It is remarkable in these times of 'best price offers' that the relation-

ship between the customer, his installer and his suppliers has developed in the meantime to a real security partnership.

CONTACT

Martin Peters

Panasonic System Networks Europe

Tel.: +49 40 8549 3171

Fax: +49 40 8549 2856

martin-harold.peters@eu.panasonic.com

www.cctv.panasonic.de

MINTRON

High-Definition Low-Light

1080p/720p 50/60fps Camera



HD-IP CAM

- HD 720p Multiple-streaming
- Codecs: H.264 /MPEG-4 /M-JPEG
- CVBS



Megapixel Camera Module

- Image sensors: 1.3-3M CMOS/CCD Sensor
- Built-in AFM926-EJ-S/Memory
- Digital video output: YUV 4:2:2 16 Bit (SMPTE 274M/296M)
- CVBS output: 560TV or 700 TVL (NTSC / PAL)
- Image adjustable: Peak/BLC/XDR/3D DNR/A.E.S./ DC-IRIS/removable IR-Cut
- Communication: RS-232C/OSD
- Low power consumption



3M DSP



3G-SDI CAM

- Uncompression video: 720p/1080p
- Video transmission based on coaxial cable
- Bit rate: 2.97Gb/s SMPTE 292M/424M
- One cable (Video/Audio/RS-232C/Power embedded)
- CVBS

AutoTronics Taipei
L518 (6 booths)

SecuTech Expo 2011
April 20-22 / Taipei, Taiwan
Booth # N712-N715

MINTRON ENTERPRISE CO., LTD.

No.123,Wu-Kung 1 Rd., Wu-Ku Industrial Park, Taipei (248), Taiwan
Tel : 886-2-22990277 E-mail: service@mintron.com.tw
Fax: 886-2-22989375 Web : www.mintron.com Skype: mintron3601

ISO-9001
ISO-14001
RoHS
QC080000

CCTV

Small, Smart, Green

How Hard- and Software Interact in an Optimal Way – Interview with Dieter Dallmeier

“The Smatrix fits in perfectly with the ‘Green Global Security’ philosophy of Dallmeier”



The Regensburg company Dallmeier has always been well known for pioneering spirit and innovations. Dallmeier now presents a new Video appliance. We interviewed Dieter Dallmeier, chief executive and company founder about the background to the new appliance.

GIT SECURITY: Mr Dallmeier, what exactly does the term “Appliance” mean?

D. Dallmeier: To begin with, “appliance” is a common term in English, used in daily language, which is often translated as “device” or “application”. In the IT world however, “appliance” is a technical term. An appliance is distinguished by the fact that it offers an optimal interaction between hard- and software, that means hardware and software are perfectly adapted to each other. An appliance is no “all-rounder”, but instead is intended for a single task area – that is controlled perfectly. Take an everyday example: With your washing machine, you neither telephone nor make coffee. But for washing your jeans, there is nothing better suited for it than the washing machine.

So there are also separate appliances for different areas of use?

D. Dallmeier: Exactly, in IT there are standard appliances such as mail-, spam- or firewall appliances. Similar to this, we have developed a VideoIP appliance, which is specially designed for video surveillance purposes; for example via an elaborate hardware concept with extremely fail-safe components or with hard disks, which are optimised for continuous operation (24/7) and for saving image data. For you can easily imagine that an appliance which is designed for handling emails for example, cannot process large image data. With our VideoIP appliance, named Smatrix, we have not taken a server or storage “off the shelf” and used it for video surveillance (a purpose that it was not intended for); instead the device is developed and designed from scratch for its specific assignment. And of course, the Smatrix, like our complete product range, is produced in Germany.

Is the installation of the appliance time-consuming?

D. Dallmeier: No, because the Smatrix is completely pre-configured, that means all the functions are already installed on the device. Just connect to the network, turn on the power sup-

ply, and it’s ready. In a few minutes therefore, the appliance is ready for use.

What is the maintenance work like?

D. Dallmeier: Maintenance and repair work can be done while the system is running and therefore requires no downtime. The Smatrix is HotPlug and HotSwap compatible, the changing of the hard disks can be carried out quickly and easily on the front of the device.

What areas of use is the Smatrix suited for?

D. Dallmeier: The Smatrix is the ideal solution for any project size, be it 10 or 10,000 cameras. The system is left to expand and scale at your will. It grows with your demands and offers long term investment protection!

You promote the Smatrix with the slogan “small, smart, green”. Let’s begin with the first statement, the Smatrix is particularly small?

D. Dallmeier: The Smatrix is just two height units and offers space for up to 24 channels at a time. These are variably configurable; therefore it is left to you, whether you want to connect only network cameras, only analogue cameras or both in hybrid joint operation. In contrast to standard appliances from the IT world, the Smatrix stands out due to its small depth, which means it fits comfortably in a standard 19” rack space. Thus, space saving in larger systems can be realised.

Why “smart”?

D. Dallmeier: Smart, because the Smatrix, despite its small size, stands out due to the highest efficiency and reliability. The elaborate hardware concept ensures long term disposability of the system – the service life is up to 30% higher than standard DVRs/NVRs with storage!

“Green” surely refers to the topic of the environment?

D. Dallmeier: Correct, since the Smatrix fits in perfectly with the “Green Global Security” philosophy of Dallmeier. It especially stands out due to its high energy saving: a sophisticated system architecture and the use of 2.5” hard disks make extremely low power usage possible – up

smatrix
SMALL · SMART · GREEN



to 70 % less than conventional DVR/NVR with storage! And because of the low heat emissions, cooling and air conditioning costs can be saved – up to 75 % less than with standard devices. Less energy use and lower heat emissions not only helps save the environment, but also the money in your wallet!

You talk about the “Green Global Security” philosophy, what exactly is it?

D. Dallmeier: Environmental protection is a major concern for Dallmeier and in this regard the company’s efforts far exceed the legal regulations. Waste avoidance and low energy usage during the production processes, as well as use of recyclable materials equally belong to the “Green Global Security” philosophy, as does the orientation of the product development towards environmentally friendly and ecologically efficient devices.

And one last question: In this interview you have often used the term “IT”...

D. Dallmeier: Physical security, which also includes video surveillance, and IT security are increasingly growing together. “Convergence” is the often-quoted key word here. CCTV and IT, previously two separate sectors, are merging together more and more. So, for example, IT computer retailers are evermore included in the sale of video systems. That development was not least driven by the opening of video systems, for instance via open interfaces, as well as by the

operation of systems over standard network infrastructures instead of closed CCTV networks. Video is also more often seen as an additional component, which is operated over an already existing network by the customers. With our VideoIP appliance Smatrix, we have kept up with the changes and developed a product that satisfies both the requirements of video security technology and the IT world.

Mr Dallmeier, thank you very much for the interview.

► CONTACT

Dallmeier electronic GmbH & Co. KG,
Regensburg, Germany
Tel.: +49 941 8700 0 · Fax: +49 941 8700 180
info@dallmeier.com · www.dallmeier.com

RFID-Technology for Innovative Access Control

proxMagic®

• **High Flexibility**

One reader for all proximity technologies.



bioProx®

• **Double Security**

Contactless access control and biometric verification.



tranSpeed

• **High-Speed Access Control**

Vehicle access and car park management for indoor and outdoor installation.



proxSafe®

• **Perfect Control**

Secure and electronically recorded management of keys and valuables.



deister electronic

deister electronic GmbH
Hermann-Bahlsen-Str. 11
D-30890 Barsinghausen
Tel: +49 (0) 51 05 - 51 61 11
www.deister.com

The RFID Company

DVR with Real Time Recording

Lilin has launched its premium 4 Channel DVR-304 Series Digital Video Recorder. With Real-Time (25FPS per channel) recording the unit can provide quality-recorded images at D1 resolution. Installers and users will find many familiar functions as the easy to use GUI is based on previous products. Simple to operate, the DVR can be controlled by the front panel buttons, IR remote control and also a mouse. All functions, such as live video and playback can be accessed across a network using Internet Explorer or the manufacturer's own CMX software, supplied free with the unit. The Series is very simple to use and benefits from a number of intuitive features. For example, weighted recording maximizes hard drive space by lowering the frame rate per channel until an alarm is activated. That channel then reverts to Real-Time recording for the alarmed event. With SVGA, composite and a HD Monitor output of 1,920 x 1,080i, the unit has a variety of viewing options. A built-in power saving feature enables the DVR to put your monitor into standby mode. A range of user friendly Apps are available for a number of compatible Smartphones, including Iphone, Ipad and Blackberry devices.



sarajane@meritlilin.com

People Counting Network Dome

Samsung has introduced a network dome, which incorporates people counting. Although developed in response to demand from retailers who require a reliable tool for monitoring footfall for marketing, merchandising and security purposes, the SND-3080C network dome is likely to be of interest to a wide range of other market sectors including transportation, libraries, museums, car parks, sporting venues and leisure facilities. The people counting feature is part of the dome's video analytics capability and it works by simply drawing a virtual line or box area in a certain part of the scene. The dome then counts the number of people that cross the line or enter the box and the data can then be transmitted in XML or CSV formats at selected intervals to a predetermined location. The dome features true day/night operation with a built-in IR cut filter and can capture and transmit very high quality images up to 4CIF (704 x 576) resolution in real time cross a network.



STESecurity@samsung.com

H.264 Network Dome for all Weather Conditions

Panasonic System Networks Europe has launched the newest addition to its Ipro Smart HD range of network dome network cameras – the WV-SW395. The camera uses Uniphier technology, enabling simultaneous H.264 (High-profile) and JPEG video streams over IP for monitoring and high-resolution video recording. The newly developed 1.3 megapixel double speed MOS sensor with full frame transmission of up to 30 fps at 720p HD resolution, gives high quality images at an impressive 1,280 x 960-image size. The manufacturer's weather-proofing fan, heater and sun shield mechanisms allow for changes in temperature between -40°C and +50°C and the integrated dehumidification device circulates air within the dome removing condensation to ensure perfect camera images in all conditions. The new dome camera also has an IP66 rated water and dust resistant housing – extending its lifespan, minimizing intervention/servicing and therefore reducing total cost of ownership.



tom.gibson@eu.panasonic.com

Ethernet Transmission

Comnet Europe has introduced the Comworx VL – Value Line to satisfy the demand for a cost-effective line of Ethernet transmission products. This line consists of: Managed Ethernet switches;



Ethernet media converters; Ethernet media converters with 60 W PoE; Ethernet over coaxial cable media converters; Ethernet over unshielded twisted pair (UTP); and Managed switches for Gbit and 100 Mbit up to 24 modular ports. The line is the company's entry into Ethernet products that are commercial-rated and designed for benign operating environments and comes with a 5-year warranty. The new line of media converters, Ethernet-over-Coax and managed Ethernet switches has been designed for applications where functionality and performance is mandatory, but cost is a significant consideration. The manufacturer has also developed a cost effective product line for analogue video, audio and data transmission. This consists of 1Ch Mini Video With Contact Closure; 4Ch Quad Video & Contact Closure Receivers; 4Ch & 8Ch Multiplexers; 4Ch & 8Ch Multiplexers with 2Ch Data; RS232/422 Data Transceivers; and Audio Transmission with Contact Closure.

info-europe@comnet.net

Thermal Imaging for Law Enforcement

Flir Systems has launched its BHS-Series of portable thermal imaging cameras for law enforcement applications. The cameras see clearly in total darkness. They give law enforcement officers, security patrols and any other person that needs to see at night without being seen himself, the information needed to make critical decisions, enhance mission effectiveness, maximize operational capabilities and improve safety. The Series are shock-resistant thermal imaging cameras. They produce a crisp image in the darkest of nights. Security professionals and law enforcement officers can see suspects in total darkness, through smoke, and light foliage. The Series complement the successful HS-Series. The HS-Series are monoculars. Many users requested bi-oculars for their missions. That is why FLIR Systems developed the BHS-Series. Bi-oculars are less tiring to use for the eyes than a monocular. By using a bi-ocular the ability to detect faint objects is enhanced. This means that you have more chance to detect small objects against the background. It is also easier to hold bi-oculars steady when looking at an object.



flir@flir.com

Industrial Fire Protection

Minimax provides one-stop fire protection concepts – including fire extinguishers, intelligent, automatic extinguishing systems, and complete fire protection. At Intersec the full service provider underscored its know-how and wide range of products. Many branches of industry involve special fire risks thus presenting special requirements for the fire protection concept. In power plants, substations, steelworks, desalination plants, the petroleum and chemical industry as well as in hospitals, archives and containment buildings – wherever there is a risk of fire, Minimax is there, protecting people, machines, buildings and the environment. As an international full service provider the company not only provides consulting, engineering and installation, it also offers the full range of contemporary fire protection equipment, including systems designed for special risks as in power plants, as well as an extensive services portfolio. Moreover, it has a comprehensive services network equipped with state-of-the-art technology with an integrated fault monitor management that can be reached 24 hrs/day.

www.minimax.de

Internal Varifocal Dome with Built-in IR LEDs

The latest addition to the Samsung varifocal dome range, the SCD-2080R, is an internal dome with built-in IR LED illuminators. It is designed to provide a stylish and competitively priced option for a wide range of applications including offices, retail outlets, petrol stations and hotels. It is a true day/night camera with a removable infrared cut filter which, thanks to its built-in 12 IR LEDs, has the ability to capture clear images of objects which are up to 20 m from the camera, even when the area is in total darkness. The intensity of the IR LEDs are automatically adjusted depending in the distance of the object, which eliminates bright highlights and therefore ensures a perfect balance of the foreground and background within an image. Thanks to the inclusion of Samsung Techwin's W-V DSP chipset the dome is able to capture high-resolution color images at 600 TV lines during the day and superb quality 700 TV lines monochrome images at night. This makes the dome particularly suited for monitoring locations that require 24-hour surveillance, such as fire exits and computer server rooms.



IP Fixed Dome Cameras with Audio Functionality

Basler's new IP Fixed Dome Camera models will be equipped with an audio function and with a new multimedia video processor. This processor technology is already being used in the manufacturer's current IP fixed box camera line. First models with resolutions of up to 1.3 megapixels will be available in the second quarter of 2011. With the integration of audio functionality, both a microphone for audio recording and speakers as part of a public address system can be connected to the camera. When this feature is used, the IP Fixed Dome Cameras cover an even wider area of surveillance than the camera's field of view. The two upcoming dome camera models, the BIP2-D1000c-dn camera and the BIP2-D1300c-dn high definition model, provide real-time video at frame rates of up to 30 fps with MJPEG, MPEG-4, and H.264 compression.



Energy Saving Reader

The Energy saving reader from Paxton Access is now available through Norbain. Designed for use with Paxton Switch2 or Net2 systems, the reader can be used to cut energy bills, save money and lower a site's carbon emissions – bringing customers extra benefits from their access control systems. The reader is designed to retain a users' proximity card, once fitted, it can control the utilities in a building – like heating, lighting and air-conditioning. This means that lights can't be left on by mistake and customers can capitalize on greater control over energy usage on a site, saving them money on bills. The reader can also be fitted to control machinery. This means that use of connected machinery can be restricted to only authorized personnel, who are either qualified or have permission to use the equipment. This helps ensure that health and safety standards are adhered to. It also minimizes the likelihood of accidental damage occurring, and risk to untrained staff.

2D Barcode Reader

IER introduces the IER 602, a 2D barcode and NFC reader, suited for reading mobile devices and enabling passenger self-scanning. With its all-in-one ability to read multiple data formats, the device can be deployed at all passenger touch points: ticket counter, security checkpoint, frequent flyer clubs, service desks, or boarding gates. It can easily identify and track passengers as they move through the process. Flat bed scanners have proved to be the best way to scan 2D barcodes on mobile devices. The large active LCD display brings detailed color graphics and text, guiding passengers to scan their own barcodes, contactless cards, or mobile devices. As more passengers and mobile device manufacturers embrace mobile barcodes and NFC technology, the reader is ready for the airport of the future.

emussard@ier.fr

On-the-spot Identification

Morpho (Safran group) has launched Morpho-Ident, the latest handheld mobile device in its line of criminal justice solutions. Designed for public safety agents and officers in the field, it enables real-time, on-the-spot identification based on fingerprint recognition technology. The robust, pocket-sized device uses state-of-the-art identification technologies. In addition to its modern design and glossy finish, it boasts user-friendly features such as intuitive pictograms, folder management, vibration alert and an easy-to-use keypad. Fingerprints are captured with an FBI certified optical PIV sensor, including real-time automated quality check, and matched against local, national or international databases. Results are displayed on the device's large color LCD screen, giving officers fast access to critical crime solving information. The device can be easily integrated into existing IT architecture without incurring additional infrastructure costs.



Fingerprint Live Scanner Certified

Suprema has announced that the company's latest 'RealScan-10 UID' fingerprint live scanner received certification from the Government of India's STQC (Standardization Testing & Quality Certification) for the country's UID project. The certification is an essential requirement for procurements of the US\$ 4.4 billion UID project and ensures devices to satisfy API specifications presented by UIDAI. The STQC provides quality assurance services in IT and electronics through its countrywide network of laboratories. The compact-sized portable fingerprint live scanner provides range-leading capture speed and clear image quality by using the company's optical image processing technology. The device performs world's fastest image scan rate of over 20 frames per second using powerful internal DSP and image processing technique. "RealScan-10 UID has been specially developed to meet high-level requirements for India's UID project which demands fast and high quality image capturing and extra durability in India's harsh environments. The device features dust and waterproof rugged structure with IP54 certification required by UIDAI," said Young S. Moon, Vice President at Suprema. "Key technology in RealScan-10 UID is based on our in-depth expertise in biometrics and image processing as well as our years of experience in large-scale government and public projects," Young added.

andyahn@supremainc.com

Quality Fire Detectors for 12V Security Systems

The 12V Relay Base from Apollo Fire Detectors allows the company's Series 65 range of commercial-standard smoke and heat detectors to be easily incorporated into 12V home security installations. The base uses a single volt-free changeover contact, and can operate over a range of 9V–15V DC, making it suited for use in 12V applications such as non-latching security systems. In order to operate, the base requires a Series 65 detector. Options from this range include the Optical and Ionization smoke detectors, and various Heat detectors. A jumper on the base's PCB can be set to 'latching' for fire systems, and 'non-latching' for security systems. In latching mode, an alarm state will continue until it is manually reset, whereas in the non-latching mode it will automatically reset both the base and the detector in order to integrate with a security system. As with all Series 65 bases, a 'one way only' fit system is in place, which makes it both easy and safe to correctly fit the detector to the base.



www.apollo-fire.com



FIRE PROTECTION

Hot, Hotter, Hottest

Thermal Imaging Camera Detects Potential Fires at a Very Early Stage

Thermal imaging cameras are used for a wide variety of applications. Thanks to their ability to measure temperatures in a non-contact mode, they can also easily be used for fire prevention. Any industry which has some type of storage area where goods or material are stored is susceptible to self combustion of material. Typical examples of this are storage of splint wood, batteries, waste recycling materials and coal. All these applications have in common that there is a fundamental need to detect hot spots and prevent them from turning into a fire.

Orglmeister Infrarot Systeme is an innovative company in Germany that manufactures and markets the Pyrosmart system, a camera system that can be used for fire prevention. The system will detect hot areas that can lead to a fire at a very early stage. "The Pyrosmart system contains a thermal imaging camera and a daylight camera.", explains Mr. Orglmeister, General Manager of the company. „At the heart of the system is a Flir A615 thermal imaging camera."

"The system can scan a large area. All the separate thermal images that are taken are stitched together by our patented Abirovision system and a continuously updated panorama

image is created. By combining all the 640 x 480 pixels images created by the camera we can build a large thermal image that has up to 9600 x 9600 pixels. The Pyrosmart system can be pressurized so that it can be installed in extremely hot and dusty environments or at any other location." The system has an IP network connection and an alarm output and needs only a 24 V connection to be up and running. The entire system is also extremely easy to control thanks to a touch screen interface.

Detecting Fires

"The Flir A615 is an ideal instrument to integrate into our system thanks to its ability to measure



Hot spots in a waste bunker can lead to spontaneous self combustion and fires

temperatures" continues Mr. Orglmeister. "It can easily detect hot spots which are a first indication that a fire might break out. The user can



The PYROsmart system clearly shows the areas that are susceptible to spontaneous self combustion. The fire monitor will cool these areas down.



The fire monitor in action in a waste bunker.

easily set various types of rules, so if one of these is violated an alarm will automatically go off." These rules can be different and adapted to the industry in which the system is being used. The easiest rule would be for the system to detect a temperature that is above a certain value set by the user. In other cases, for example in a waste incineration plant, a rule could specify that the system just monitors for a temperature increase if no new waste is currently being added. "But this rule would be useless in a recycling plant where waste is being added and turned continuously by loaders. The exhaust pipes of these vehicles cannot be considered as a hot spot, nor can them appearing in the image be considered as a temperature increase so, thanks to intelligent algorithms, the Pyrosmart system can distinguish between the hot exhaust of a vehicle and the early stages of a fire.

Point to Shoot

"Detecting a hot spot that can lead to a fire is one thing. Preventing it from becoming a real fire is another", says Mr. Orglmeister. "It is not always so easy that you can send someone out with a hose to cool down the problem area. Therefore many users and also insurance companies asked us for a system that can not only detect hot spots but one that can cool them down immediately as well. The Pyrosmart system takes xyz coordinates and sends them to a mobile water spray extinguishing system. So a typical situation would be that one of the user-defined rules set in the system is violated and an alarm is generated. The xyz coordinates of the hot spot are sent to the mobile water spray extinguishing system which turns to the direction of the hot spot and starts to put water on it so that it is cooled down and the danger of a fire is eliminated. The cold water spray is tracked automatically by the Pyrosmart system to the exact location of the hotspot. This procedure is patented by Orglmeister Infrarot Systeme. The fire monitor can also be operated manually with a joystick, a necessary feature so that the system can be overruled by firemen. Thermal imaging cameras like the Flir A615 can also see through smoke so that the system will help the firemen to see through the smoke to where the fire is and where they are spraying the water.



Cokes production: hot areas that have not been cooled down can be identified immediately with the PYRO-smart system. In combination with a fire monitor, the parts that are too hot can be cooled immediately.

Hot or Not

The system can be used in a wide variety of situation: various systems have been installed in waste bunkers and waste incineration plants as well as at various locations where cokes are produced. During the cokes production process, coal is heated and needs to be cooled down again afterward with water in order to prevent the entire coal pile burning up. It can happen, however, that certain parts of the coal pile are not being cooled down enough. This means that the coal is still burning, with a corresponding loss of the final product. By using the Pyrosmart system to look at the cokes, hot areas that have not been cooled down sufficiently can be immediately identified and, in combination with a fire monitor, cooled down. The system also ensures that no more water is sprayed than absolutely necessary and only on places where it is needed. Some cokes plants succeeded in bringing the amount of water in their cokes down from 8% to 2%. This means that they are able to deliver more of a better quality product. Taking into account the extra income that is generated from this, the investment in such a system is relatively small.

"Water is sprayed exactly where it is needed and nowhere else. This is in contrast to sprinkler systems that can damage the entire stock of a warehouse. A system taking full advantage of the thermal imaging capabilities of the Flir A615 just sprays water where the fire is breaking out. The cost of a fire is often underestimated; there is not only the loss of material but, even worse in some cases, loss of life. A Pyrosmart system is a small investment to avoid all this", concludes Mr. Orglmeister.

▶ CONTACT

Flir Commercial Systems B.V., Breda, Netherlands
Tel.: +31 765 794194 · Fax: +31 765 794199
flir@flir.com · www.flir.com

For Every Environment

The sensing capabilities and advanced applications of Notifier's Smart 4 system can be set to protect almost any environment. As a result, it will reliably detect fires where other detectors may signal false alarms just because of the environment they are installed in. For example, a steamy shower was the cause of a false alarm in a luxury hotel suite in Frankfurt, Germany. A new product is the 2-loop addressable Pearl panel. Since the German norm DIN VDE 0833-2 no longer limits the number of devices on a loop to 128, the panel will be set up to control an addressable loop with 318 fully isolated devices from the Opal-series. The company also presents an early warning aspirating smoke detection system to include reliable gas detection and environmental monitoring.

info@notifier.de

Lightweight Patient Trolley Stretcher

Evac+Chair International has launched a new addition to its accessories range. The Ministretcher is a simple, effective manual handling solution for lifting and transferring an injured or incapacitated person onto an Evac+Chair so that they can be swiftly evacuated to safety. It is designed for use in confined spaces, stairs or rough terrain making it particularly valuable to venues like stadiums and arenas. Unlike traditional stretchers, the solution is specifically designed to stay with the injured person throughout their journey for comfort and onward travel. It is manufactured from tough, waterproof, washable, reinforced material with a plastic board neck support. The flexible plastic board adapts to the wheelchair and injured person for comfort throughout the entire journey.

info@evacchair.co.uk



Fire Detection for Open Spaces

Xtralis has released its Open-area Smoke Imaging Detection (OSID). It is designed for open spaces where fire detection presents unique challenges and where very early warning is not always the priority. It has performed with great reliability in trials over the past few months and achieved UL and ULC listings. "Xtralis is known for delivering detection solutions without compromise, and Vesda ASD is the most reliable solution for very early warning smoke detection in any environment, including open areas," explains Ghassan Habelrih, senior vice president of fire, strategy and business development for the manufacturer. "But when only standard sensitivity is required, OSID offers the most reliable and cost-effective solution for open spaces because it delivers superior performance to overcome all of the shortcomings inherent to other detection systems currently used in these applications."

www.xtralis.com



Transport system for solar modules in the test center of Q-Cells SE

FIRE DETECTION

Sun without the Burn

Modern Fire Detection Technology Provides Safety in Solar Valley

Alongside other renewable (and/or alternative) sources of energy such as wind, water or geothermal heat, solar energy belongs to those that will play an increasingly larger role in future energy supply. Just as important a role is played by the protection of the energy suppliers themselves.

Unlike fossil fuels such as oil, coal and natural gas, which are available only for a finite amount of time – and on which the present supply is generally based – solar energy is available permanently. The photovoltaic method is used to convert solar radiation into electric energy. The most well-known form of such systems are the solar modules that have been installed on a large number of roofs and which provide a portion of the energy used in the respective buildings. New records are announced regularly from the scientific laboratories when it comes to the efficiency

of the solar modules. According to the 'National renewable energy action plan', the German Federal Government assumes that approximately 38 % of electricity in the year 2020 will be produced by means of renewable energy sources. Today this percentage is already a good 17 %.

Solar Valley

The industrial area in the district of Thalheim in Bitterfeld-Wolfen (Saxony-Anhalt/Germany) near the Halle-Leipzig airport is referred to as "Solar Valley". The production and storage facilities of various companies from the photovoltaic industry are found on the main road there known as 'Sonnenallee' (sun avenue), for example Sovello AG, Q-Cells SE and its subsidiaries Calyxo GmbH and Solibro GmbH. In several development stages over the past few years a 77-hectare technology park was created – Solibro alone increased their production capacity to 135 MWp (Megawatt Peak) which makes them one of the largest solar mod-



'Solar taxi' project: Q-Cells AG is a main sponsor of this idea and sent the solar vehicle for a trip round the world in 2007, starting at their HQ in Thalheim near Wolfen (Saxony-Anhalt).

ule production facilities based on CIGS (Copper-Indium-Gallium-Diselenide) technology. Q-Cells SE was founded in 1999 and has developed into one of the world's largest photovoltaic companies within only a few years. More than 200 scientists and engineers at Q-Cells work on further developing the technology by lowering the related costs both quickly and permanently, thus making photovoltaic products affordable and competitive.

Complex Safety Network

One can easily imagine the disastrous effects a major fire may have in such industrial complexes. The local company of Teltron&Simet was assigned to equip the local businesses with an appropriate security network. Being a partner of Novar, these expert installers use traditional Esser brand products. As of 2011, the installer will be able to look back at over 20 years of successful and positive development in their own competencies in the fields of communication, IT and security technology. The company thus provides an efficient combination which promises a wide range of flexible services – even for large projects.

System Dimensions

The monitoring of the 'Technology Park Mitteldeutschland' covers the buildings of the following companies: the Sovello premises are equipped with three 8008 FACPs, which are connected to 2471 optical smoke detectors, 116 manual call points and 18 aspirating smoke detectors (LRS); the Calyxo premises have three IQ8Control M FACPs connected with 589 optical smoke detectors, 44 manual call points as well as 3 LRS systems; the Solibro company building is monitored by one 8008 FACP connected to 1,289 optical smoke detectors, 92 manual call points and LRS systems; Q-Cells is protected by two 8008 FACPs as well as six IQ8Control C FACPs and seven IQ8Control M FACPs connected to 3,859 optical smoke detectors, 415 manual call points as well as 100 ex-proof fire detectors. All alarm panels are networked via fiber-optic cables. A superordinate Winnmag hazard management system was installed for the entire network that also incorporates the access control and intruder alarm technology from Honeywell Security.

Peter Freitag, Managing Director of Teltron&Simet and in charge of the security system installation, told Ronald Tschentscher, the technical sales consultant for the Esser product line: "It is reassuring to use high-quality products from an innovative and leading enterprise with the certainty that the complex safety monitoring is running flawlessly. This smooth process during installation in large building complexes encourages us to proceed in the same manner in forthcoming projects."

► CONTACT

Joachim Meisehen

Novar GmbH, Neuss, Germany

Tel: +49 2137 17226 · Fax: +49 2137 17366

info@esser-systems.de · www.esser-systems.de



BUYERS GUIDE **LEAD GENERATION**
EVENTS **REPORTS** **NETWORKING**
INDUSTRY NEWS **WEBINARS** **ONLINE-ARCHIVE**
TREND TOPICS
IT SECURITY SECURITY **FIRE PROTECTION** **SAFETY MANAGEMENT** **JOB**
WHITEPAPER **RSS FEED** **PRODUCT INFORMATIONS** **WEBCASTS**

GIT-SECURITY.COM

➤ **GIT SECURITY,**
the leading EMEA print and online media for safety and security

➤ In cooperation with **PRO-4-PRO.com** we present:

- **Buyers Guide**
- **Webcasts**
- **Webinars**
- **Jobs**
- **Online Surveys**
- **Newsletter**
- **Enhanced Search Functions**
- **English Language**

www.GIT-SECURITY.com





Security Management

ABUS Security-Center 

ABUS Security-Center GmbH & Co. KG
Linker Kreuthweg 5, D-86444 Affing
Tel. +49 (0) 8207 / 9 59 90 - 333
Fax +49 (0) 8207 / 9 59 90 - 100
info.de@abus-sc.com · www.abus-sc.com

ABUS Security-Center is one of the leading manufacturers of electronic security technology. As a full-line supplier, ABUS Security-Center consistently markets an international range of products and services for the market segments of intrusion detection and video surveillance.

Alarm Management



ATRAL-SECAL GmbH
Service Daitem
Thaddenstr. 4 · D-69469 Weinheim
Tel. +49(0)6201/6005-0 · Fax +49(0)6201/6005-15
info@daitem.de · www.daitem.de

Radio-controlled burglary alarm systems, radio-controlled fire warning devices, distribution via security suppliers

Facility Security

DICTATOR

Dictator Technik GmbH
Gutenbergstr. 9 · 86356 Neusäß
Tel. +49(0)821/24673-0 · Fax +49(0)821/24673-90
info@dictator.de · www.dictator.de

Drive units, hold open systems and smoke detectors, door control solutions

Security Management



Advancis Software & Services GmbH
Monzastraße 2 · D-63225 Langen
Tel.: +49 (6103) 80735-0 · Fax: +49 (6103) 80735-11
info@advancis.de · www.advancis.de

WinGuard – Integral system for security and building management, control and visualization, alarm management, video management, communication

Be Part of the Section

GIT BUSINESSPARTNER
The Purchasing Section for direct contact

Just send a mail to
heiko.baumgartner@wiley.com

We will be glad to advise you!

Facility Security



GEZE GmbH
Reinhold-Vöster-Str. 21-29 · D-71229 Leonberg
Tel. +49(0)7152/203-0 · Fax +49(0)7152/203-310
vertrieb.services.de@geze.com · www.geze.com

Automatic door systems, security systems, security locks

Security Management

LevelOne is a trademark of Digital Data Group 

Digital Data Communications GmbH
Zeche-Norm-Straße 25 · D-44319 Dortmund
Tel. +49 (0) 231-9075-222 · Fax +49 (0) 231-9075-184
sales@level-one.de · www.level-one.de

LevelOne provides full service – even when it comes to security: A broad range of high quality IP-products, combined with expertise in projects, assure reliable security solutions in all dimensions.

Alarm Management

DIGISOUND

Digisound Electronic GmbH
Oststraße 54 · 22844 Norderstedt
Tel. +49(0)40/526869-0 · Fax +49(0)40/526869-13
info@digisound.de · www.digisound.de

Acoustic buzzers, piezo-electric sounders, electronic beacons, speakers, and transducers

Facility Security

Simons Voss technologies

SimonsVoss Technologies AG
Feringastr. 4 · D-85774 Unterföhring
Tel. +49(0)89/99228-180 · Fax +49(0)89/99228-222
marketing@simons-voss.de · www.simons-voss.de

Digital locking and organisation systems with optional access control and time recording

Security Management

funkwerk 
plettac

Funkwerk plettac electronic GmbH
Würzburger Straße 150 · D-90766 Fürth
Tel. 0911/75884-0 · Fax 0911/75884-220
info@plettac-electronics.de
www.cctv-systeme.com

CCTV, system solution, system integration, video monitoring security, building management

Alarm Management



TAS Telefonbau
A. Schwabe GmbH & Co. KG
Langmaar 25
D-41238 Mönchengladbach
Tel. +49 (0) 2166 858 0 · Fax: +49 (0) 2166 858 150
info@tas.de · www.tas.de

Manufacture and development of: alarm and conference units, VoIP- or ISDN emergency technology, alarm transmission systems



Security Management



Schille Informationssysteme GmbH
Goseriede 4 · D-30159 Hannover
Tel. +49(0)511/542244-0 · Fax +49(0)511/542244-22
info@schille.com · www.schille.com

Facility and building management and security technology, fault and hazard management systems, OPC development, video surveillance systems

Alarm Management



tetronik GmbH
Angewandte Elektronik und Nachrichtentechnik
Silberbachstr. 10 · D-65232 Taunusstein
Tel. +49-6128-963-1 · Fax +49-6128-963-499
info@tetronik.com · www.tetronik.com

broadcasts and alarms, telephone conferences, personal security measures with location tracking and visualisation, one number services and group calls, announcement and open listening services, telephony access services for host systems

Video Technology

ABUS Security-Center 

ABUS Security-Center GmbH & Co. KG
Linker Kreuthweg 5, D-86444 Affing
Tel. +49 (0) 8207 / 9 59 90 - 333
Fax +49 (0) 8207 / 9 59 90 - 100
info.de@abus-sc.com · www.abus-sc.com

ABUS Security-Center is one of the leading manufacturers of electronic security technology. As a full-line supplier, ABUS Security-Center consistently markets an international range of products and services for the market segments of intrusion detection and video surveillance.

aimetis

Aimetis GmbH
Am Prime Parc 7 · D-65479 Raunheim
Tel. +49 (0) 6142 20798 60 · Fax +49 (0) 6142 20798 89
info@aimetis.com · www.aimetis.com
Aimetis Symphony™ is award-winning intelligent video surveillance software that offers a single, innovative, open IP video platform for video management, video analytics, system integration and alarm management.

DYNACOLOR
always watching

DynaColor, INC
NO.116, Jou Tz Street, Neihu, Taipei 114, Taiwan
Tel: +886-2-2659-8898 . Fax: +886-2-2659-8868
info@dynacolor.com.tw · www.dynacolor.com.tw
Manufacturer of IP surveillance and HD-SDI / CCTV products.

HeiTel
DIGITALVIDEO

HeiTel Digital Video GmbH
Stuthagen 25 · D-24113 Molfsee/Kiel (Germany)
Tel. +49(0)4347/903-0 · Fax +49(0)4347/903-400
info@heitel.com · www.heitel.com
Digital Video Transmission and Recording,
Video Management, Monitoring Station Integration

AXIS
COMMUNICATIONS

Axis Communications GmbH
Lilienthalstraße 25 · D-85399 Hallbergmoos
Tel. +49 (0)811 55508-0 · Fax +49 (0)811 55508-69
info-de@axis.com · www.axis.com
Network video equipment – the AXIS IP-Surveillance allows remote access video management

eneo

Eneo is a registered trade mark of VIDEOR E. Hartig GmbH, Rödermark. Distribution via authorized dealers and installers.
info@eneo-security.com · www.eneo-security.com
Products and solutions for video security applications

logiware

logiware gmbh
Alfred-Mozer-Str. 42 · D-48527 Nordhorn
Tel. 05921/7139920 · Fax 05921/7139929
info@logiware.de · www.go1984.de
Software, video transmission systems, security, video, video surveillance systems, digital video surveillance, networking

bwa
endless video coverage

BWA Technology GmbH
Johann-Krane-Weg 37 · D-48149 Münster
Tel.: +49(0)251/289199-0 · Fax: +49(0)251/289199-29
info@bwatech.com · www.mybwa.com
Video analytics and high-efficient, compact H.264/MPEG4 solutions

Be Part of the Section
GIT BUSINESSPARTNER
The Purchasing Section for direct contact
Just send a mail to
heiko.baumgartner@wiley.com
We will be glad to advise you!

milestone

Milestone Systems Germany
Harald Zander, Country Manager
Eltviller Str. 5, 65197 Wiesbaden
Tel. +49 (0) 611 168 5597
Mobile +49 (0) 176 62479674
www.milestonesys.de
Milestone Systems is the leading global developer of open platform IP video management software. XProtect™ is a powerful surveillance solution that is easy to manage and supports the widest choice in network hardware and integrations with other business systems.

Convision

Convision Systems GmbH
Gablonzstraße 9 · D-38114 Braunschweig
Tel. +49(0)531/26450 - 0 · Fax +49(0)531/26450-10
info@convision.com · www.convision.com
Remote video transmission with long term and event driven recording. Live video image transmission, alarm messages or status reports can be send by Email, SMS or FTP. Display via standard internet browser.

Everfocus Electronics AG

Albert-Einstein-Str. 1 · 46446 Emmerich
Tel. +49(0)2822/9394-0 · Fax +49(0)02822/9394-95
info@everfocus.de · www.everfocus.de
Digital video technology, video remote surveillance, video surveillance

MINTRON

MINTRON ENTERPRISE CO. LTD.
No. 123, Wu-Kung 1 Rd., Wu-Ku Industrial Park,
Taipei 248, Taiwan
Tel. +886 2 22990277 · Fax +886 2 22989375
service@mintron.com.tw · www.mintron.com
Skype: mintron3601
Manufacturer of extensive range CCD cameras and board type cameras. OEM & ODM projects are welcomed.

Dallmeier

Dallmeier electronic GmbH & Co. KG
Cranachweg 1 · 93051 Regensburg
Tel. +49(0)941/8700-0 · Fax +49(0)941/8700-180
info@dallmeier.com · www.dallmeier.com
Video: digital storage systems, image transmission, available through specialized retailers

eyevis
PERFECT VISUAL SOLUTIONS

eyevis GmbH
Hundschleestr. 23 · D-72766 Reutlingen
Tel. +49(0)7121/43303-0 · Fax +49(0)7121/43303-22
info@eyevis.de · www.eyevis.de
Large surface displays of security information in control rooms

MOBOTIX
Security-Vision-Systems

MOBOTIX AG
Security-Vision-Systems
Kaiserstrasse · D-67722 Langmeil
Tel. +49 (0) 6302/9816-0 · Fax +49 (0) 6302/9816-190
info@mobotix.com · www.mobotix.com
HiRes Video Solutions – high resolution, digital & cost effective recording

DEKOM
VISIONS AND SOLUTIONS

DEKOM Video Security & Network GmbH
Hoheluftchaussee 108 · D-20253 Hamburg
Tel. +49(0)40/4711213-0 · Fax +49(0)40/4711213-33
info@dekom-security.de · www.dekom-security.de
www.divicro.de – Offices in Munich, Stuttgart, Cologne, Erkelenz, Bremen, Magdeburg and Berlin.
Your reliable partner and provider of professional network video products and complete system solutions.

Genetec

Genetec
2280 Alfred-Nobel Blvd
Suite 400, Montreal, Quebec H4S 2A4, Canada
Tel.: +1/514 332-4000 · Fax: +1/514 332-1692
info@genetec.com · www.genetec.com
License Plate Recognition, IP Security Solutions for Video Surveillance, and Access Control

MONACOR
INTERNATIONAL

MONACOR INTERNATIONAL
Zum Falsch 36 · 28307 Bremen
Tel. +49(0)421/4865-0 · Fax +49(0)421/488415
info@monacor.de · www.monacor.com
Video monitoring components and systems

Video Technology



opto-system-technik
Video-Vertriebsgesellschaft mbH
Planiger Straße 34 · D-55545 Bad Kreuznach
Tel. +49(0)671/4830-10 · Fax +49(0)671/4830-11
info@opto-system-technik.de
www.opto-system-technik.de
Distributor of SONY, SANYO, Pelco,
Dedicated Micros and EverFocus

Video Technology



VICON Deutschland GmbH
Kornstieg 3 · D-24537 Neumünster
Phone: +49(0)4321/879-0 · Fax +49(0)4321/879-97
info@vicon-cctv.de · www.vicon-cctv.de
VICON as one of the world's leading independent manufacturers of CCTV equipment, offers a complete portfolio of the most advanced video management products.



Video Technology



PENTAX Imaging Systems GmbH
Security Systems Division
Julius-Vosseler-Str. 104 · D-22527 Hamburg
Tel. +49(0)40/561 92-109 · Fax +49(0)40/561 92-334
ssd@pentax.de · www.pentax.de
CCTV lenses for video surveillance, image processing, accessories for CCTV lenses

Video Technology



VIDEOR E. Hartig GmbH
Carl-Zeiss-Str. 8 · 63322 Rödermark/Germany
Tel. +49(0)6074/888-300 · Fax +49(0)6074/888-100
security@videor.com · www.videor.com
Distribution of complete product ranges for video security and video networking

Time + Access

Cichon+Stolberg GmbH
Wankelstraße 47-49, 50996 Köln
Tel. +49(0)2236/397-200 · Fax +49(0)2236/61144
info@cryptin.de · www.cryptin.de
Operational data collection, time recording, access control

Video Technology



PIEPER GMGH
Binnerheide 8 · D-58239 Schwerte
Tel. +49(0)2304/4701-56 · Fax +49(0)2304/4701-77
info@pieper-video.de · www.pieper-video.de
System suppliers of general and industrial video technology, focussing on the security and surveillance sectors, as well as quality control and process control applications.

Be Part of the Section

Just send a mail to
heiko.baumgartner@wiley.com
We will be glad to advise you!

Time + Access

deister electronic GmbH
Hermann-Bahlsen-Str. 11
D-30890 Barsinghausen
Tel. +49(0)5105/516-01 · Fax +49(0)5105/516-217
info@deister-gmbh.de · www.deister.com
access control; vehicle identification; biometric verification; guard tour systems; storing and management of keys and valuables

Video Technology



Samsung Europe
Hillswood Drive 1000
Chertsey, Surrey KT16 0PS
United Kingdom
Tel.: +44 1932 455308
steseurity@samsung.com · www.samsungsecurity.com
Samsung is one of the fastest growing professional security brands in Europe and provides a complete range of security solutions that are suitable for a wide range of applications.

Video Technology



VTQ Videotronik GmbH
Grüne Straße 2 · D-06268 Querfurt
Tel. +49 (0) 34771-5 10 · Fax +49 (0) 34771-2 20 44
main@vtq.de · www.vtq.de
systems for digital and analogue wireless video, audio and data transmission, COFDM modulation, MPEG2 compression, directional radio systems, Diversity systems

Zeit + Zutritt

DigiMem Deutschland Ltd & Co KG
Büro Wiesbaden: Didierstraße 7 · D-65203 Wiesbaden
Tel: +49 (0)611 710 9949 · Fax: +49 (0)611 710 9952
david@digimem.eu · www.digimem.eu
Digimem is the appointed agency of Datakey Electronics (USA) and provides full bi-lingual sales and service support for German, Swiss and Austrian customers. Supply of Datakey Keys and Tokens, accessories and periphery to OEMs. Support with the integration of these components into an application to ensure a turnkey system.

Video Technology



Sanyo Video Vertrieb AG
An der Strusbek 31 · 22926 Ahrensburg · Germany
Tel. +49 4102 4798 0 · Fax +49 4102 4798 10
info@santec-video.com · www.santec-video.com
Video monitoring technology · Video-over-IP
Outdoor IR sensors · Planning and Services

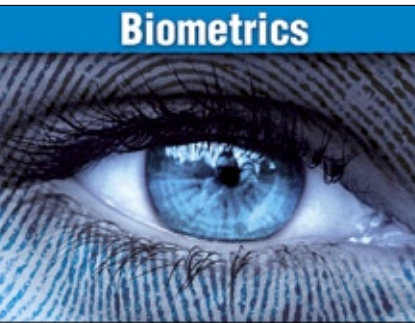

Time + Access

FEIG ELECTRONIC GMBH
Lange Straße 4 · 35781 Weilburg
Tel. +49(0)6471/3109-44 · Fax +49(0)6471/3109-99
obid@feig.de · www.feig.de
Electronic locking systems, identification, access control, access road control

Video Technology



viasys Intelligent Video GmbH
Koselstraße 20, D-60318 Frankfurt am Main
Tel. +49 (0)69/7191 388 – 0
Fax +49 (0)69/7191 388 – 66
jourdan@viasys-iv.com · www.viasys-iv.com
Intelligent video sensors (3D, direction, sensitivity), reliable alarms, especially outdoors, connection to Alert Centre

Biometrics



Ident Technologies GmbH
Rudower Chaussee 29 · D-12489 Berlin
Tel. +49(0)30/63922568 · Fax +49(0)30/63922569
info@identtechnologies.de · www.identtechnologies.de
We create biometric Systems, to make our life easier – the fingerprint will be our key.

Time + Access

Gantner Electronic GmbH
Montafonerstraße 8 · A-6780 Schruns
Tel. +43 5556 73784-542 · Fax +43 5556 73784-8000
info@gantner.com · www.gantner.com
access control solutions/biometrics, time management, data capture, locking systems

Time + Access



ISGUS
UNTERNEHMENSGRUPPE

ISGUS GmbH
Oberdorferstr. 18-22
78054 Villingen-Schwenningen
Tel. +49(0)7720/393-0 · +49(0)7720/393-184
info@isgus.de · www.isgus.de
Operational data capture, personnel scheduling,
time management, access control

Fire Protection



Fire Protection



Kidde
A UTC Fire & Security Company

Kidde Brand- und Explosionsschutz GmbH
Harkortstraße 3 · 40880 Ratingen
Tel. +49(0)2102/5790-0 · Fax +49(0)2102/5790-109
info@kidde.de · www.kidde.de
Fire detection and extinguishing technology ·
high sensitive smoke detection · fire protection
systems for server cabinets and IT rooms ·
explosion suppression systems · Explosion venting

Time + Access



LEGIC
innovation in ID technology

LEGIC Identystems Ltd
Binzackerstrasse 41 · CH-8620 Wetzikon
Switzerland
Phone +41 44 933 64 64 · Fax +41 44 933 64 65
www.legic.com · info@legic.com
Designer and manufacturer of 13.56 MHz
contactless smart card technology (read/write chip
sets, security modules and transponder chips)

Fire Protection



C-TEC (Compuionics Limited)
Stephens Way, Wigan, WN3 6PH United Kingdom
Tel. +44(0)1942/403810 · Fax +44(0)1942/829867
sales@c-tec.co.uk · www.c-tec.co.uk
Fire Panels, Fire Alarm Accessories, Voice Alarm
Systems, Fire Telephone Systems, Call Systems,
Power Supplies

Fire Protection



NOTIFIER
by Honeywell

Notifier Sicherheitssysteme GmbH
Berliner Str. 91 · D-40880 Ratingen
Tel. +49(0)2102/70069-0 · Fax +49(0)2102/70069-44
info@notifier.de · www.notifier.de
fire alarm systems, early fire detection

Time + Access



pcs

PCS Systemtechnik GmbH
Pfälzer-Wald-Straße 36 · 81539 München
Tel. +49(0)89/68004-550 · Fax +49(0)89/68004-555
intus@pcs.com · www.pcs.com
time recording, access control, BDE/MDE, biometric,
video, SAP, Infor-Baan

Be Part of the Section



Just send a mail to
heiko.baumgartner@wiley.com
We will be glad to advise you!

Fire Protection



STOBICH
FIRE PROTECTION
INVESTMENT FOR YOUR PROTECTION

Stöbich Brandschutz GmbH
Pracherstieg 6 · 38644 Goslar · Germany
Tel.: +49 (0) 53 21 / 57 08 - 0
Fax: +49 (0) 53 21 / 57 08 - 991
info@stoebich.com · www.stoebich.com

- Textile fire and smoke protection closures
- Flexible and static smoke barriers
- Conveyor system closures
- Control units and 400-volt-emergency backup systems
- Fire protection hoods for electric devices

Time + Access



phg
Die richtige Verbindung

phg Peter Hengstler GmbH + Co. KG
Dauchinger Str. 12 · D-78652 Deißlingen
Tel. +49(0)7420/89-0 · Fax +49(0)7420/89-59
datentechnik@phg.de · www.phg.de
RFID components for access control, timekeeping, factory
data collection, canteen data, leisure applications, surface-
mounted devices, flush-mounting components, biometrics,
identification media and accessories

Fire Protection



JOO
detectomat

detectomat GmbH
An der Strusbek 5 · D-22926 Ahrensburg
Tel. +49(0)4102/2114-60
Fax +49(0)4102/2114-670
info@detectomat.de · www.detectomat.de
Fire alarms, Fire warning systems, Fire protection,
security systems

Fire Protection



Teckentrup
Türen · Tore · Zargen

Teckentrup GmbH & Co.KG
Tel. +49 (0) 5246/504-0
Fax +49 (0) 5246/504-30
www.teckentrup.biz · info@teckentrup.biz
Fire protection doors and gates T30/T60/T90,
security doors (resistance class WK 1 – WK 4),
sound insulated doors (up to Rw 57 dB),
bullet-proofed doors, smoke-proof doors

Time + Access



primion
Technology that cares

primion Technology AG
Steinbeisstraße 2-4 · D-72510 Stetten a.K.M.
Tel. +49(0)7573/952-0 · Fax +49(0)7573/92034
info@primion.de · www.primion.de
Time management, access control and
management, staff deployment planning,
graphic alarm management, SAP communications
solutions, pass and ID card production, Biometrics

Fire Protection



ESSER
by Honeywell

Novar GmbH a Honeywell Company
Dieselstraße 2 · D-41469 Neuss
Tel. +49(0)2137/17-600 · Fax +49(0)2137/17-286
info@esser-systems.de · www.esser-systems.de
Fire alarm systems, security systems

Fire Protection



WAGNER

WAGNER Group GmbH
Schleswigstraße 1-5 · 30853 Langenhagen
Tel. +49(0)511/97383-0 · Fax +49(0)511/97383-140
info@wagner.de · www.wagner.de
Hamburg · Berlin · Leipzig · Hannover
Mülheim/R. · Frankfurt · Stuttgart · München
Fire alarm systems and extinguishing technology,
fire prevention, integral security

Time + Access



wanzl
Zutrittskontrollen

Wanzl Metallwarenfabrik GmbH
Bubesheimer Str. 4 · 89340 Leipheim · Germany
Tel. +49(0)8221/729-6416
Fax +49(0)8221/729-90416
zutrittskontrollen@wanzl.de
www.wanzl-zutrittskontrollen.com
Personal guidance systems, barriers, security
turnstiles, electronic entrance systems

Fire Protection



HEKATRON
Ihr Partner für Brandschutz

Hekatron Vertriebs GmbH
Brühlmatten 9 · 79295 Sulzburg
Tel. +49(0)7634/500-0 · Fax +49(0)7634/6419
info@hekatron.de · www.hekatron.de
Fire alarm systems, Smoke switch systems,
Smoke alarms, Safety linkage systems



Industrial Safety

Evac+Chair International Ltd
Tel +44 (0)121-706-6744
www.evachair.co.uk · info@evachair.co.uk



European Training Division
c/o ESE International BV, DG Veldhoven
Tel. +31 (0)402553700
Tel. +49 (0)6238 984 6810 (Germany)
info@ese-int.nl
Evac+Chair Training Solutions

Hazardous Goods



DÜPERTHAL Sicherheitstechnik GmbH & Co. KG
Mainparkstr. 6-10 · 63801 Kleinostheim
Tel. 0 60 27 / 403-0 · Fax 0 60 27 / 403-121
info@dueperthal.com · www.dueperthal.com
Fire protection rooms, hazardous materials storage, safety cabinets, environmental safety, fire protection

Plant Safety



Pepperl+Fuchs GmbH
Lilienthalstraße 200 · 68307 Mannheim
Tel. 0621/776-1111 · Fax 0621/776-27-1111
fa-info@de.pepperl-fuchs.com
www.pepperl-fuchs.com
Security sensors, inductive, capacitive, opto-electronic and ultrasonic sensors, vision sensors, identification systems, interface modules

Be Part of the Section



Just send a mail to
heiko.baumgartner@wiley.com

We will be glad to advise you!

Hazardous Goods



Köttermann GmbH & Co KG
Industriestr. 2-10 · 31311 Uetze/Hänigsen
Tel. +49(0)5147/976-0 · Fax +49(0)5147/976-844
systemlabor@koettermann.de
www.koettermann.com
Hood equipment, laboratory furnishings, media connections (supply and disposal)

BUSINESSPARTNER on the Web: www.pro-4-pro.com/sicherheit



Dear Readers,
Who is Who in Security:
BUSINESSPARTNER is the purchasing section of qualified companies for direct contact. Under the supplier's logo you will find the company name, telephone number, fax, e-mail, web address and the core competence.

BUSINESSPARTNER on the internet:
www.PRO-4-PRO.com/security. There you will find all companies as well – with links to their websites. You belong to the most qualified suppliers as well and set great store by 20,000 opinion leaders reaching with each print issue?

ADT Security Dt.	34	Fluidmesh Networks Europe	6	Niche Events	8
Apollo Fire Detectors	6, 41	Genetec	34	Norbain SD	41
Arecont	21	Geutebrück	5	Notifier 43	
Avigilon	23, 24, 34	Gunnebo	6	Novar a Honeywell Company	44
AxxonSoft	18, Outside Back Cover	Honeywell Security	30	Panasonic	7, 36, 40
Basler	41	IER Transport Ind. Division	41	Pelco	35
Bosch Security Systems	7, 17, 28, 32	L-3 Communications Security and Detection Systems	6	Salto Systems	22
Brickcom Corporation	15	Legic Identsystems	3, 34	Samsung Techwin Europe	10, 34, 40, 41, Inside Front Cover
CBC	7, 33	Merit Li-Lin	40	Sicurit Alarmitalia	19, 20
Communication Networks	40	Milestone Systems	7, 26, Front Cover	Suprema	41
Dallmeier electronic	38	Minimax	40	UBM Information	13
Deister electronic	39	Mintron	37	Videotec	9
EADS	6	Morpho	7, 41	Xtralis	43
EVACChair	43	Mühlbauer	6		
Eyevis	25	Nedap	7		
FLIR Commercial Vision Systems	40, 42	Netcomm	7		

IMPRINT

Published by

GIT VERLAG Publishing Ltd.
A Wiley Company
Roesslerstrasse 90
64293 Darmstadt · GERMANY
Tel.: +49 (0) 6151 8090 0
Fax: +49 (0) 6151 8090 144
info@gitverlag.com · www.gitverlag.com

Managing Directors

- Dr. Michael Schön
- Bijan Ghawami

Publishing Directors

- Dr. Heiko Baumgartner
Tel.: +49 (0) 61 51/80 90 137
heiko.baumgartner@wiley.com

• Steffen Ebert

Tel.: +49 (0) 61 51/80 90 130
steffen.ebert@wiley.com

Sales Managers

- Regina Berg-Jauernig
Tel.: +49 (0) 61 51/80 90 149
regina.berg-jauernig@wiley.com
- Katina Leondaris
Tel.: +49 (0) 61 51/80 90 107
katina.leondaris@wiley.com
- Dr. Michael Leising
Tel.: +49 (0) 36 03/89 31 12
- Manfred Höring
Tel.: +49 (0)61 59/50 55

Editorial

- Matthias Erler
Tel.: +49 (0) 6723/9 94 99 82
matthias.erler@wiley.com

Editorial Assistant

- Nina Wehle
Tel.: +49 (0) 61 51/80 90 214
nina.wehle@wiley.com

Production

- Christiane Potthast
- Andi Kettenbach (Layout)
- Claudia Vogel (Sales Administrator)

European Representatives

- Dave Harvett, Direct Media
Tel.: +44 (0) 121 705 2120
daveharvett@btconnect.com
- Oliver Haines, Impressive Marketing
Tel.: +44 (0) 1743 369611
impressive.marketing@virgin.net

Bank Account

Commerzbank AG Darmstadt, Germany
Account No. 01.715.501 00
Routing No. 508 800 50

GIT SECURITY is published 6 times per year.

Subscription 2011

6 issues 72.00 €, single copy 14.50 € plus postage. Pupils and Students receive a discount of 50% at sight of a valid certificate. Subscription orders valid until cancelled, notices 6 weeks before end of the year. Subscription orders can be revoked within 1 week in writing. Dispatch complaints are possible only within 4 weeks after publishing date.

The publishing house is granted the exclusive right, with regard to space, time and content to use the works/ editorial contributions in unchanged or edited form for any and all purposes any number of times itself, or to transfer the rights for the use of other organizations in which it holds partnership interests, as well as to third parties. This right of use relates to print as well as electronic media, including the Internet, as well as databases/data carriers of any kind.

All names, symbols etc. mentioned and/or printed in this issue may be registered trademarks of their respective owners.

Printrun: 20,000

Cover Page Layout

Elli Palzer · elke.palzer@wiley.com

Printed by

pva Druck und Mediendienstleistungen GmbH
D-76829 Landau/Pfalz

Printed in Germany
ISSN 2190-4367



axxon

Intellect™

Enterprise

Video Management Platform

**outstanding
high-performance
customized**

pos

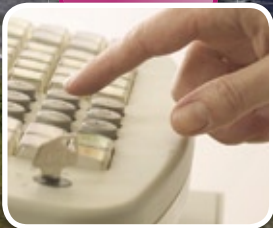

auto



face



atm

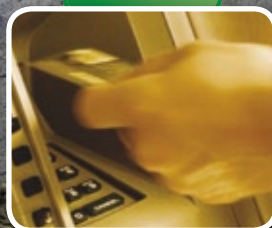

railway



our optional Intellect modules



Video Surveillance and Security Solutions

Find further information on our products

www.axxonsoft.com